

April 2003

Features

- Broadband 1 to 2000 MHz
- Low Power (500 mW)
- 3 Diff Outputs
- 6 Single Outputs
- High Linearity
- IIP3 = +20 dBm
- IIP2 = +50 dBm
- NF = 8 dB
- >40 dB AGC Range
- Ultra Fast AGC
- Gain Tracking Error <1 dB

Applications

- RF Signal Switching
- RF Signal Level Control
- Phased Arrays
- Instrumentation
- ATE
- Base Station RX and TX
- Adaptive Antenna's Systems
- Video Recorders
- RF Signal Distribution
- Multiple Tuners
- Satellite, Cable, Terrestrial Digital TV Multiple Tuners

Ordering Information

| | |
|-------------|--------------------|
| ZL40000/LCE | 28 MLP Tubes |
| ZL40000/LCF | 28 MLP Tape & Reel |

-40°C to +80°C

Description

The ZL40000 is an ultra high linearity RF power divider. The device provides a 75 Ohm Input impedance to a broad band RF input Signal. The signal is buffered through an ultra high linearity 6 dB Gain buffer. This is followed by a power divider which splits the buffered signal into 3 signals. One signal is passed through a 200 Ohm differential output driver. The other two signals are passed through two separate 0 to -40 dB AGC stages before output as two isolated independent differential Signals.

The device is built on Zarlink's 20 GHz Complimentary Bipolar Process.

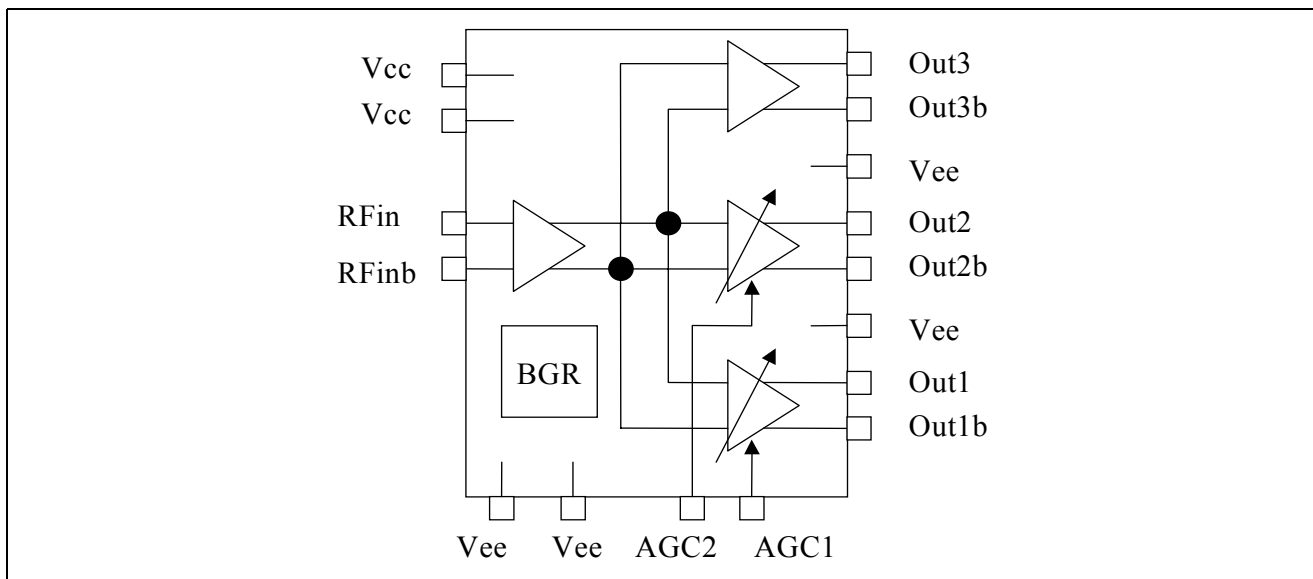

Figure 1 - Functional Block Diagram

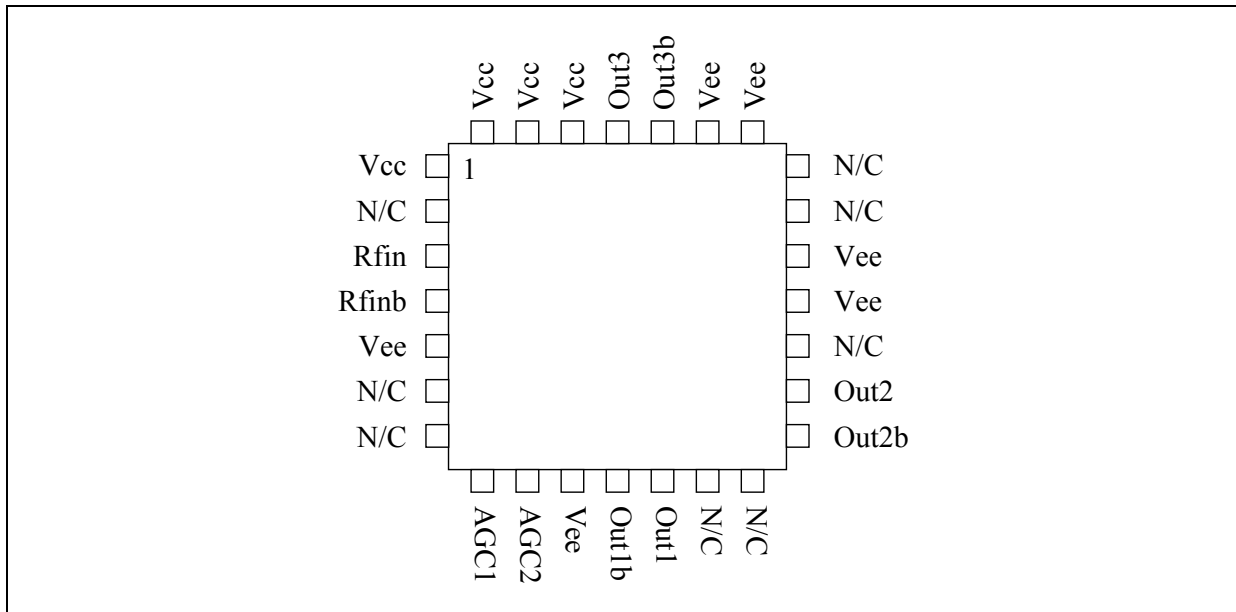

Figure 2 - Pin Diagram

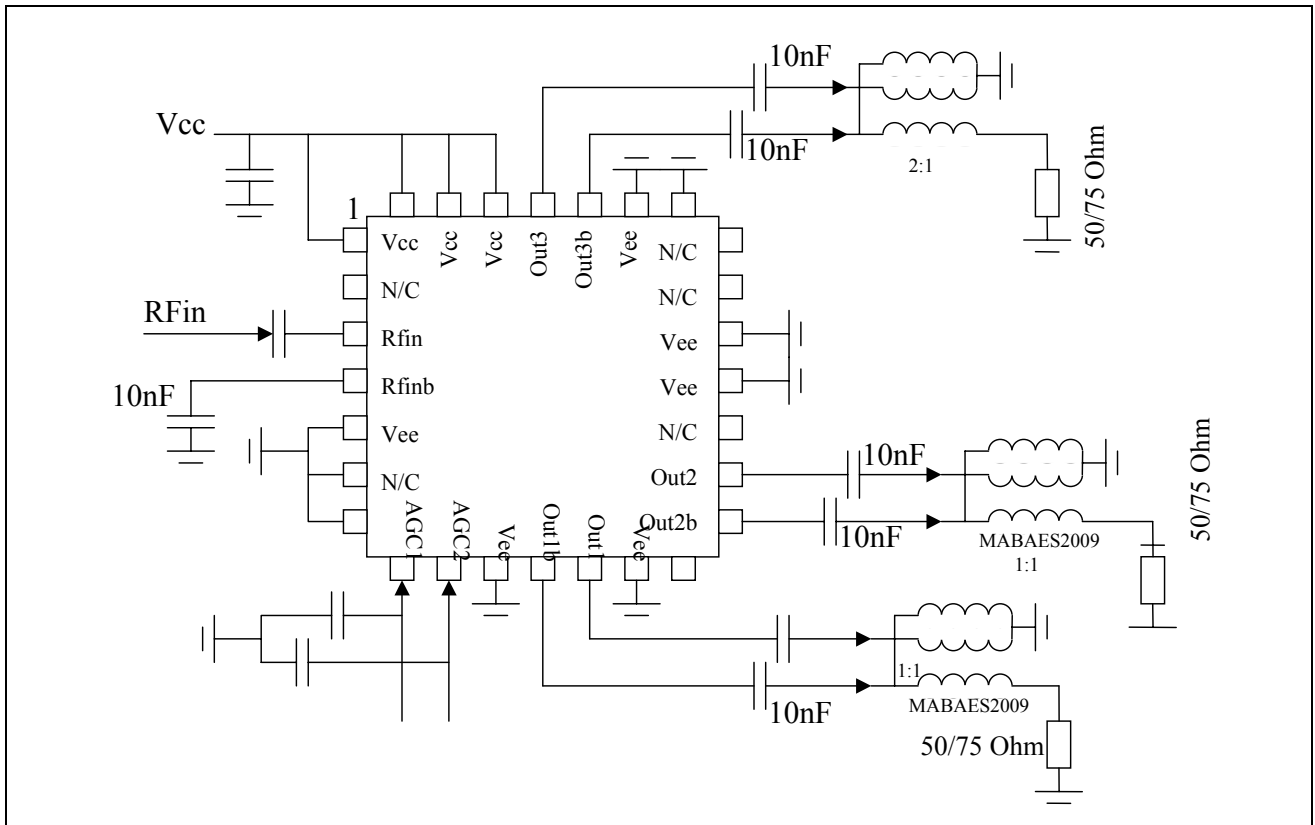

Figure 3 - Application Diagram - A (Differential)

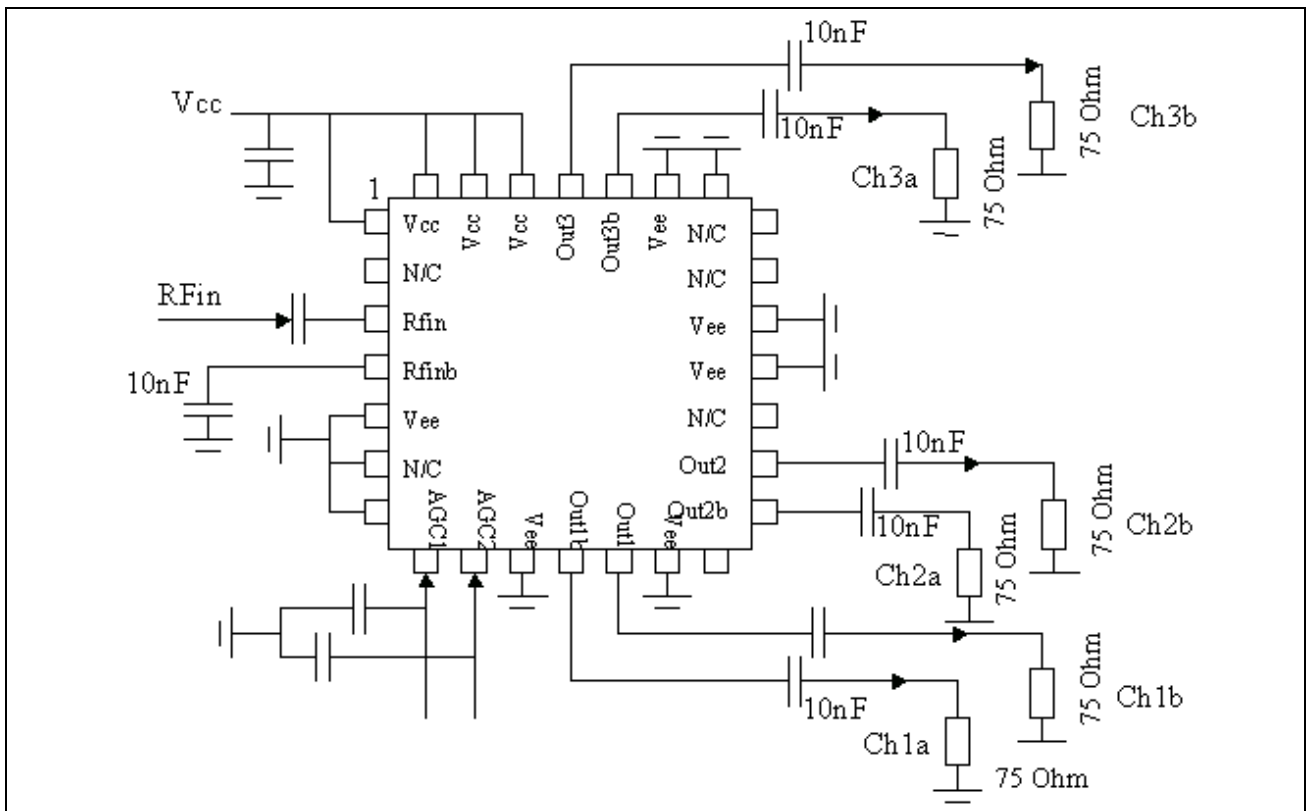

Figure 4 - Application Diagram B (Single Ended)

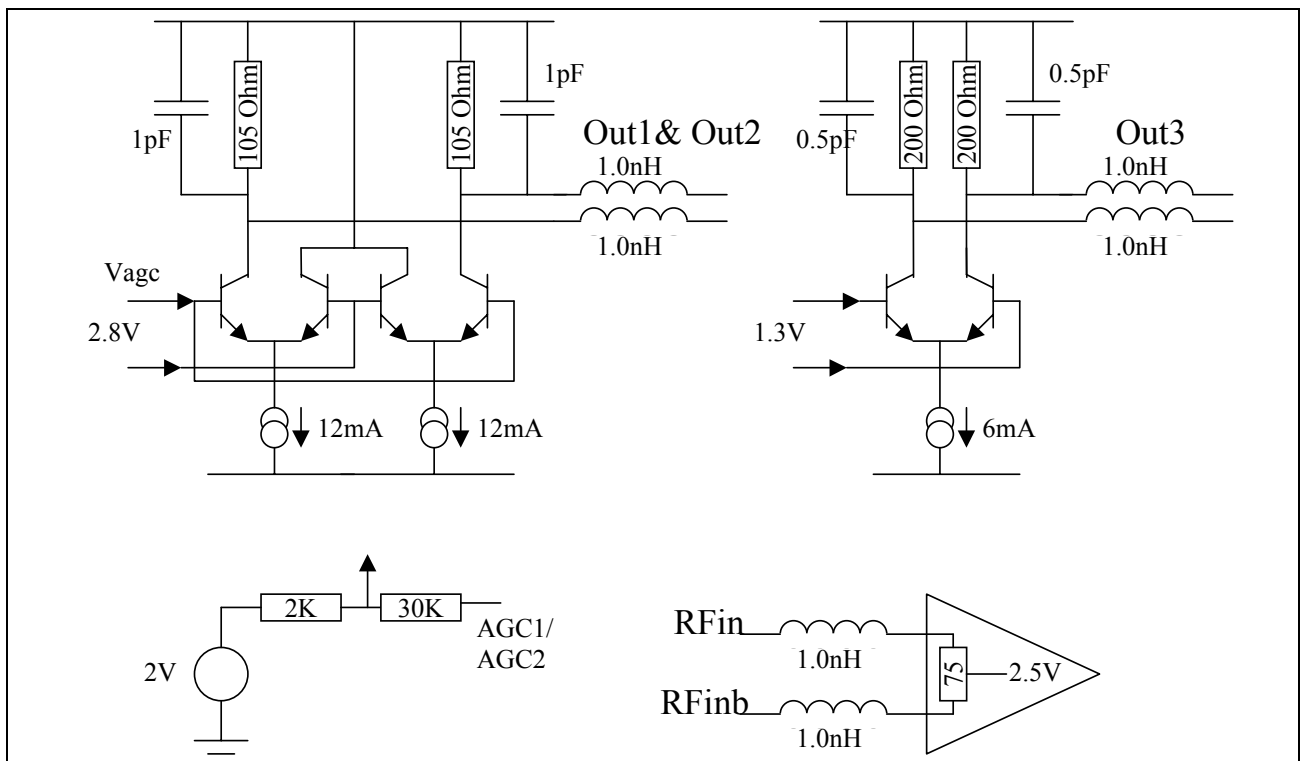

Figure 5 - ZL40000 I/O Circuits

Absolute Maximum Ratings

| Characteristic | Min. | Max. | Units | Comments |
|----------------------|-------|---------|-------|--------------------------|
| Supply Voltage (Vcc) | - 0.5 | 6 | V | |
| RFin | | 12 | dBm | |
| All I/O ports | -0.5V | Vcc+0.5 | V | |
| Storage Temperature | -55 | 150 | °C | |
| Junction Temperature | | 125 | °C | |
| ESD protection | 2KV | | | Mil-std 883B / 3015 cat1 |

Operating Range

| Characteristic | Min | Typ | Max | Units | Comments |
|-------------------------------------|------|-----|------|-------|-------------------|
| Supply Voltage (Vcc) | 4.75 | | 5.25 | V | |
| AGC1 | 0 | | 5.25 | V | |
| AGC2 | 0 | | 5.25 | V | |
| RFin Frequency Range | 0.1 | | 2000 | MHz | |
| Operating Junction Temperature | -40 | | +120 | °C | |
| Junc'n to Amb't resistance Theta Ja | | 50 | | °C/W | 4 layer FR4 Board |
| Junc'n to Case resistance Theta Jc | | 20 | | °C/W | 4 layer FR4 Board |

DC Electrical Characteristics - Vcc=5V +/- 0.25V, Tamb = -40°C to 80°C, unless otherwise specified.

| Characteristic | Min | Typ | Max | Units | Comments |
|----------------------|-----|---------|-----|-------|-----------|
| Supply Current | | 100 | 130 | mA | |
| Power Dissipation | | 500 | 683 | mW | |
| RFin, RFinb DC Level | | Vcc/2 | | V | |
| Out1, Out1b DC Level | | Vcc-1.2 | | V | AGC1 = 0V |
| Out2, Out2b DC Level | | Vcc-1.2 | | V | AGC2 = 0V |
| Out3, Out3b DC Level | | Vcc-0.5 | | V | |

AC Electrical Characteristics - $V_{cc}=5V \pm 0.25V$, $T_{amb} = -40^{\circ}C$ to $80^{\circ}C$, unless otherwise specified.

| Characteristic | Min | Typ | Max | Units | Comments |
|-------------------------------|------|------|------|----------|---|
| Diff RFin impedance | | 75 | | Ohm | |
| S11 | | 6 | | dB | (See Figure 36) (10 MHz to 1000 MHz) |
| Diff Out1 impedance | | 200 | | Ohm | |
| Diff Out2 impedance | | 200 | | Ohm | |
| Diff Out3 impedance | | 400 | | Ohm | |
| S21 Gain1 (Out1/RFin) | 3.5 | 6.5 | 9.5 | dB | 100 Ohm Diff load, AGC1=0V (Max Gain) |
| S21 Gain2 (Out2/RFin) | 3.5 | 6.5 | 9.5 | dB | 100 Ohm Diff load, AGC1=0V (Max Gain) |
| S21 Gain3 (Out3/RFin) | -3.5 | -0.5 | -2.5 | dB | 200 Ohm Diff load, |
| Gain Matching (Gain1 - Gain2) | -0.5 | 0 | 0.5 | dB | AGC1 = AGC2 = 0V (Max Gain) |
| Gain Matching (Gain1- Gain2) | -0.5 | | 0.5 | dB | Gain1 = Gain2 = 5 dB to 0 dB, Figure 16 & Figure 18. |
| Gain Matching (Gain1 - Gain2) | -2 | | 2 | dB | Gain1 = Gain2 = 0dB to -25 dB, Figure 17 & Figure 19 (Temp = 0C to 80C) |
| NF (Out1 & Out2) | | 7.5 | | dB | Figure 32 & Figure 33 (Gain = Max) |
| NF (Out1 & Out2) | | 12 | | dB | Figure 32 & Figure 33 (Gain = 0 dB) |
| NF (Out1 & Out2) | | 15 | | dB | Figure 32 & Figure 33 (Gain = -5 dB) |
| NF (Out1 & Out2) | | 18 | | dB | Figure 32 & Figure 33 (Gain = -10 dB) |
| RFin P-dB compression | -2 | 0 | | dBm | |
| CMRR | | 40 | | dB | |
| AGC Range (Out1 & Out2) | 40 | | | dB | |
| AGC -3 dB BW | | 45 | | MHz | |
| AGC Switching Time | | 15 | | ns | Max Gain to Min Gain (V _{agc} =0.8V to 4.2V) |
| AGC input referred Noise | | 200 | | nV/rt Hz | (Includes 26 dB agc input resistor attenuator) |
| IIP3_100 MHz | | 20 | | dBm | Figure 26 & Figure 27 |
| IIP3_500 MHz | | 17 | | dBm | Figure 26 & Figure 27 |
| IIP3_1000 MHz | | 13 | | dBm | Figure 26 & Figure 27 |
| IIP3 variance / AGC | -1 | | 1 | dB | Gain = 5 dB to - 10 dB, Figure 28 & Figure 29 |
| IIP2_50 MHz | | 55 | | dBm | Figure 20 & Figure 21 (0 dB Gain) |
| IIP2_500 MHz | | 42 | | dBm | Figure 20 & Figure 21 (0 dB Gain) |
| Isolation (Output to Output) | | 50 | | dB | Balanced to Balanced |
| Isolation (output to output) | | 25 | | | Single Ch1 to Single Ch2 Output |
| S21 (Output to Input) | | | -40 | dB | Balanced to Balanced |

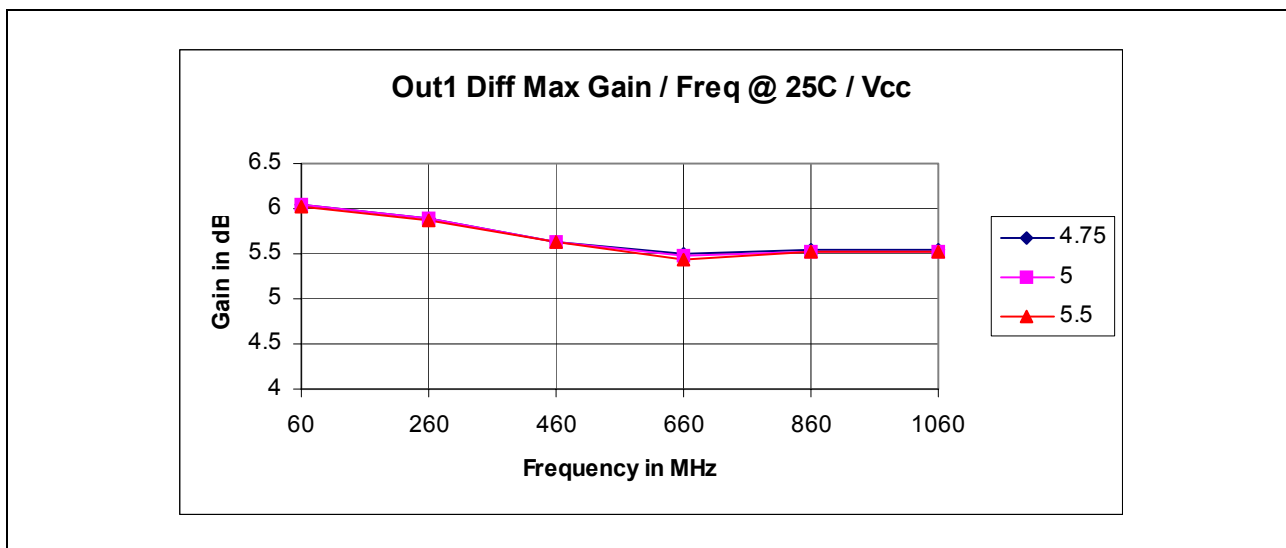

Figure 6 - Typical Ch1&2 Diff Gain / Freq / Vcc @ 25C

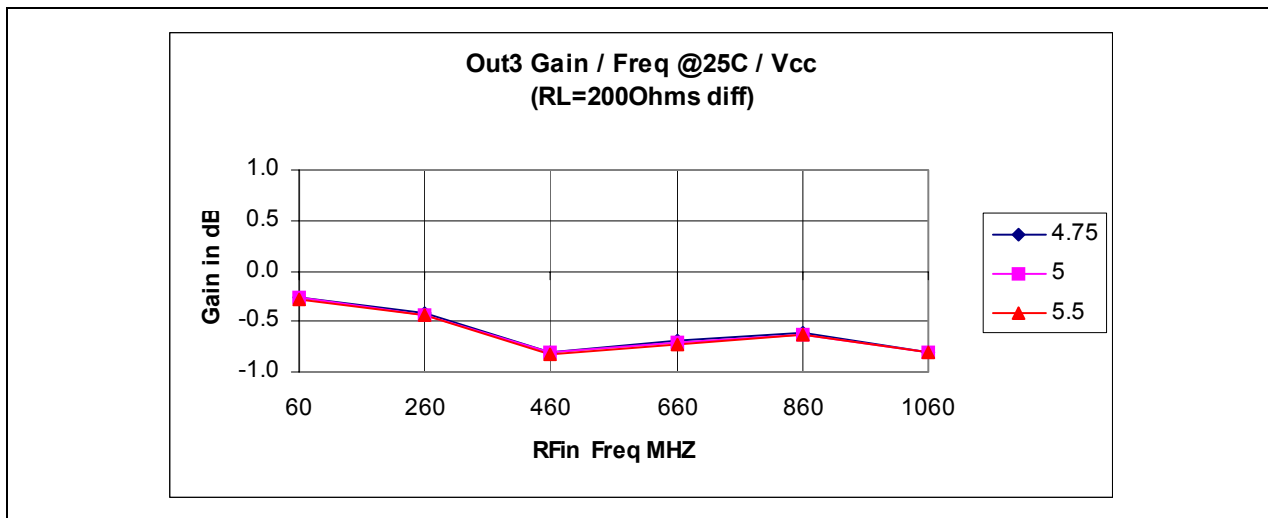

Figure 7 - Typical Ch3 Diff Gain / Freq / Vcc @ 25C

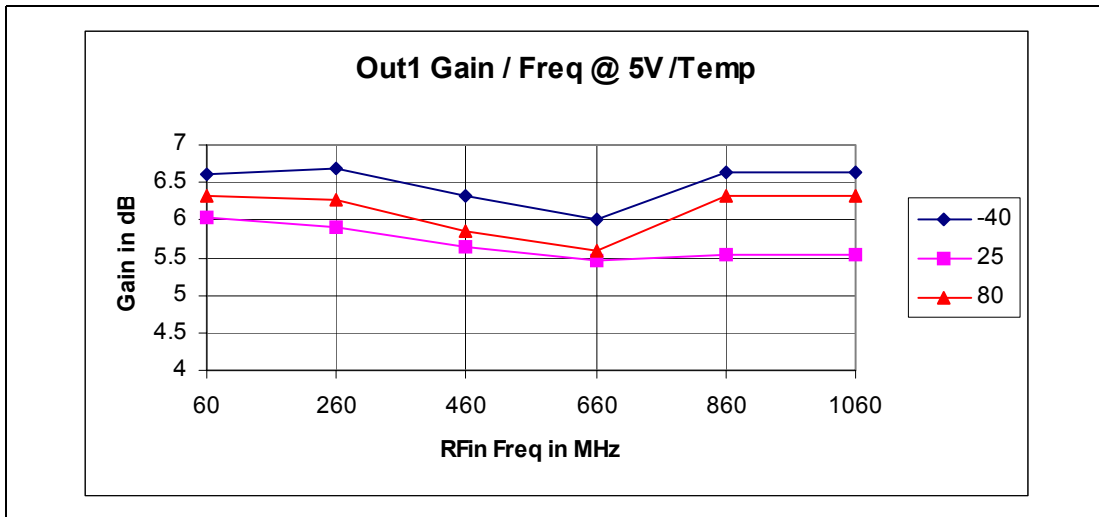

Figure 8 - Typical Ch1 & Ch2 Diff Max Gain / Freq / Temp @ 5V Vcc

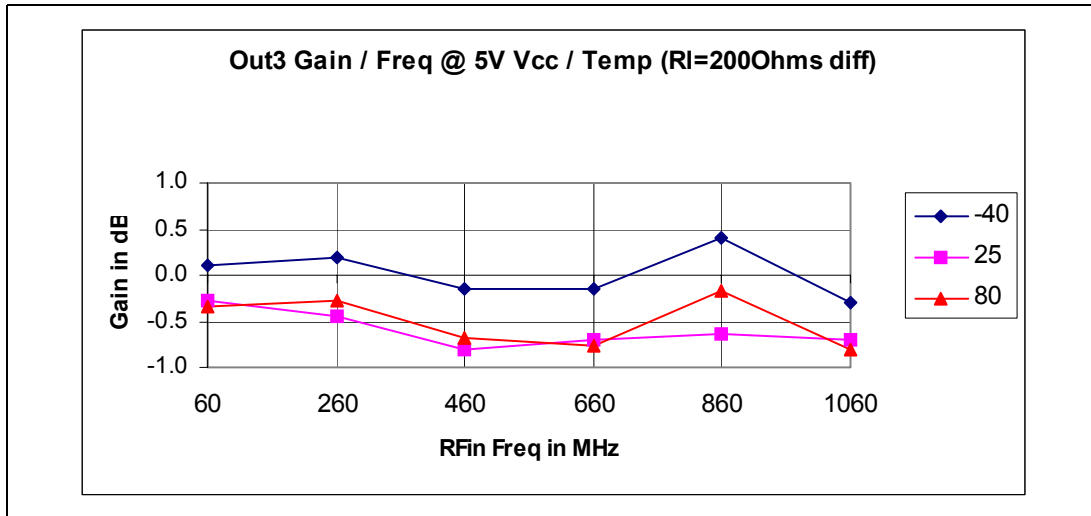

Figure 9 - Typical Ch3 Gain / Freq @ 5V / Temp (R1=200 Ohm)

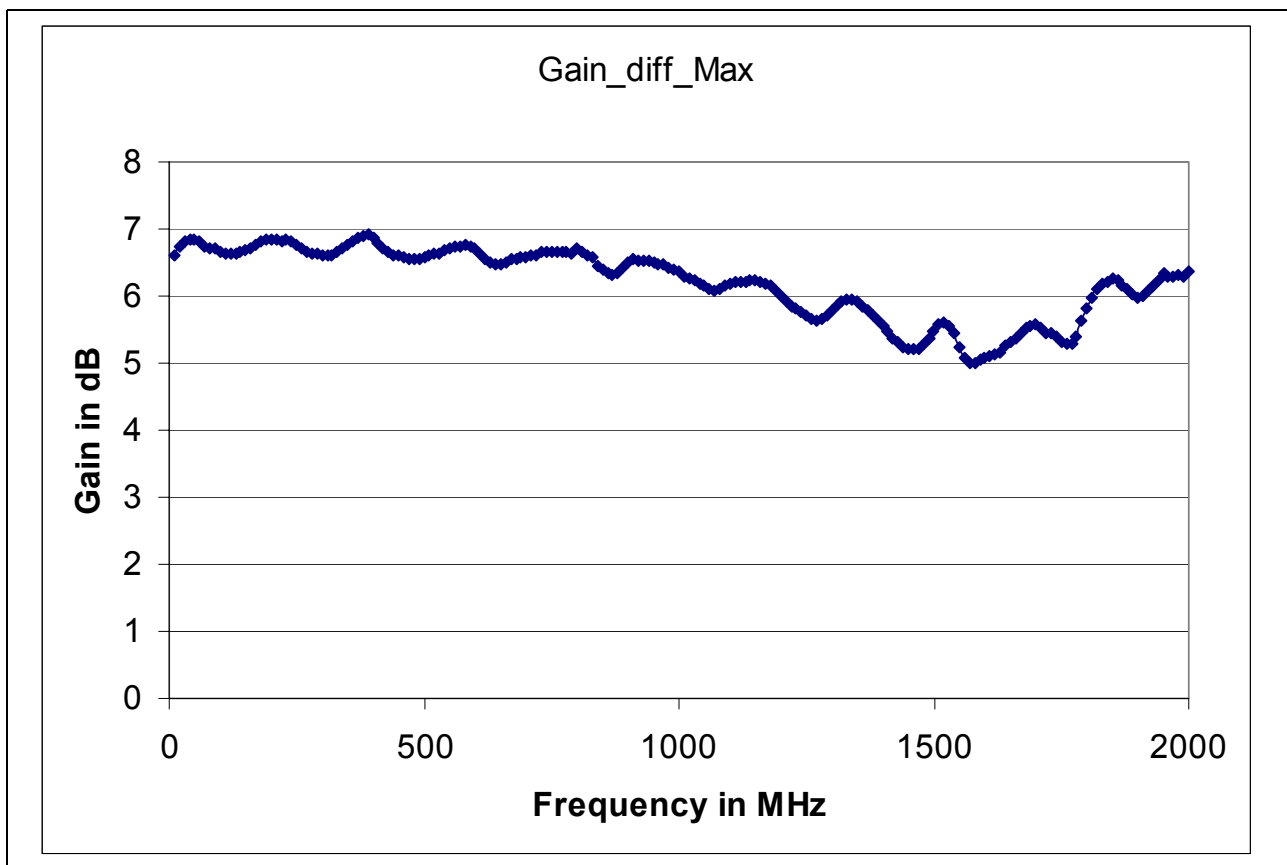

Figure 10 - Typical Diff Max Gain / Frequency

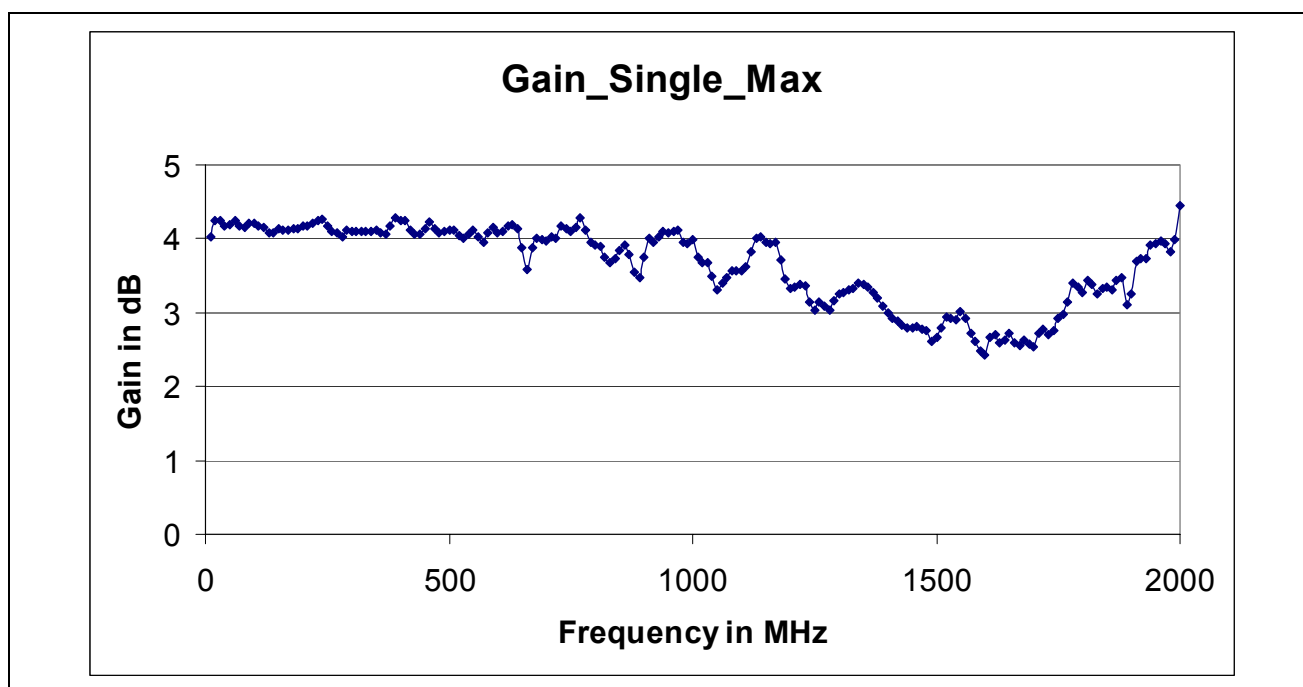

Figure 11 - Typical Single Ended Max Gain / Frequency

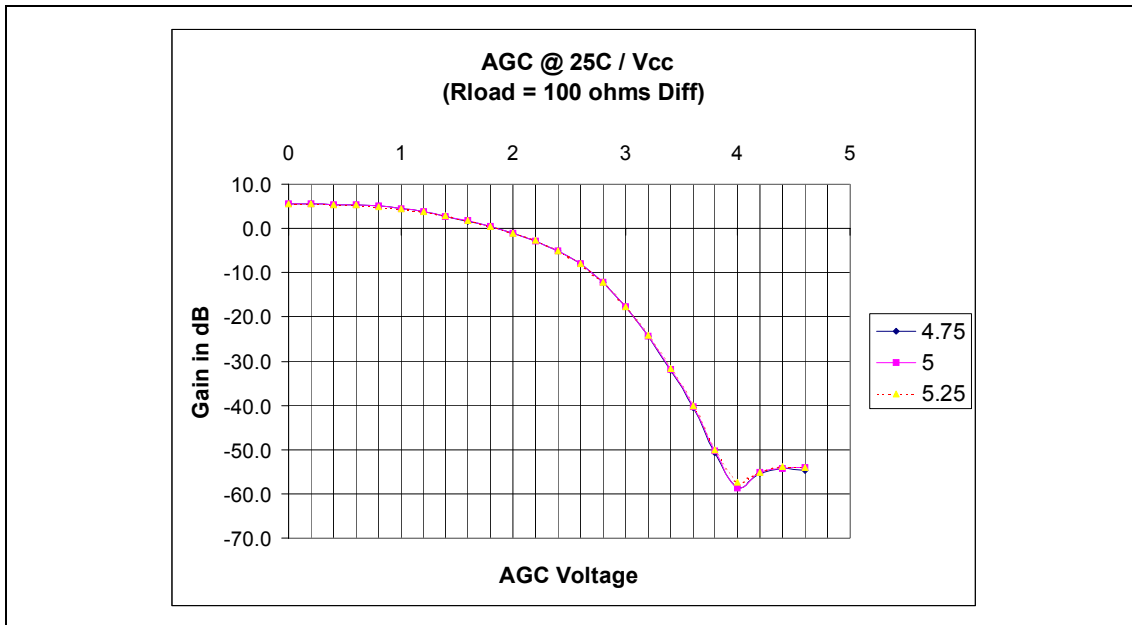

Figure 12 - Typical AGC / VCC @ 25C

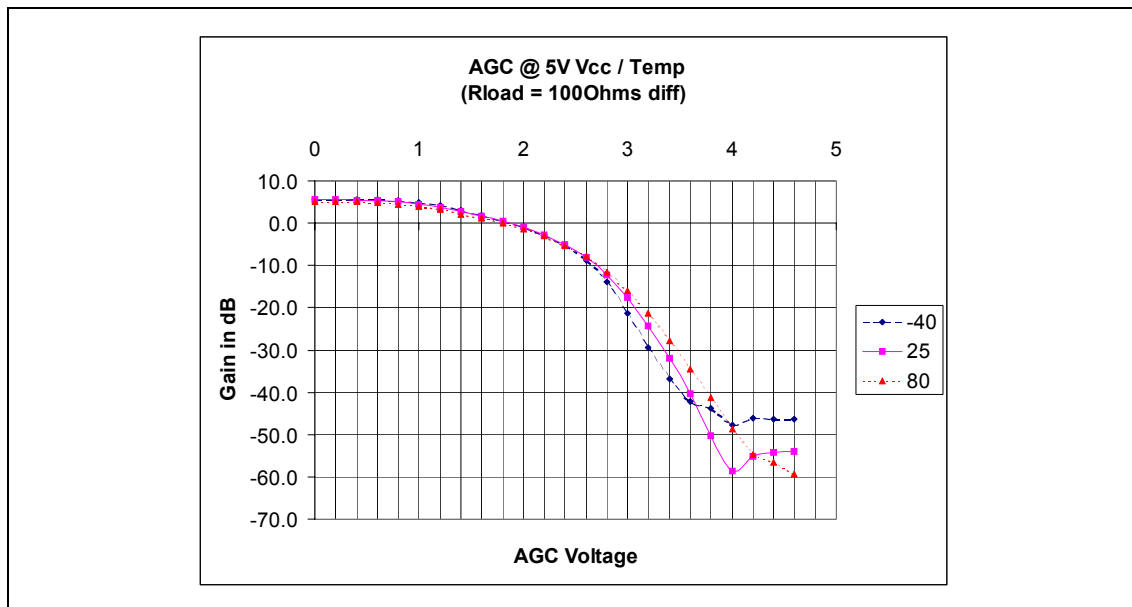

Figure 13 - Typical AGC / Temp @ 5 V Vcc

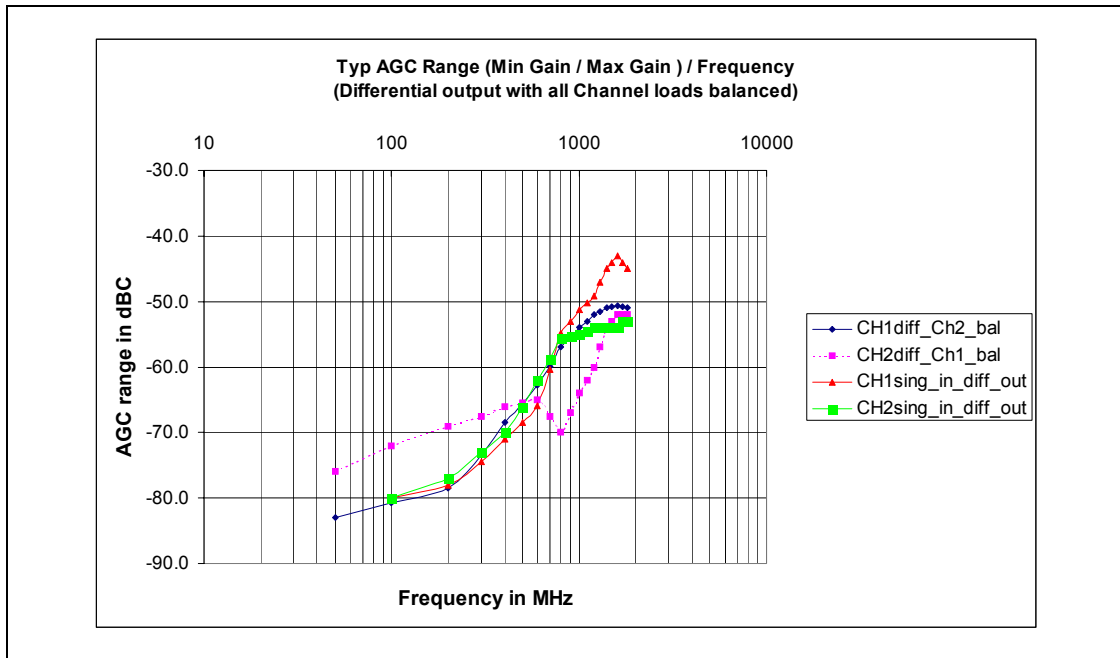

Figure 14 - Typical AGC Range / Frequency (Differential Output with all channel loads balanced)

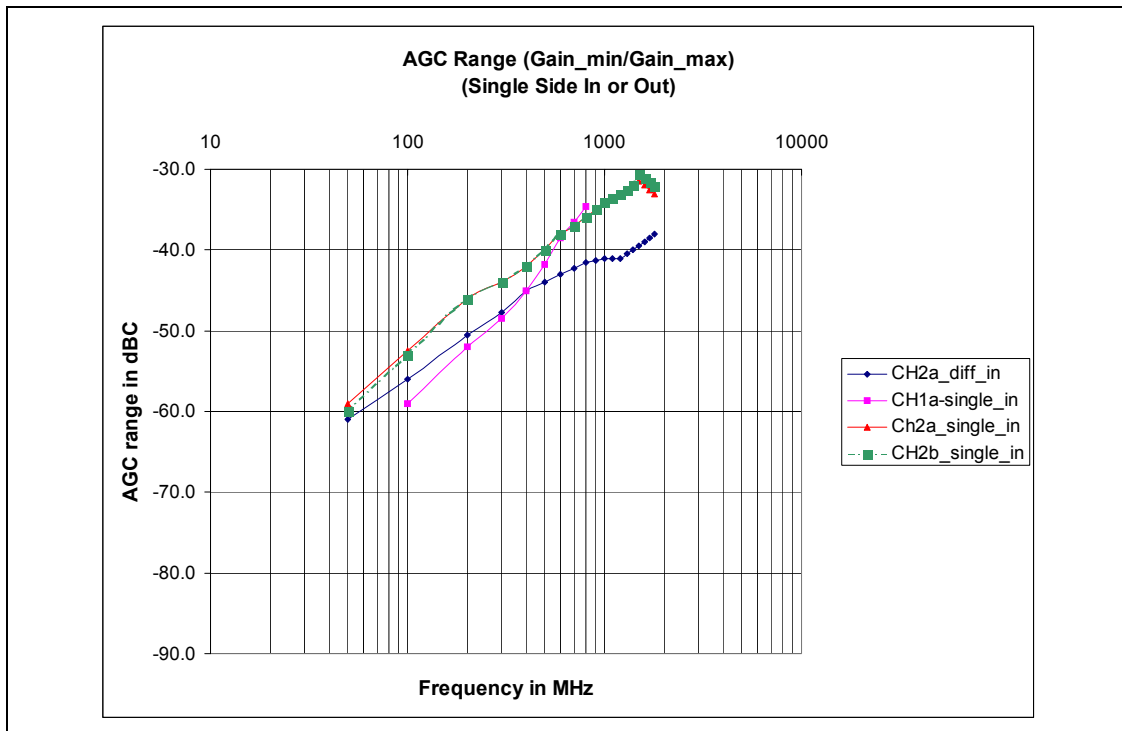

Figure 15 - Typical AGC Range / Frequency (Single Ended output)

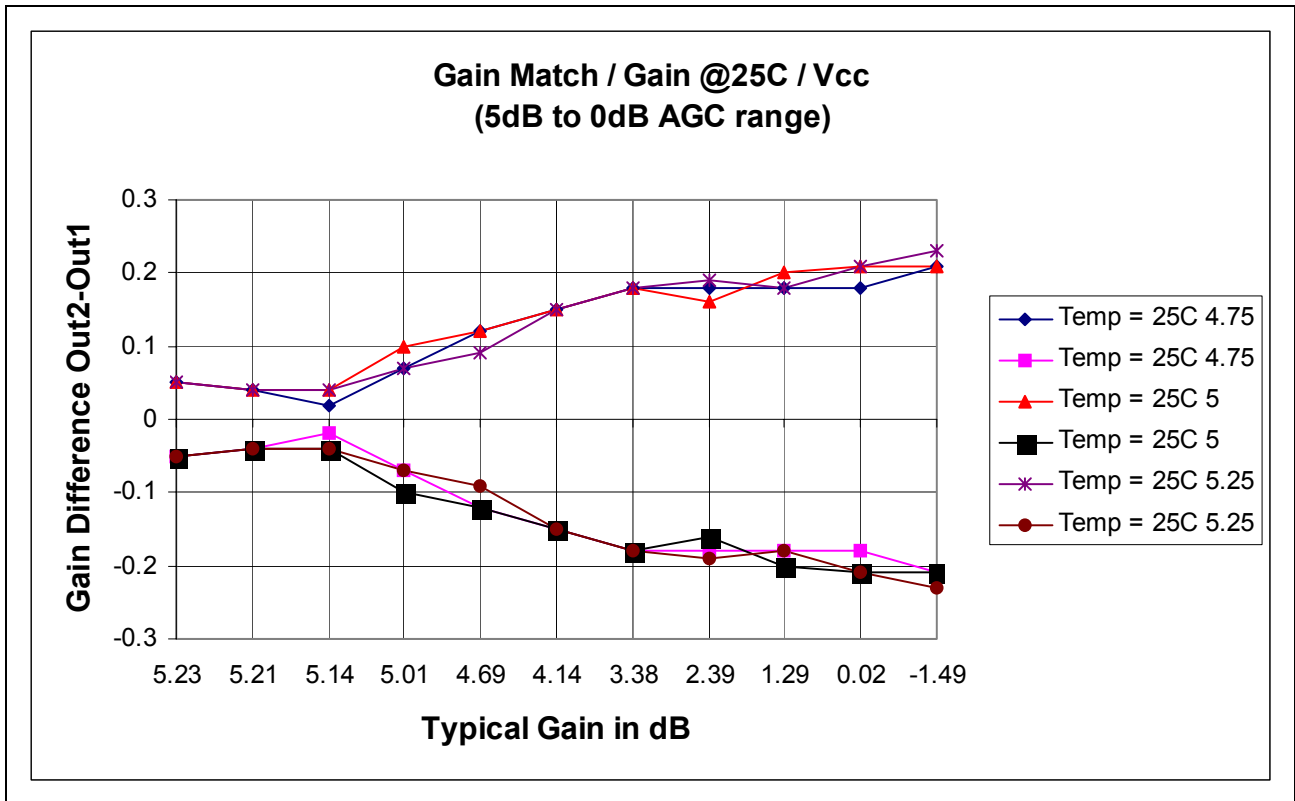

Figure 16 - Typical Gain Matching / AGC @25C / Vcc

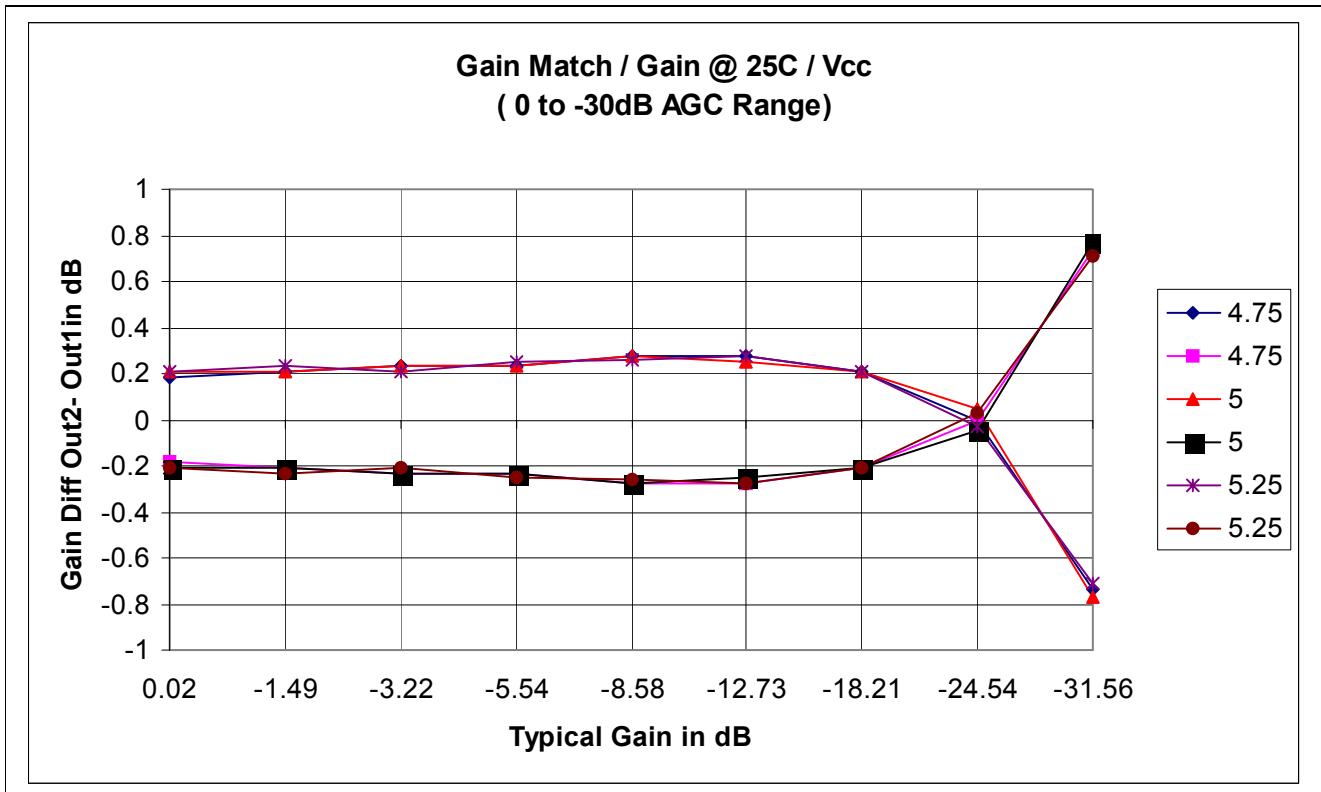

Figure 17 - Typical Gain Match 1 to 2 / Gain @ 25C / Vcc

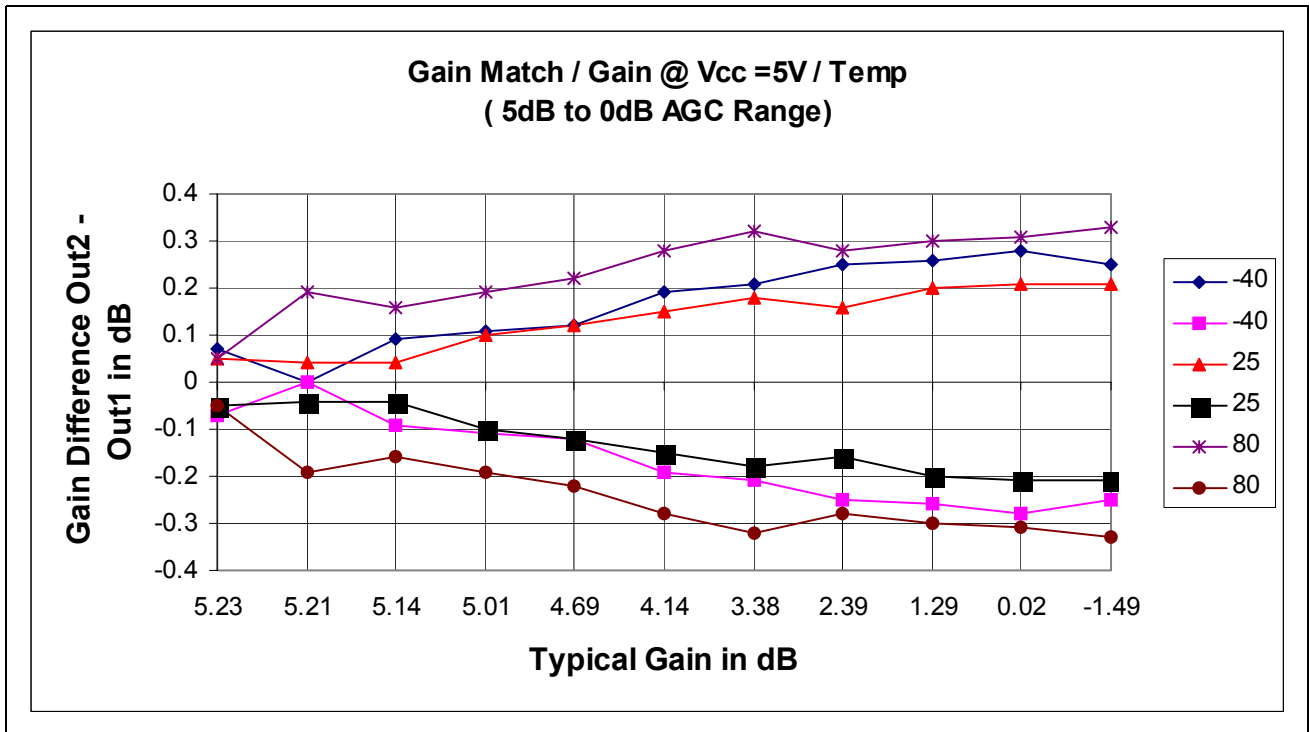

Figure 18 - Typical Gain Matching / AGC @ 5V Vcc / Temp

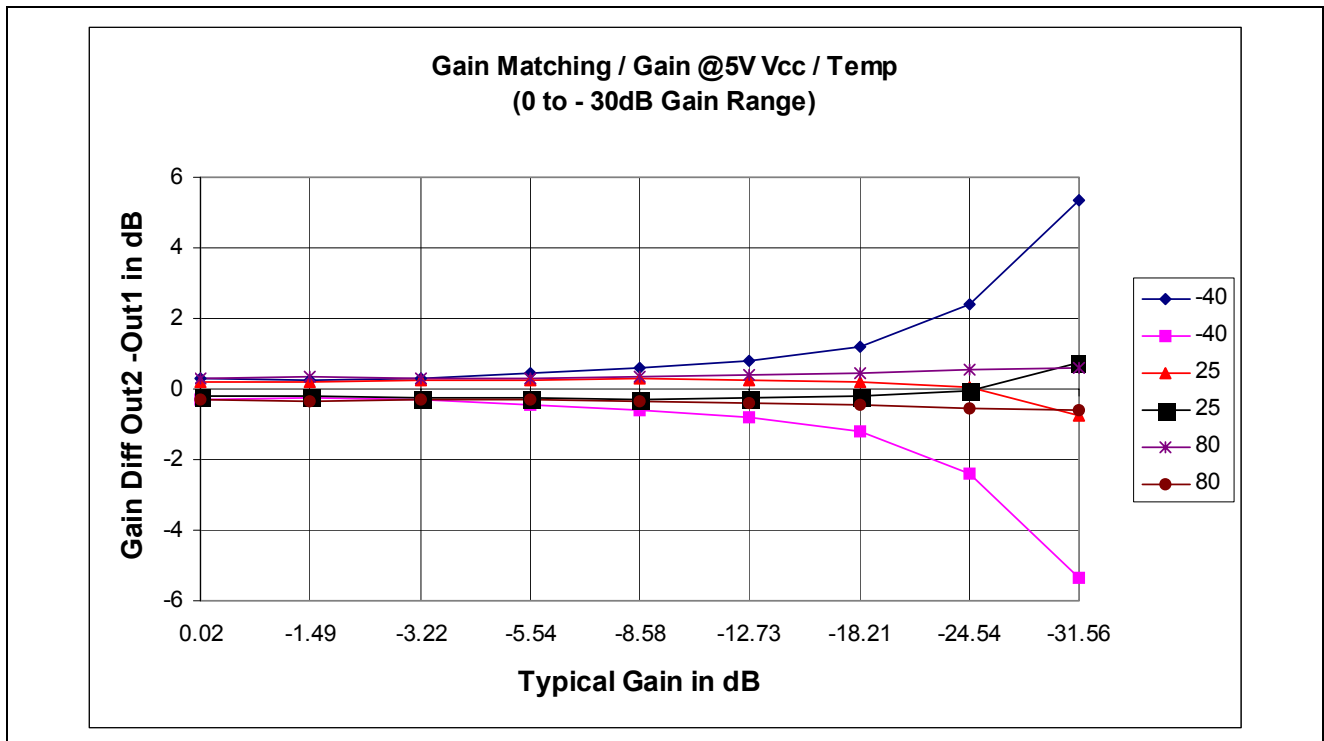

Figure 19 - Typical Gain Matching / AGC @ 5V Vcc / Temp

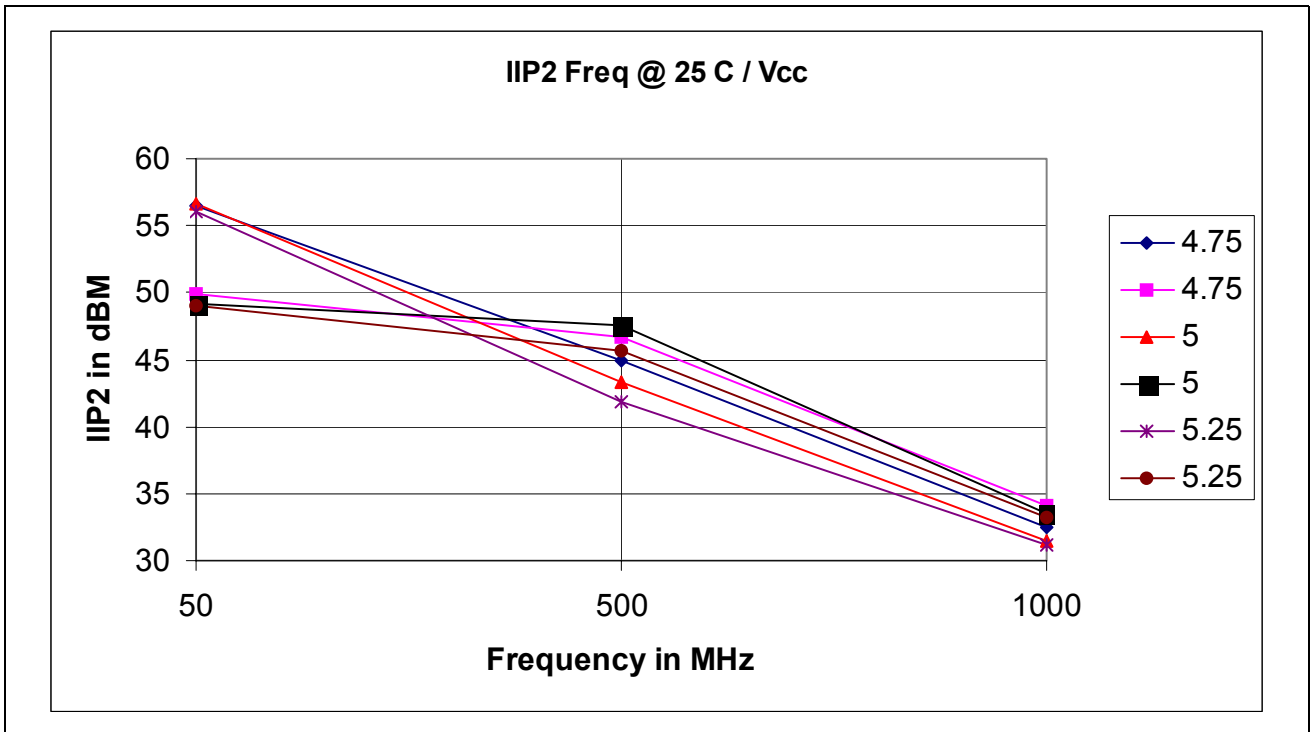

Figure 20 - Typical Out1 @ Out2 IIP2 / Frequency @ Max Gain @ 25C / Vcc

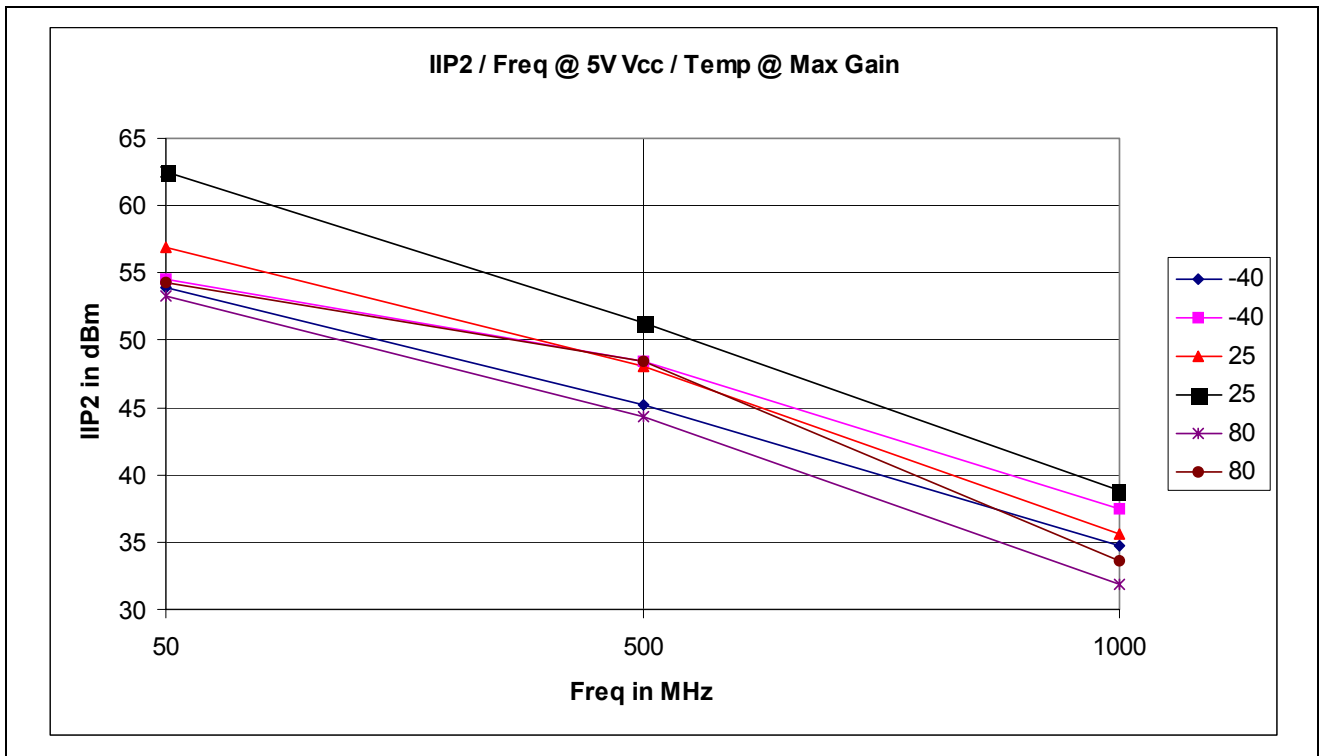

Figure 21 - Typical Out1 @ Out2 IIP2 / Frequency @ Max Gain @ 5V Vcc / Temp

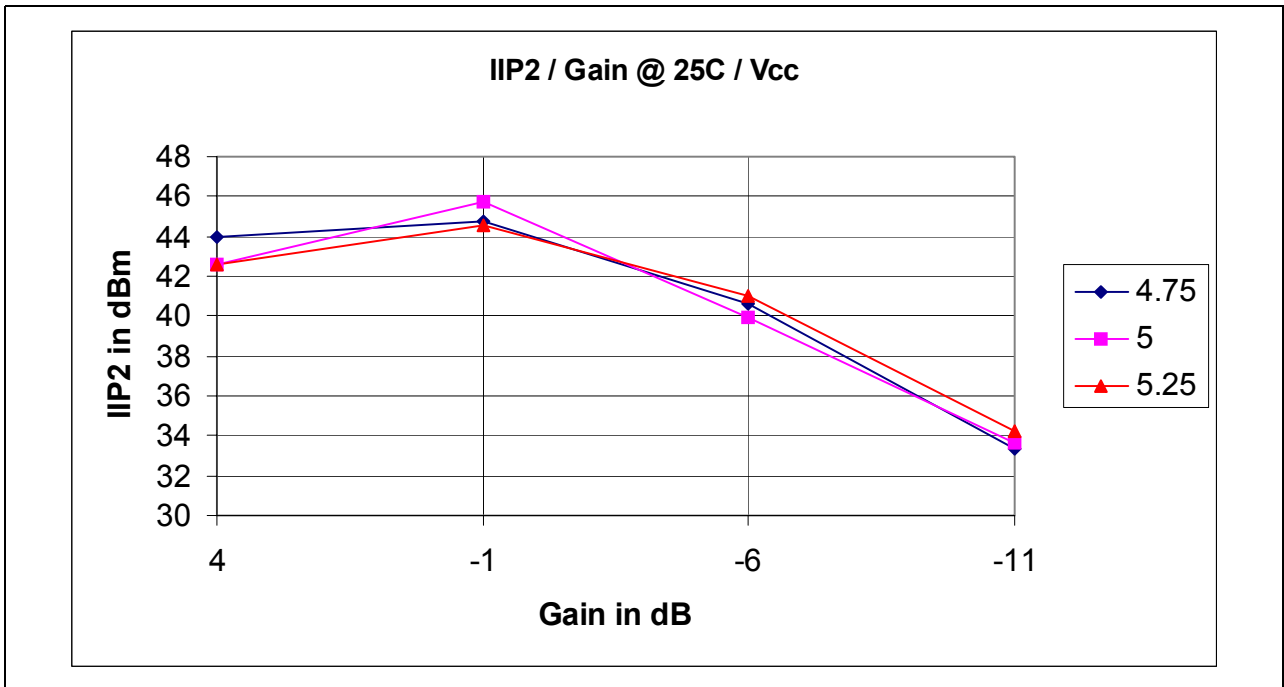

Figure 22 - Typical IIP2 / Gain @ 25C / Vcc @ 500MHz

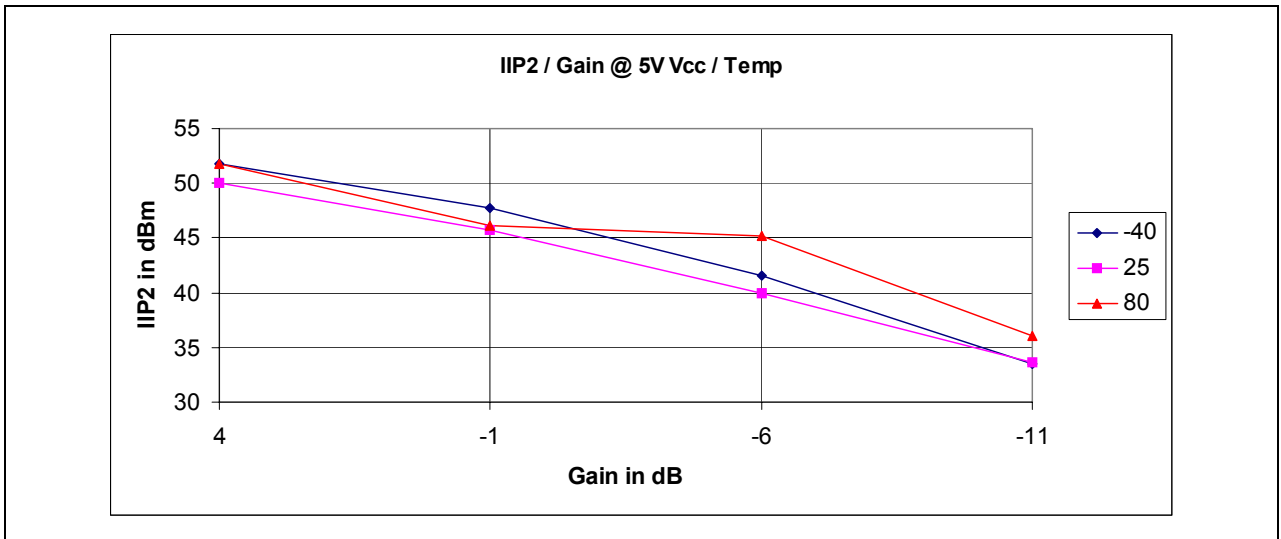

Figure 23 - Typical IIP2 / Gain @ 5V Vcc / Temp @ 500 MHz

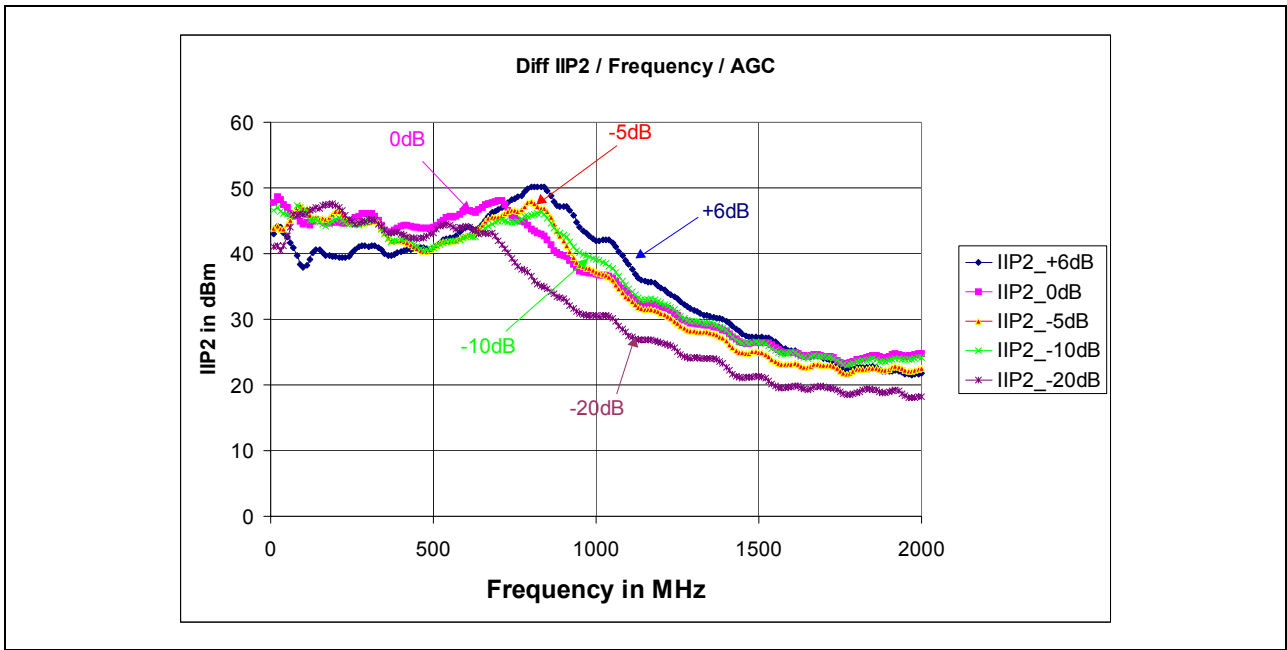

Figure 24 - Typical Differential IIP2 / Frequency / AGC Setting

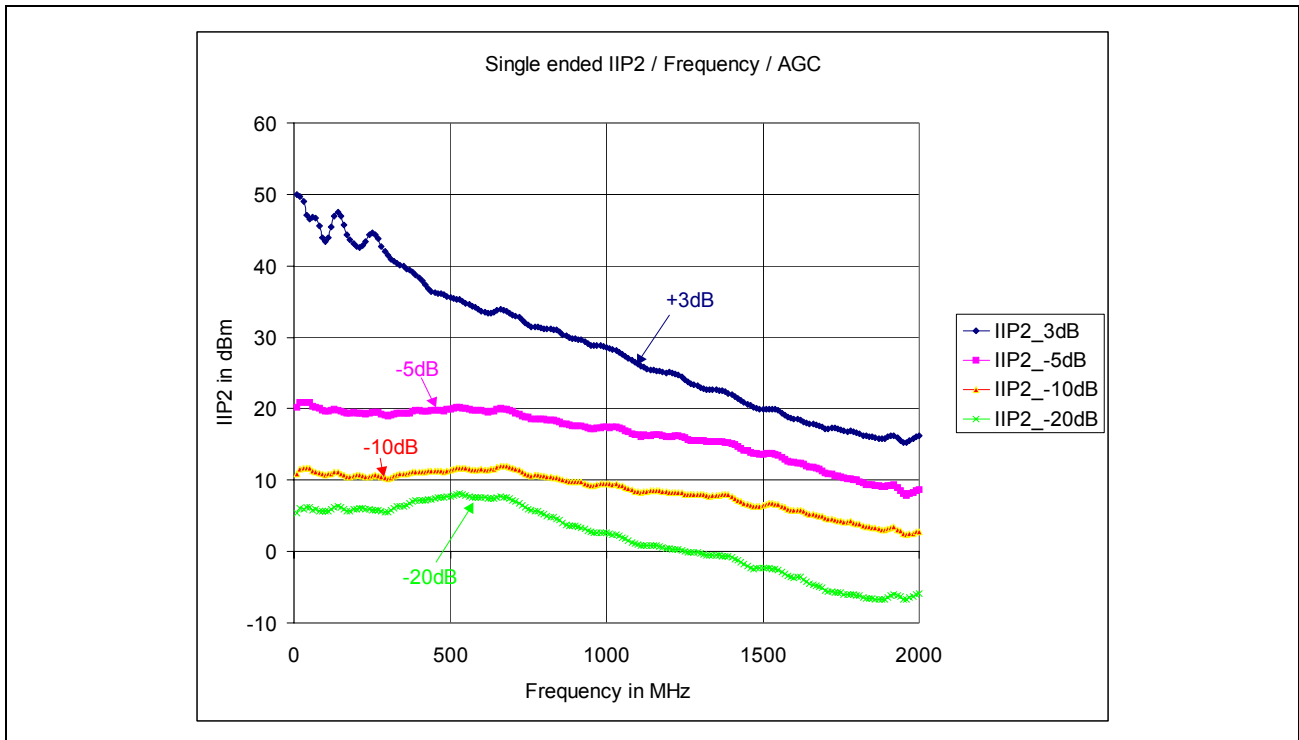

Figure 25 - Typical Single Ended IIP2 / Frequency / AGC

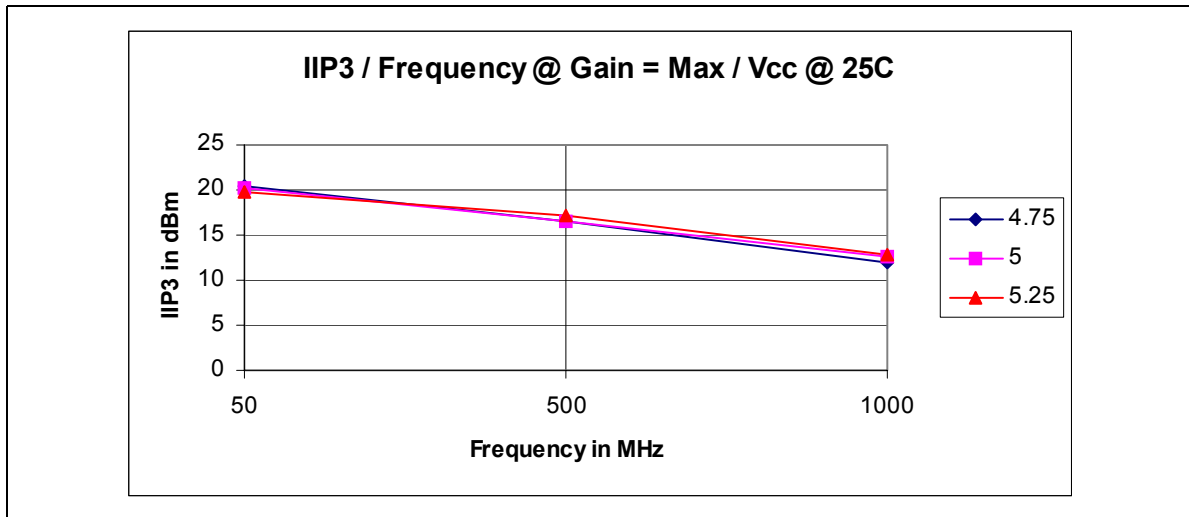

Figure 26 - Typical Out1, Out2 & Out3 IIP3 / Frequency @ Gain = Max / Vcc @ 25C

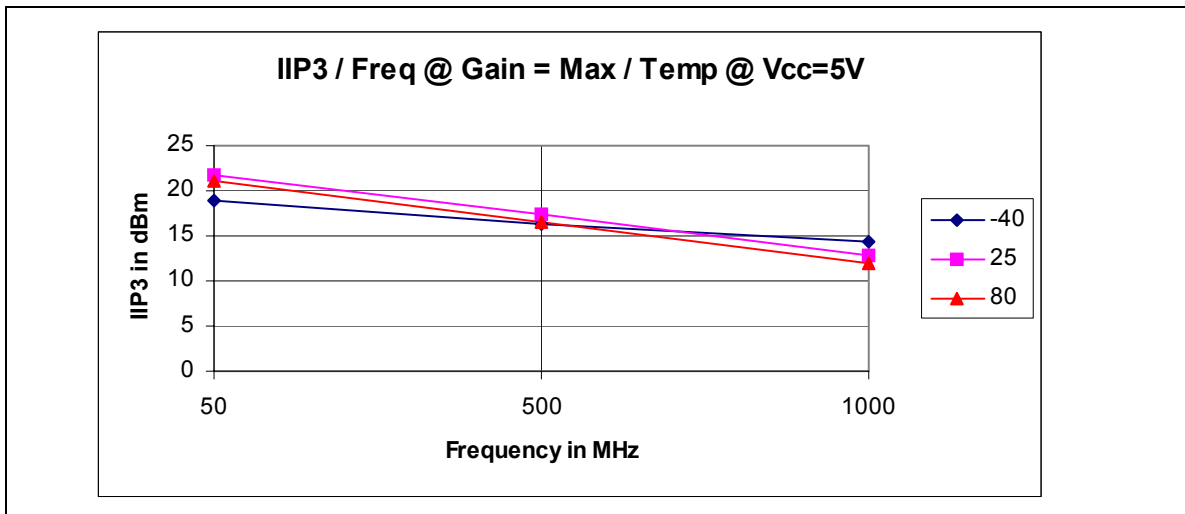

Figure 27 - Typical Out1, Out2 & Out3 IIP3 / Frequency @ Gain = Max / Temp @ 5V Vcc

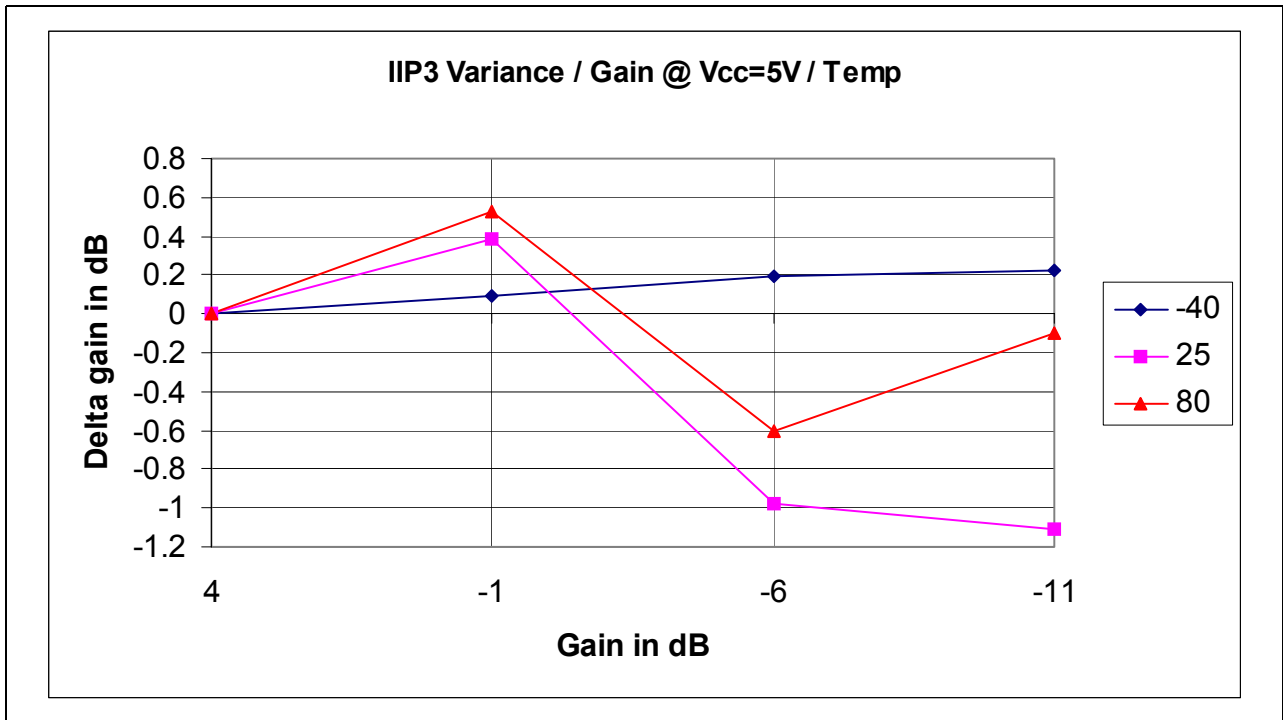

Figure 28 - Typical IIP3 Variance with AGC @ Vcc=5V /Temp @ 400MHz

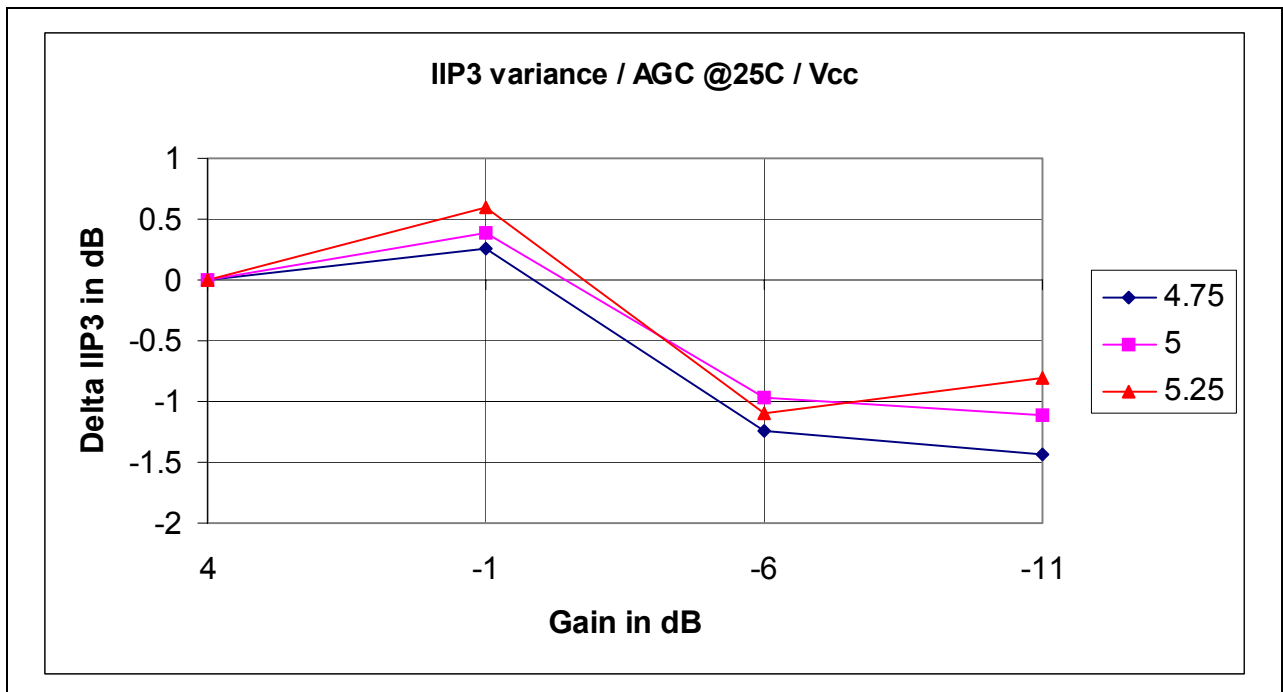

Figure 29 - Typical IIP3 variance with AGC @ 25C / Vcc @ 400 MHz

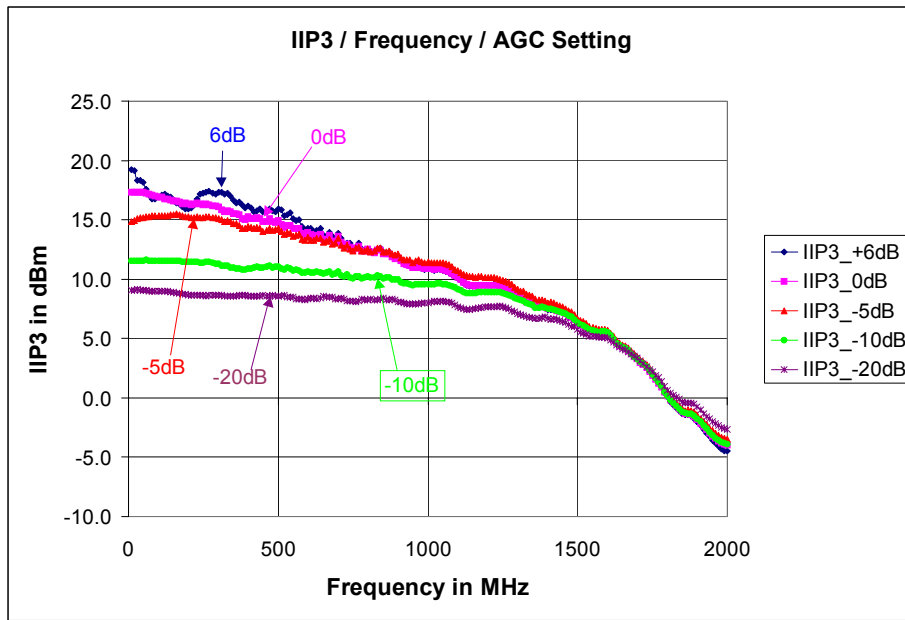

Figure 30 - Typical IIP3 @ Max Gain Differential / Frequency

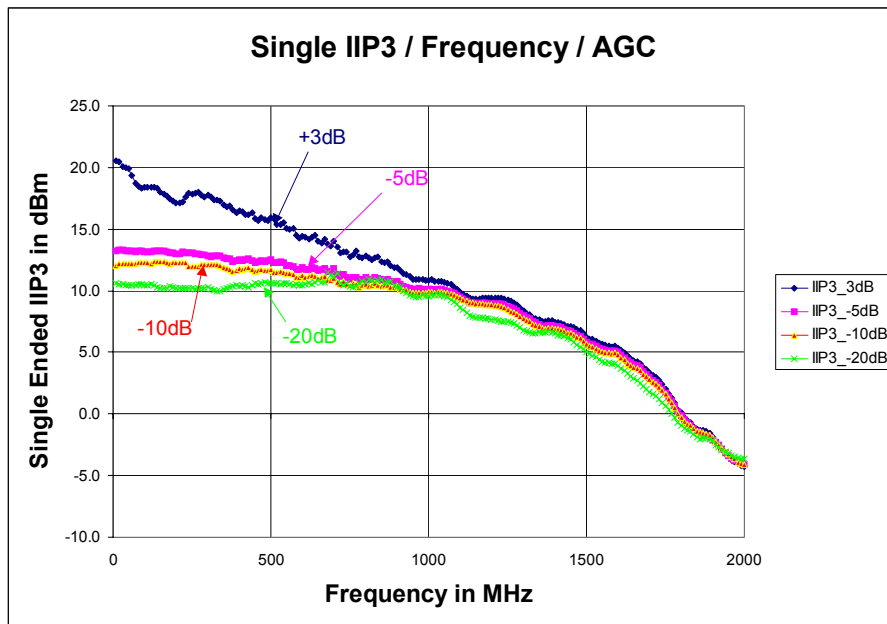

Figure 31 - Typical IIP3 Single Ended / Frequency / AGC

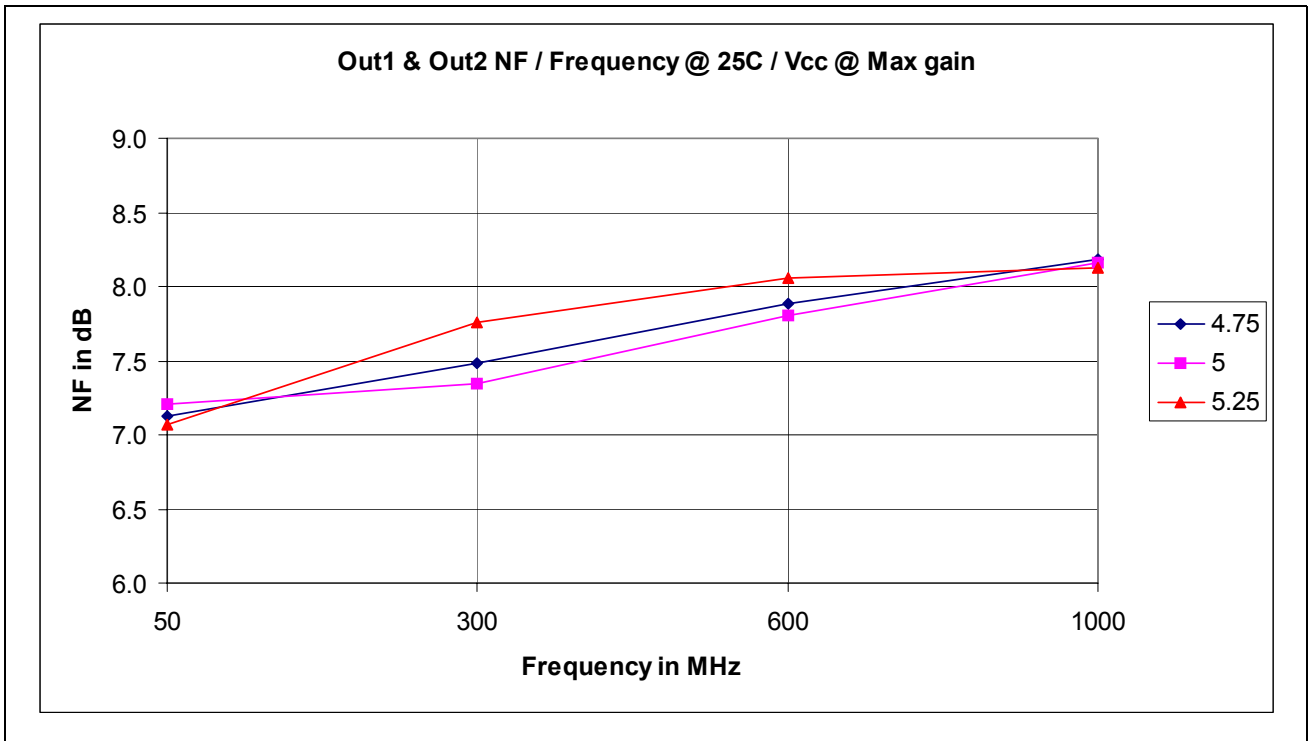

Figure 32 - Typical Differential NF / Frequency @ 25C / Vcc @ Max Gain

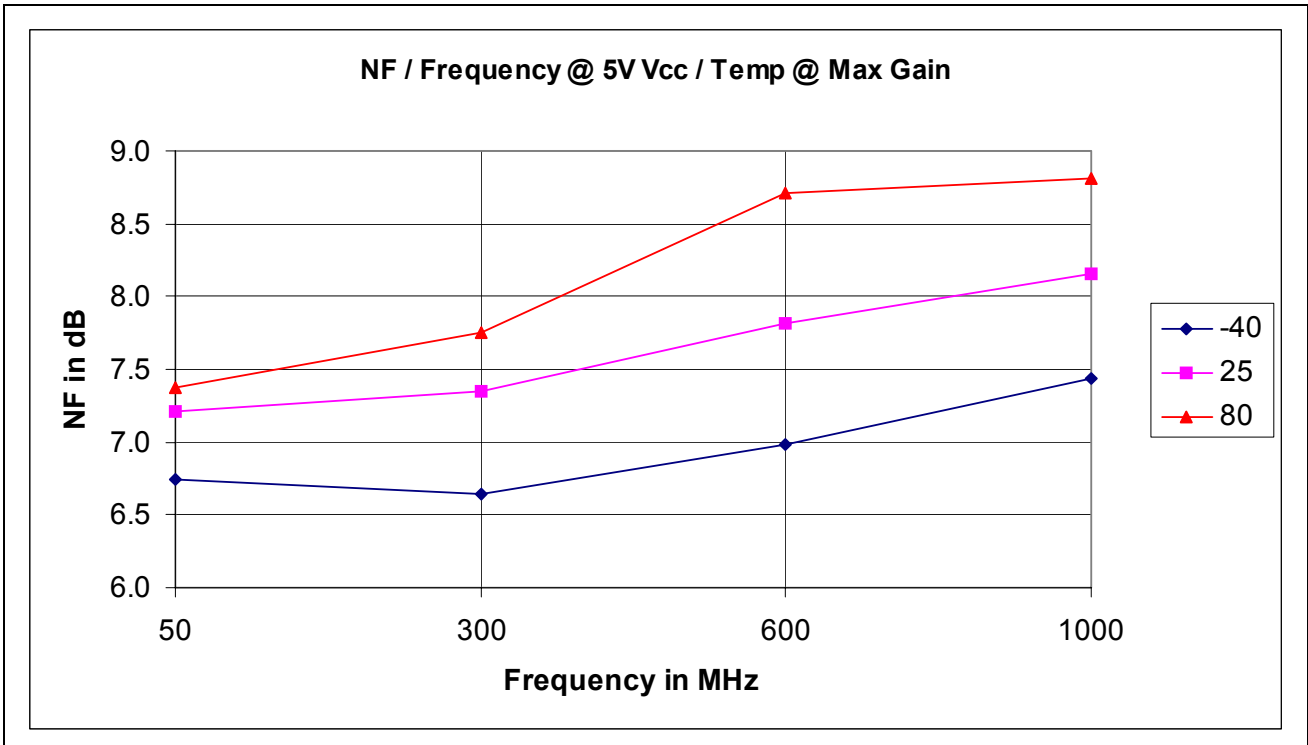

Figure 33 - Typical Differential NF / Frequency @ 5V Vcc / Temp @ Max Gain

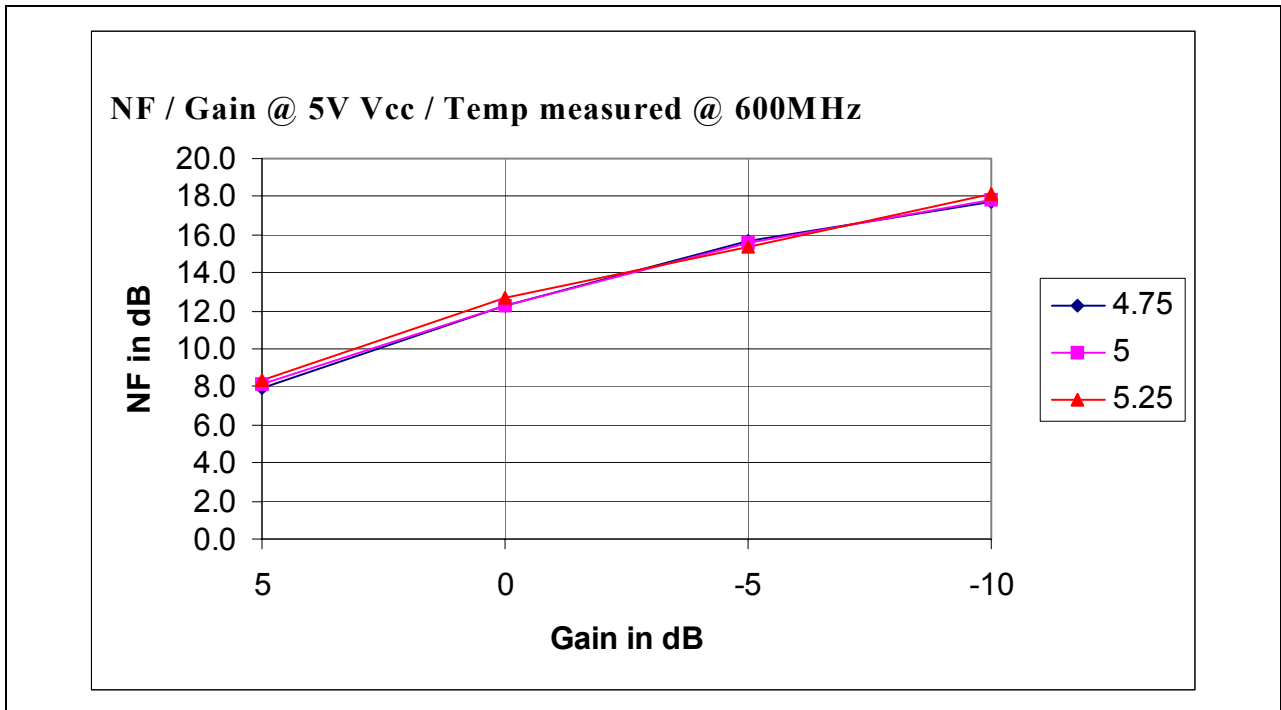

Figure 34 - Typical Differential NF / Gain @ 5V Vcc / Temp measured @ 600 MHz

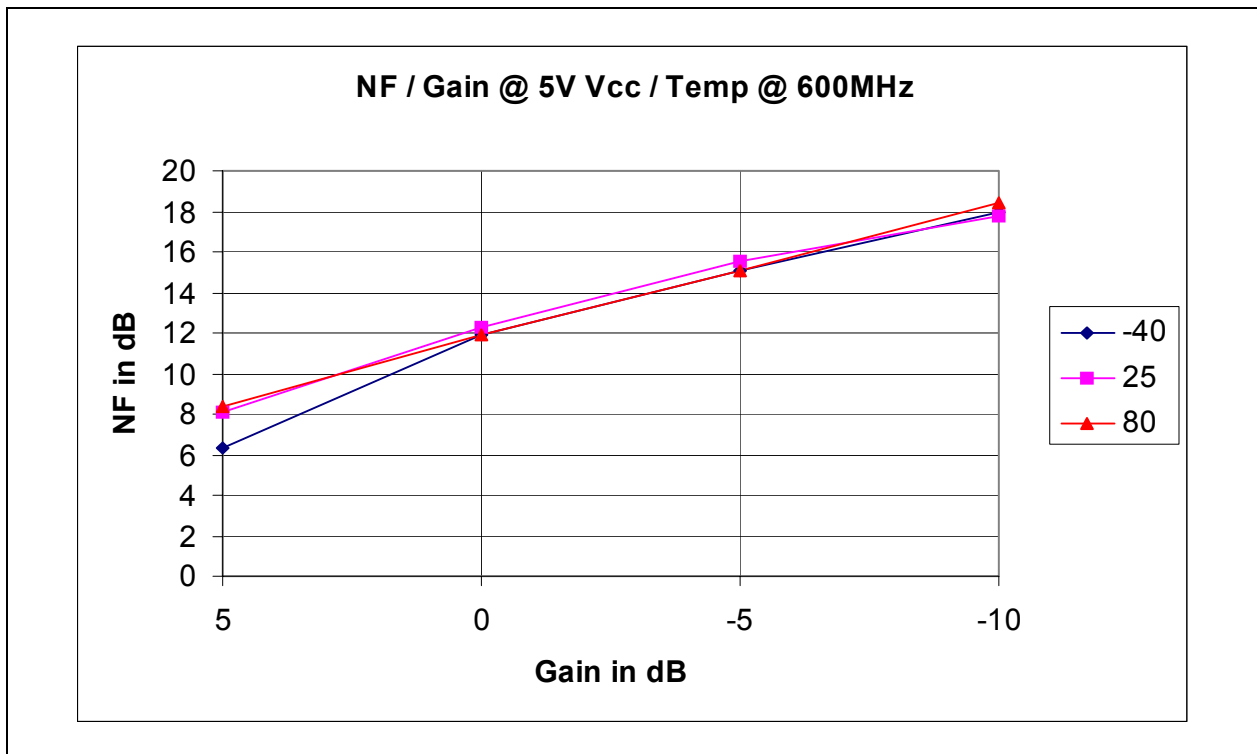

Figure 35 - Typical Differential NF / Gain @ 25C / Vcc measured @ 600 MHz

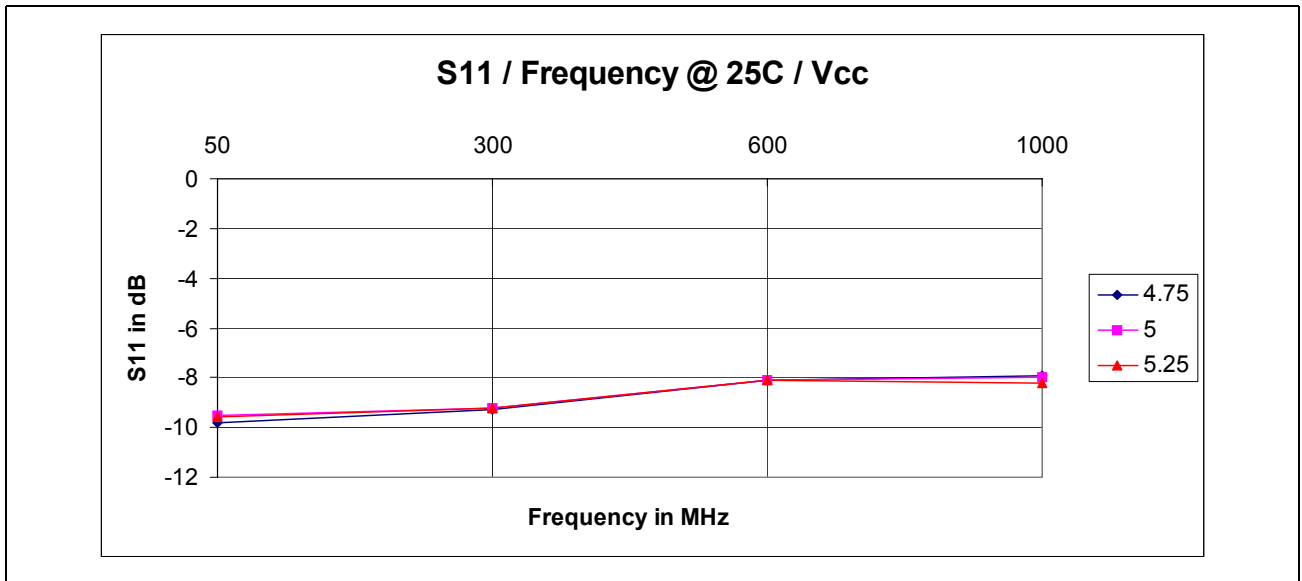

Figure 36 - Typical S11 in 50 Ohm System

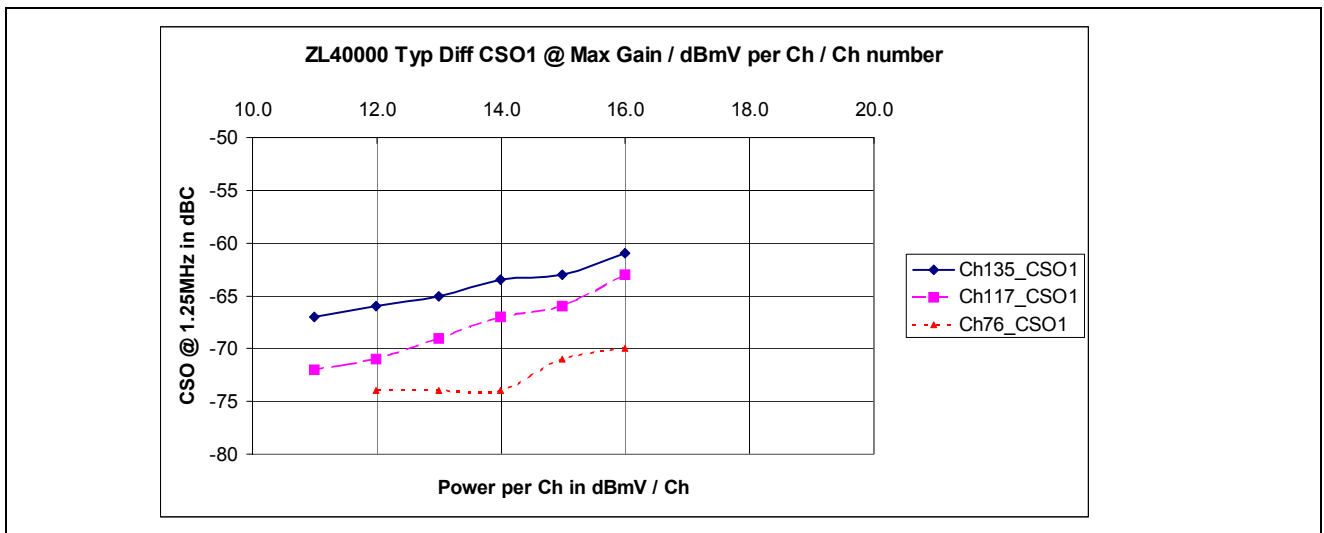

Figure 37 - Typical Differential CSO / Level per Channel @ Max Gain

CH136, CH117 and CH76 @ 850 MHz, 745 MHz and 499 MHz respectively) (Composite signal contains 130 Channels at 6 MHz spacing between 50 MHz and 850 MHz)

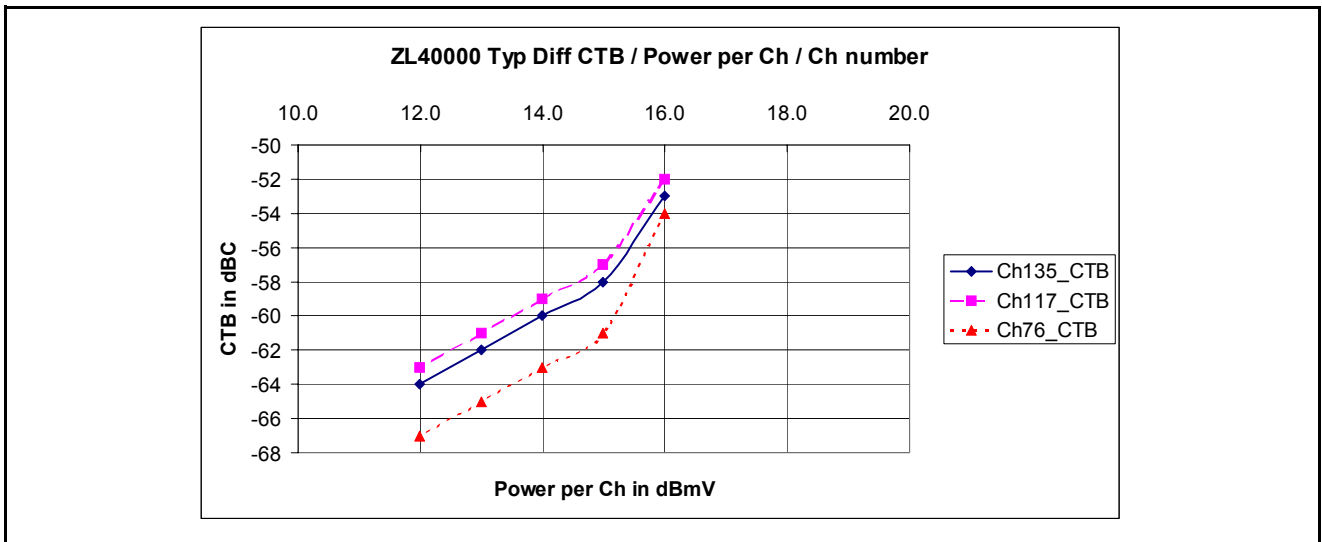

Figure 38 - Typical Differential CTB / Level per Channel @ Max Gain

(CH136, CH117 and CH76 @ 850 MHz, 745 MHz and 499 MHz respectively) (Composite signal contains 130 Channels at 6 MHz spacing between 50 MHz and 850 MHz)

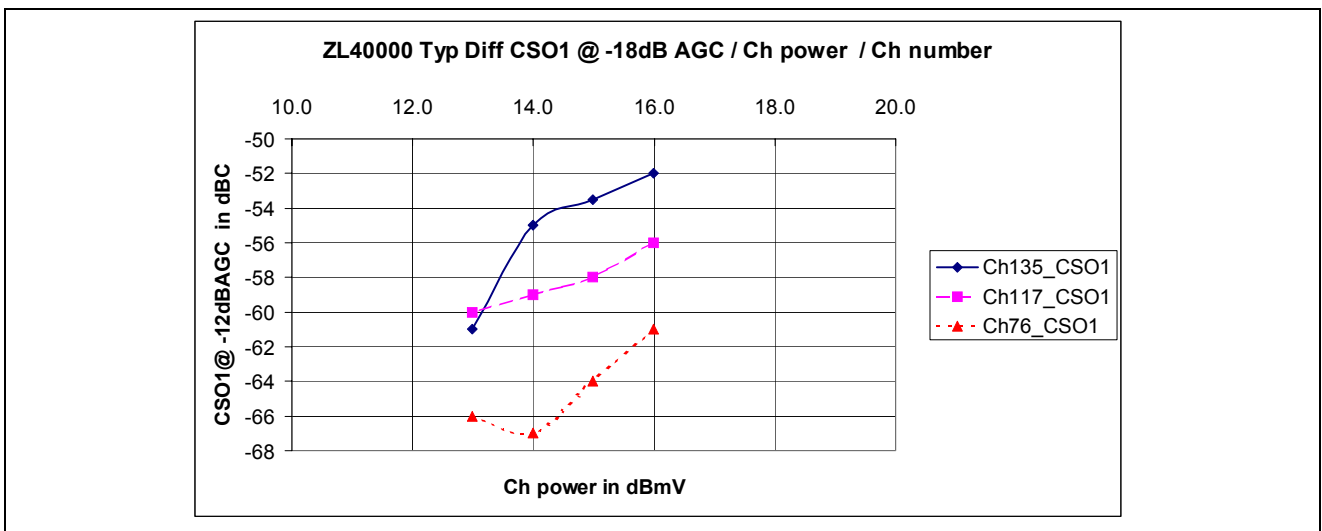

Figure 39 - Typical Differential CSO / Level per Channel @ -12dB Gain

(CH136, CH117 and CH76 @ 850 MHz, 745 MHz and 499 MHz respectively) (Composite signal contains 130 Channels at 6 MHz spacing between 50 MHz and 850 MHz)

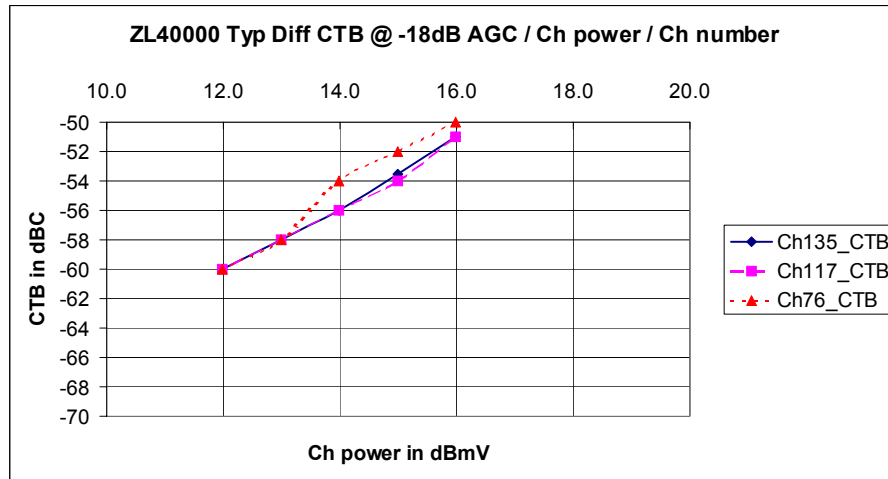

Figure 40 - CH136, CH117 and CH76 @ 850 MHz, 745 MHz and 499 MHz respectively

(Composite signal contains 130 Channels at 6 MHz spacing between 50 MHz and 850 MHz)

Applications Notes

The ZL40000 is a wide band RF signal conditioning and distribution circuit that can be used in many applications. The device has excellent signal handling performance and provides > 40 dB of AGC range over the full operating BW of DC to 2 GHz.

The device excellent dynamic performance and wide bandwidth make the device ideally suited to providing a separate buffered RF multi carrier signal to multiple tuner applications such as can be found in next generation Set Top Boxes, VCRs, DVDs and TVs for Digital Terrestrial, Cable and Satellite.

The device will also satisfy Analog Terrestrial, Cable and Satellite requirements up to -35 dBm / Ch in 130 Carrier Composite signals from 50 MHz to 850 MHz with 6 MHz channel spacing.

The very high signal handling RF AGC stage makes the ZL40000 suitable for use in all wide dynamic range receiver systems operating in the 1 MHz to 2 GHz band.

The ZL40000 has excellent RF AGC performance providing > 40 dB AGC range over the full DC to 2 GHz operating range. The RF AGC range exceeds 60 dBC from DC to 500 MHz.

Both the excellent RF AGC range and the excellent Multi Carrier performance are achieved as a result of the balanced nature of the circuit. The ZL40000 can be operated both single ended or differential at both the input and the output.

The performance achieved with the output signal used differential, increases the RF isolation and adds 20 dB improvement above that achieved single ended. It also greatly reduces the second order distortion and inter modulation present at the output.

The best performance is achieved when all output ports are connected to balanced loads and if a particular channel is to be used single ended output, the unused output should be terminated with a matching load.

The excellent RF range and high BW AGC control port makes the ZL40000 suitable for applications in which fast level control or RF Signal Switching is required such as may be found in Instrumentation.

The RF AGC attenuator can be switched through 60 dB of AGC range typically 15 nS.

A pair of ZL4000 with cross coupled outputs and a broad band quadrature phase shift unit can be used to build a broad band RF phase rotator that could be used in Agile Active Antenna Arrays for Transmitters with fast beam steering.

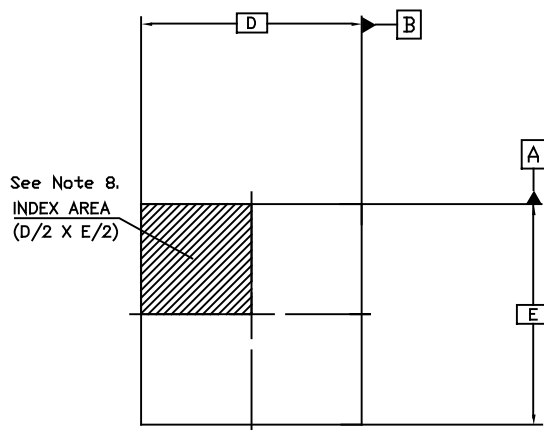

TOP VIEW

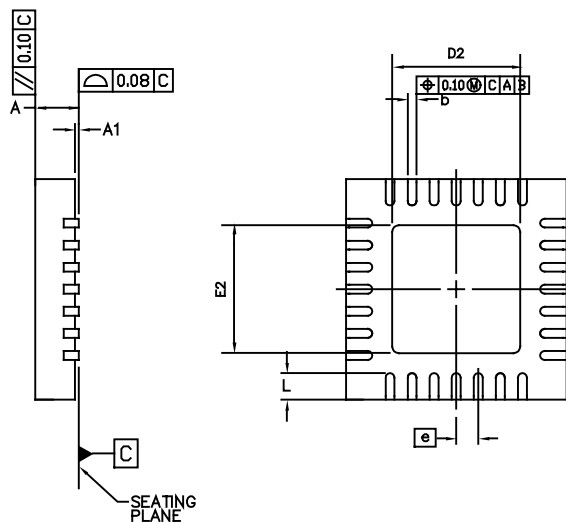

BOTTOM VIEW

| SYMBOL | COMMON DIMENSIONS | |
|--------|-------------------|-------|
| | MIN. | MAX. |
| A | — | 1.00 |
| A1 | 0.00 | 0.05 |
| b | 0.18 | 0.30 |
| D | 4.925 | 5.075 |
| D2 | 3.00 | 3.25 |
| E | 4.925 | 5.075 |
| E2 | 3.00 | 3.25 |
| N | 28 | |
| Nd | 7 | |
| Ne | 7 | |
| e | 0.50 BSC | |
| L | 0.35 | 0.75 |

Conforms to JEDEC MO-220 VHHD-1 iss A

- NOTES:
1. DIMENSIONING & TOLERANCES CONFORM TO ASME Y14.5M. – 1994.
 2. N IS THE NUMBER OF TERMINALS.
Nd & Ne ARE THE NUMBER OF TERMINALS ON EACH D AND E SIDE RESPECTIVELY
 3. DIMENSION b APPLIES TO PLATED TERMINAL AND IS MEASURED BETWEEN 0.25 AND 0.30mm FROM TERMINAL.
 4. ALL DIMENSIONS ARE IN MILLIMETERS.
 5. LEAD COUNT IS 28 .
 6. PACKAGE WARPAGE MAX 0.08mm.
 7. NOT TO SCALE.
 8. TERMINAL #1 IDENTIFIER MUST BE LOCATED WITHIN THE ZONE INDICATED AND MAY BE EITHER A MOULD OR MARKED FEATURE.

© Zarlink Semiconductor 2006. All rights reserved.

| ISSUE | 2 | 3 | 4 | 5 |
|--------|--------|---------|--------|---------|
| ACN | 212494 | 212973 | CDCA | CDCA |
| DATE | 8Apr02 | 21Jun02 | 6Jan05 | 23Jan06 |
| APPRD. | | | | |



Previous package codes
LH

Package Code **LC**

Package Outline for 28 Lead QFN (5 x 5mm)

GPD00747



**For more information about all Zarlink products
visit our Web Site at
www.zarlink.com**

Information relating to products and services furnished herein by Zarlink Semiconductor Inc. or its subsidiaries (collectively "Zarlink") is believed to be reliable. However, Zarlink assumes no liability for errors that may appear in this publication, or for liability otherwise arising from the application or use of any such information, product or service or for any infringement of patents or other intellectual property rights owned by third parties which may result from such application or use. Neither the supply of such information or purchase of product or service conveys any license, either express or implied, under patents or other intellectual property rights owned by Zarlink or licensed from third parties by Zarlink, whatsoever. Purchasers of products are also hereby notified that the use of product in certain ways or in combination with Zarlink, or non-Zarlink furnished goods or services may infringe patents or other intellectual property rights owned by Zarlink.

This publication is issued to provide information only and (unless agreed by Zarlink in writing) may not be used, applied or reproduced for any purpose nor form part of any order or contract nor to be regarded as a representation relating to the products or services concerned. The products, their specifications, services and other information appearing in this publication are subject to change by Zarlink without notice. No warranty or guarantee express or implied is made regarding the capability, performance or suitability of any product or service. Information concerning possible methods of use is provided as a guide only and does not constitute any guarantee that such methods of use will be satisfactory in a specific piece of equipment. It is the user's responsibility to fully determine the performance and suitability of any equipment using such information and to ensure that any publication or data used is up to date and has not been superseded. Manufacturing does not necessarily include testing of all functions or parameters. These products are not suitable for use in any medical products whose failure to perform may result in significant injury or death to the user. All products and materials are sold and services provided subject to Zarlink's conditions of sale which are available on request.

Purchase of Zarlink's I²C components conveys a licence under the Philips I²C Patent rights to use these components in and I²C System, provided that the system conforms to the I²C Standard Specification as defined by Philips.

Zarlink, ZL and the Zarlink Semiconductor logo are trademarks of Zarlink Semiconductor Inc.

Copyright Zarlink Semiconductor Inc. All Rights Reserved.

TECHNICAL DOCUMENTATION - NOT FOR RESALE
