

**1A ULTRA LOW DROPOUT LINEAR REGULATOR****AZ2940****General Description**

The AZ2940 is a low dropout three-terminal regulator with a typical dropout of 280mV at 1A output current.

The AZ2940 provides current limit and thermal shutdown. On-chip thermal shutdown provides protection against any combination of high current and ambient temperature that would create excessive junction temperatures.

The AZ2940 has 2.5V, 3.3V and 5.0V versions.

The AZ2940 is available in the industry standard TO-220-3, TO-263-3 and TO-252-2 power packages.

Features

- Minimum Guaranteed Output Current: 1A
- Dropout Voltage at $I_{OUT}=1A$: 280mV
- Output Accuracy: $\pm 1\%$
- Low Ground Current
- Internal Current Limit and Thermal Protection
- Reversed-battery and Reversed-lead Insertion Protection
- Fast Transient Response

Applications

- LCD TV
- Set Top Box
- LCD Monitor
- SMPS Post Regulator
- Laptop, Palmtop and Notebook
- Portable Instrumentation
- USB Power Supply

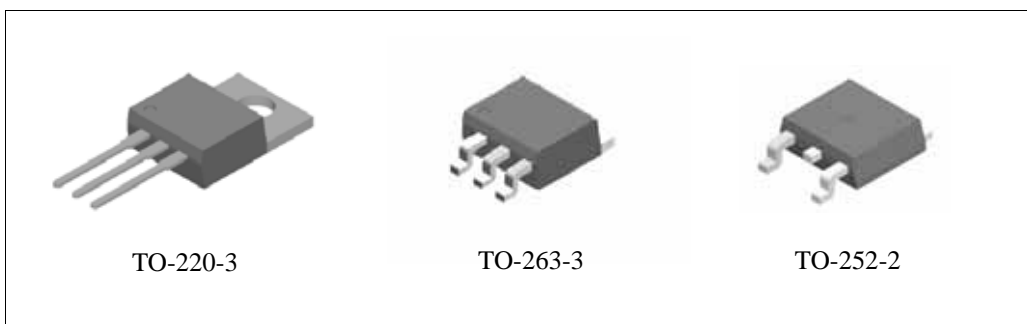

Figure 1. Package Types of AZ2940

**1A ULTRA LOW DROPOUT LINEAR REGULATOR****AZ2940****Pin Configuration**

Figure 2. Pin Configuration of AZ2940 (Top View)

Pin Description

Pin Number	Pin Name	Function
1	V_{IN}	Unregulated Input.
2	GND	Ground pin. This pin and TAB are internally connected.
3	V_{OUT}	Regulated Output.

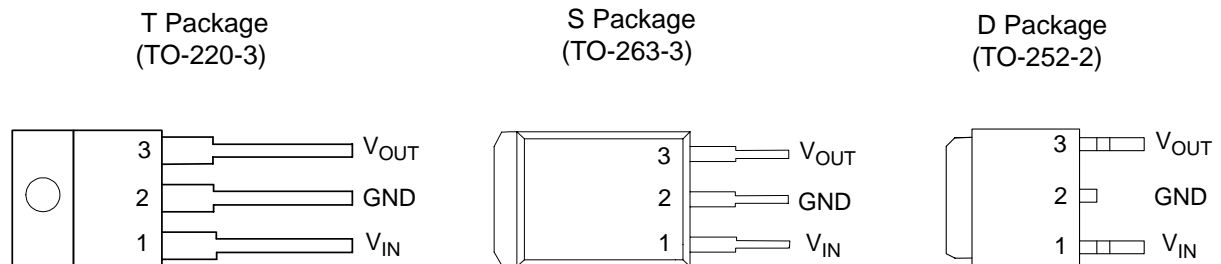

1A ULTRA LOW DROPOUT LINEAR REGULATOR

AZ2940

Functional Block Diagram

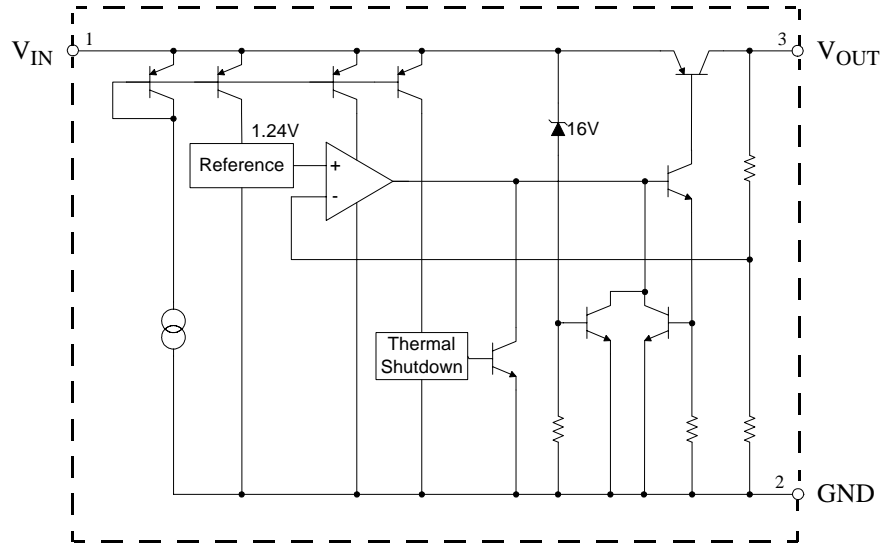
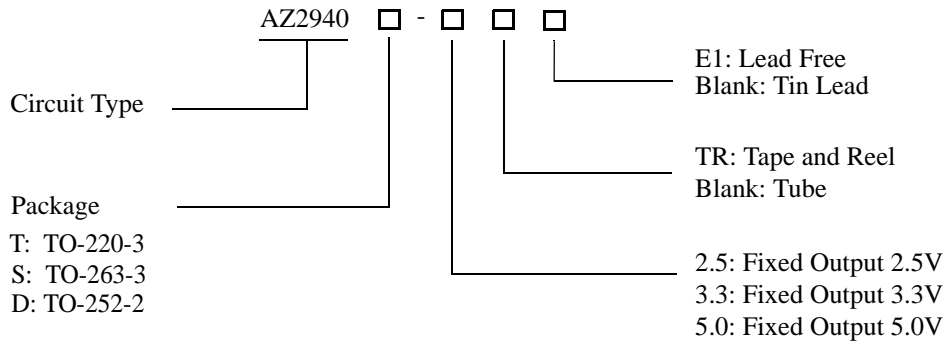

Figure 3. Functional Block Diagram of AZ2940



1A ULTRA LOW DROPOUT LINEAR REGULATOR **AZ2940**

Ordering Information



Package	Temperature Range	Part Number		Marking ID		Packing Type
		Tin Lead	Lead Free	Tin Lead	Lead Free	
TO-220-3	-40 to 125°C	AZ2940T-2.5	AZ2940T-2.5E1	AZ2940T-2.5	AZ2940T-2.5E1	Tube
		AZ2940T-3.3	AZ2940T-3.3E1	AZ2940T-3.3	AZ2940T-3.3E1	Tube
		AZ2940T-5.0	AZ2940T-5.0E1	AZ2940T-5.0	AZ2940T-5.0E1	Tube
TO-263-3	-40 to 125°C	AZ2940S-2.5	AZ2940S-2.5E1	AZ2940S-2.5	AZ2940S-2.5E1	Tube
		AZ2940S-2.5TR	AZ2940S-2.5TRE1	AZ2940S-2.5	AZ2940S-2.5E1	Tape & Reel
		AZ2940S-3.3	AZ2940S-3.3E1	AZ2940S-3.3	AZ2940S-3.3E1	Tube
		AZ2940S-3.3TR	AZ2940S-3.3TRE1	AZ2940S-3.3	AZ2940S-3.3E1	Tape & Reel
		AZ2940S-5.0	AZ2940S-5.0E1	AZ2940S-5.0	AZ2940S-5.0E1	Tube
		AZ2940S-5.0TR	AZ2940S-5.0TRE1	AZ2940S-5.0	AZ2940S-5.0E1	Tape & Reel
TO-252-2	-40 to 125°C	AZ2940D-2.5	AZ2940D-2.5E1	AZ2940D-2.5	AZ2940D-2.5E1	Tube
		AZ2940D-2.5TR	AZ2940D-2.5TRE1	AZ2940D-2.5	AZ2940D-2.5E1	Tape & Reel
		AZ2940D-3.3	AZ2940D-3.3E1	AZ2940D-3.3	AZ2940D-3.3E1	Tube
		AZ2940D-3.3TR	AZ2940D-3.3TRE1	AZ2940D-3.3	AZ2940D-3.3E1	Tape & Reel
		AZ2940D-5.0	AZ2940D-5.0E1	AZ2940D-5.0	AZ2940D-5.0E1	Tube
		AZ2940D-5.0TR	AZ2940D-5.0TRE1	AZ2940D-5.0	AZ2940D-5.0E1	Tape & Reel

BCD Semiconductor's Pb-free products, as designated with "E1" suffix in the part number, are RoHS compliant.

**1A ULTRA LOW DROPOUT LINEAR REGULATOR****AZ2940****Absolute Maximum Ratings (Note 1)**

Parameter	Symbol	Value	Unit
Supply Voltage	V_{IN}	16	V
Maximum Operating Junction Temperature	T_J	150	°C
Storage Temperature Range	T_{STG}	-65 to 150	°C
Lead Temperature (Soldering, 10sec)	T_{LEAD}	300	°C
ESD (Machine Model)		300	V

Note 1: Stresses greater than those listed under "Absolute Maximum Ratings" may cause permanent damage to the device. These are stress ratings only, and functional operation of the device at these or any other conditions beyond those indicated under "Recommended Operating Conditions" is not implied. Exposure to "Absolute Maximum Ratings" for extended periods may affect device reliability.

Recommended Operating Conditions

Parameter	Symbol	Min	Max	Unit
Supply Voltage	V_{IN}		13.2	V
Operating Junction Temperature	T_J	-40	125	°C



1A ULTRA LOW DROPOUT LINEAR REGULATOR

AZ2940

Electrical Characteristics

AZ2940-2.5V Electrical Characteristics

Operating Conditions: $V_{IN}=3.5V$, $I_{OUT}=10mA$, $C_{IN}=10\mu F$, $C_{OUT}=10\mu F$, $T_J=25^{\circ}C$, unless otherwise specified.

The **Boldface** applies over $-40^{\circ}C \leq T_J \leq 125^{\circ}C$.

Parameter	Symbol	Condition	Min	Typ	Max	Unit	
Output Voltage	V_{OUT}	$I_{OUT}=10mA$	2.475	2.5	2.525	V	
		$10mA \leq I_{OUT} \leq 1A$, $3.5V \leq V_{IN} \leq 13.2V$	2.45	2.5	2.55	V	
Line Regulation	V_{RLINE}	$I_{OUT}=10mA$, $3.5V \leq V_{IN} \leq 13.2V$		5.0	25	mV	
Load Regulation	V_{RLOAD}	$V_{IN}=3.5V$, $10mA \leq I_{OUT} \leq 1A$		7.5	37.5	mV	
Output Voltage Temperature Coefficient	$\Delta V_{OUT}/\Delta T$	$I_{OUT}=10mA$		50	250	$\mu V/^{\circ}C$	
Dropout Voltage (Note 2)	V_{DROP}	$\Delta V_{OUT}=1\%$	$I_{OUT}=100mA$		70	200	mV
			$I_{OUT}=1A$		280	550	mV
Ground Current	I_{GND}	$V_{IN}=3.5V$	$I_{OUT}=750mA$		12	25	mA
			$I_{OUT}=1A$		18		mA
Current Limit	I_{LIMIT}	$V_{OUT}=0V$ (Note 3)	1.5	2.2		A	
Minimum Load Current	$I_{LOAD (MIN)}$			1	5	mA	
Output Noise Voltage (rms)		10Hz to 100KHz, $I_{OUT}=100mA$, $C_{OUT}=10\mu F$		400		μV	

Note 2: Dropout voltage is defined as the input-to-output differential when the output voltage drops to 99% of its nominal value which is measured at $V_{OUT}+1V$ applied to V_{IN} .

Note 3: $V_{IN}=V_{OUT(NOMINAL)}+1V$.



1A ULTRA LOW DROPOUT LINEAR REGULATOR **AZ2940**

Electrical Characteristics (Continued)

AZ2940-3.3V Electrical Characteristics

Operating Conditions: $V_{IN}=4.3V$, $I_{OUT}=10mA$, $C_{IN}=10\mu F$, $C_{OUT}=10\mu F$, $T_J=25^\circ C$, unless otherwise specified. The **Boldface** applies over $-40^\circ C \leq T_J \leq 125^\circ C$.

Parameter	Symbol	Condition	Min	Typ	Max	Unit	
Output Voltage	V_{OUT}	$I_{OUT}=10mA$	3.27	3.3	3.33	V	
		$10mA \leq I_{OUT} \leq 1A$, $4.3V \leq V_{IN} \leq 13.2V$	3.23	3.3	3.37	V	
Line Regulation	V_{RLINE}	$I_{OUT}=10mA$, $4.3V \leq V_{IN} \leq 13.2V$		6.6	33	mV	
Load Regulation	V_{RLOAD}	$V_{IN}=4.3V$, $10mA \leq I_{OUT} \leq 1A$		9.9	50	mV	
Output Voltage Temperature Coefficient	$\Delta V_{OUT}/\Delta T$	$I_{OUT}=10mA$		66	330	$\mu V/^\circ C$	
Dropout Voltage (Note 2)	V_{DROP}	$\Delta V_{OUT}=1\%$	$I_{OUT}=100mA$		70	200	mV
			$I_{OUT}=1A$		280	550	mV
Ground Current	I_{GND}	$V_{IN}=4.3V$	$I_{OUT}=750mA$		12	25	mA
			$I_{OUT}=1A$		18		mA
Current Limit	I_{LIMIT}	$V_{OUT}=0V$ (Note 3)	1.5	2.2		A	
Minimum Load Current	$I_{LOAD(MIN)}$			1	5	mA	
Output Noise Voltage (rms)		10Hz to 100KHz, $I_{OUT}=100mA$, $C_{OUT}=10\mu F$		400		μV	

Note 2: Dropout voltage is defined as the input-to-output differential when the output voltage drops to 99% of its nominal value which is measured at $V_{OUT}+1V$ applied to V_{IN} .

Note 3: $V_{IN}=V_{OUT(NOMINAL)}+1V$.



1A ULTRA LOW DROPOUT LINEAR REGULATOR AZ2940

Electrical Characteristics (Continued)

AZ2940-5.0V Electrical Characteristics

Operating Conditions: $V_{IN}=6V$, $I_{OUT}=10mA$, $C_{IN}=10\mu F$, $C_{OUT}=10\mu F$, $T_J=25^\circ C$, unless otherwise specified. The **Boldface** applies over $-40^\circ C \leq T_J \leq 125^\circ C$.

Parameter	Symbol	Condition	Min	Typ	Max	Unit	
Output Voltage	V_{OUT}	$I_{OUT}=10mA$	4.95	5.0	5.05	V	
		$10mA \leq I_{OUT} \leq 1A$, $6V \leq V_{IN} \leq 13.2V$	4.90	5.0	5.10	V	
Line Regulation	V_{RLINE}	$I_{OUT}=10mA$, $6V \leq V_{IN} \leq 13.2V$		10	50	mV	
Load Regulation	V_{RLOAD}	$V_{IN}=6V$, $10mA \leq I_{OUT} \leq 1A$		15	75	mV	
Output Voltage Temperature Coefficient	$\Delta V_{OUT}/\Delta T$	$I_{OUT}=10mA$		100	500	$\mu V/^\circ C$	
Dropout Voltage (Note 2)	V_{DROP}	$\Delta V_{OUT}=1\%$	$I_{OUT}=100mA$		70	200	mV
			$I_{OUT}=1A$		280	550	mV
Ground Current	I_{GND}	$V_{IN}=6V$	$I_{OUT}=750mA$		12	25	mA
			$I_{OUT}=1A$		18		mA
Current Limit	I_{LIMIT}	$V_{OUT}=0V$ (Note 3)	1.5	2.2		A	
Minimum Load Current	$I_{LOAD(MIN)}$			1	5	mA	
Output Noise Voltage (rms)		10Hz to 100KHz, $I_{OUT}=100mA$, $C_{OUT}=10\mu F$		400		μV	

Note 2: Dropout voltage is defined as the input-to-output differential when the output voltage drops to 99% of its nominal value which is measured at $V_{OUT}+1V$ applied to V_{IN} .

Note 3: $V_{IN}=V_{OUT(NOMINAL)}+1V$.



1A ULTRA LOW DROPOUT LINEAR REGULATOR

AZ2940

Typical Performance Characteristics

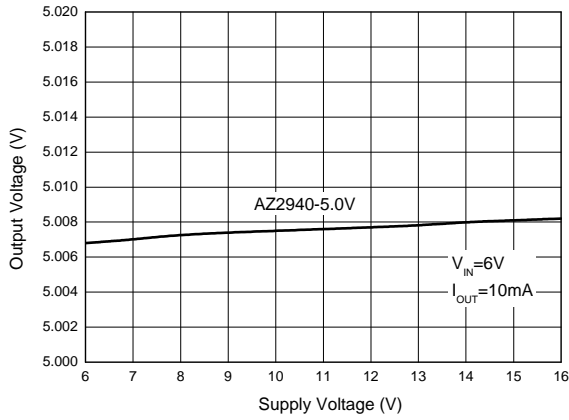

Figure 4. Line Regulation

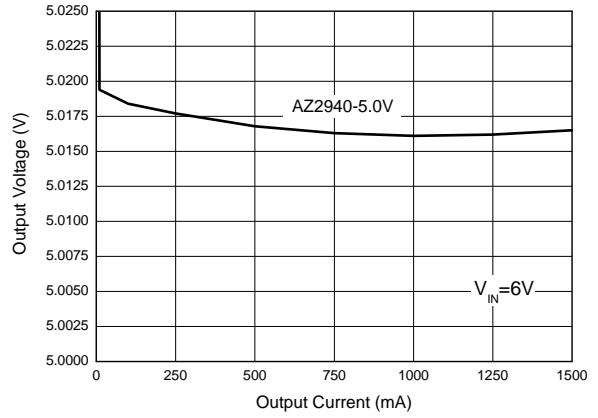

Figure 5. Load Regulation

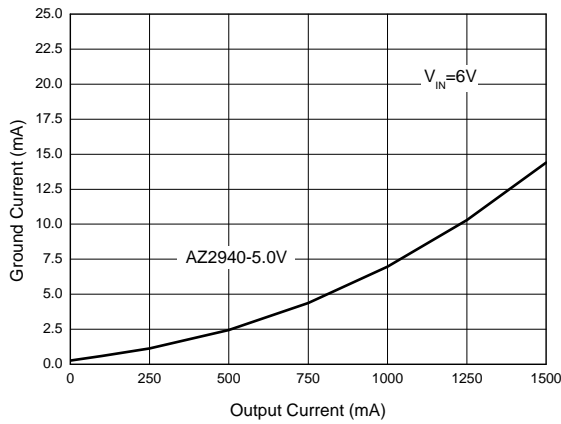

Figure 6. Ground Current vs. Output Current

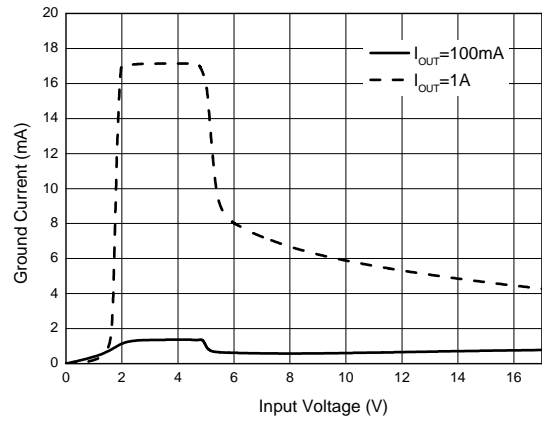

Figure 7. Ground Current vs. Input Voltage



1A ULTRA LOW DROPOUT LINEAR REGULATOR

AZ2940

Typical Performance Characteristics (Continued)

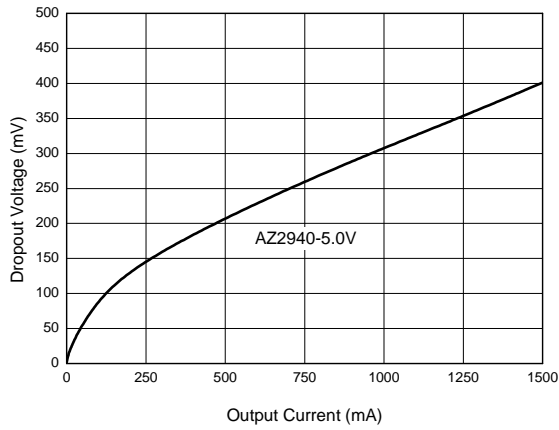

Figure 8. Dropout Voltage vs. Output Current

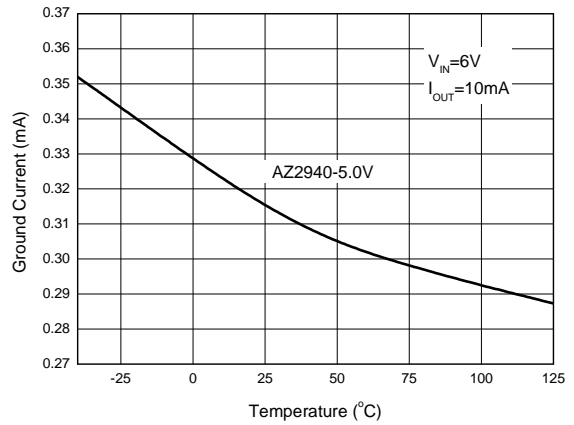

Figure 9. Ground Current vs. Temperature

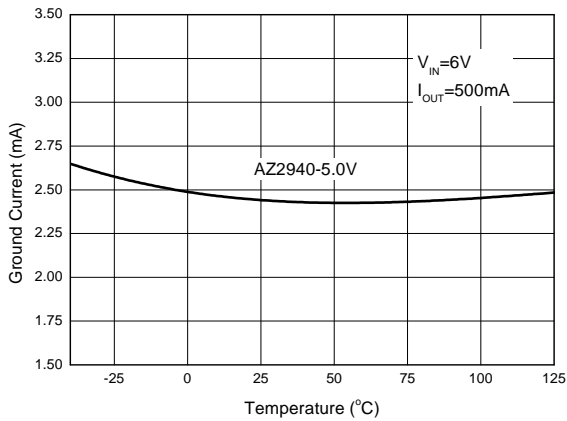

Figure 10. Ground Current vs. Temperature

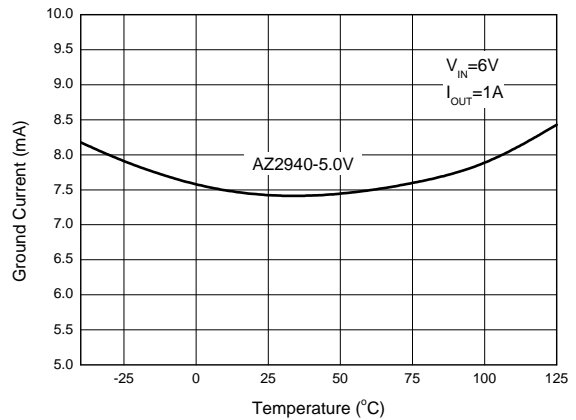

Figure 11. Ground Current vs. Temperature



1A ULTRA LOW DROPOUT LINEAR REGULATOR

AZ2940

Typical Performance Characteristics (Continued)

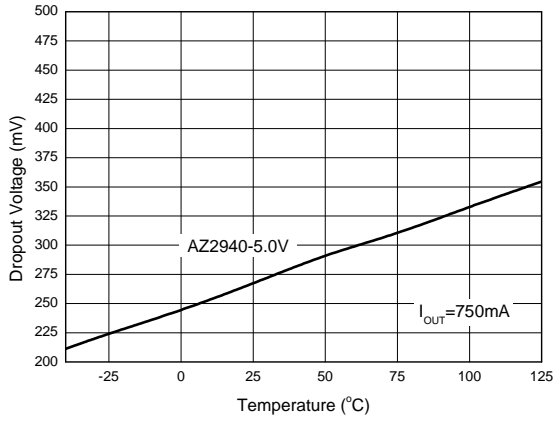

Figure 12. Dropout Voltage vs. Temperature

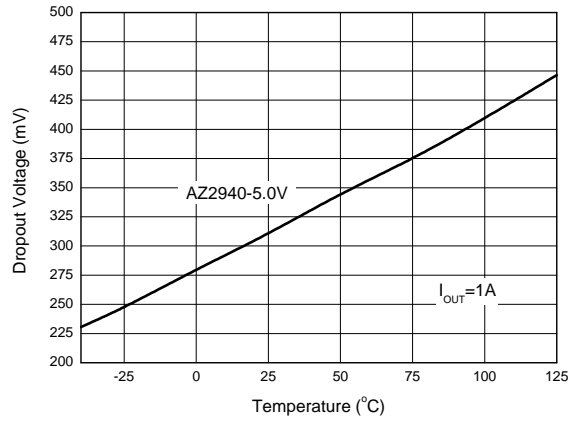

Figure 13. Dropout Voltage vs. Temperature

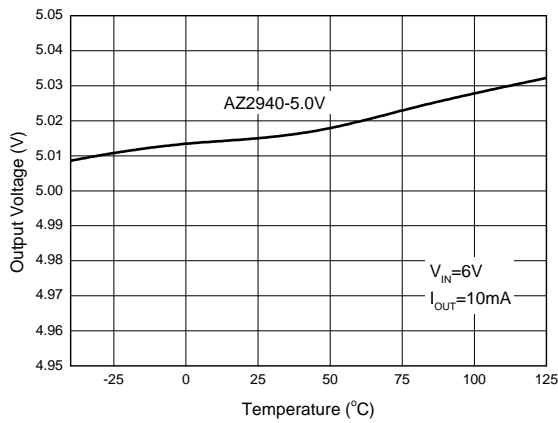

Figure 14. Output Voltage vs. Temperature

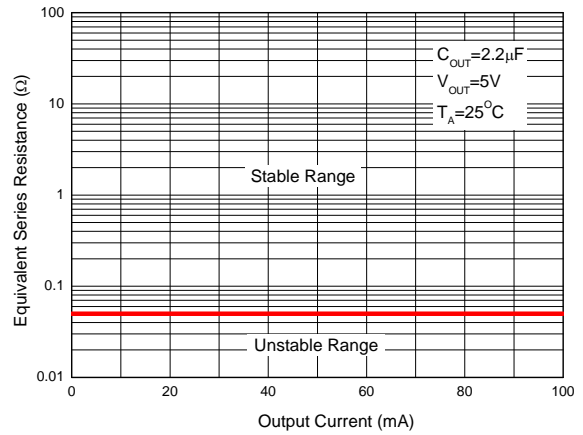

Figure 15. Output Capacitor ESR



1A ULTRA LOW DROPOUT LINEAR REGULATOR

AZ2940

Typical Performance Characteristics (Continued)

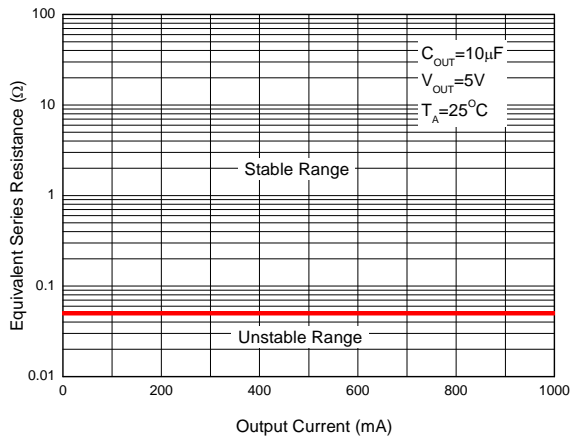

Figure 16. Output Capacitor ESR

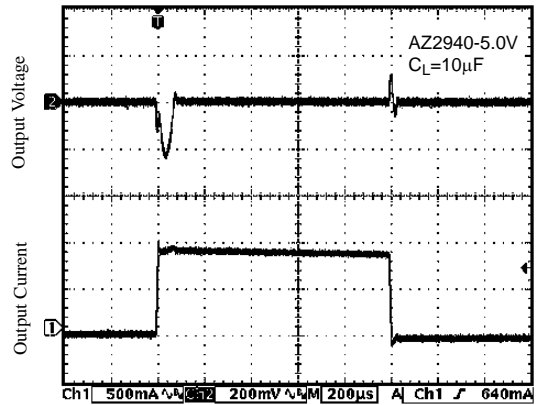

Figure 17. Load Transient

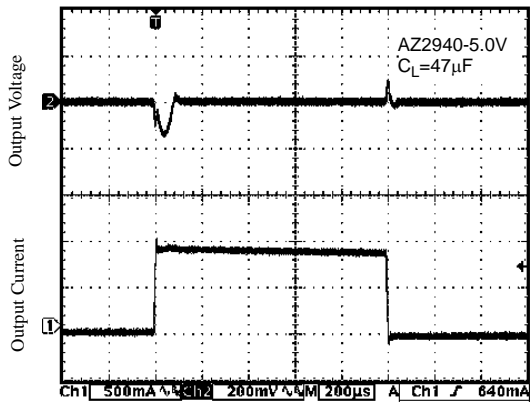

Figure 18. Load Transient

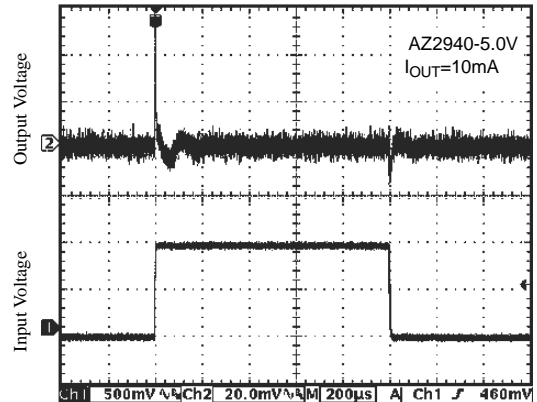

Figure 19. Line Transient



1A ULTRA LOW DROPOUT LINEAR REGULATOR

AZ2940

Typical Performance Characteristics (Continued)

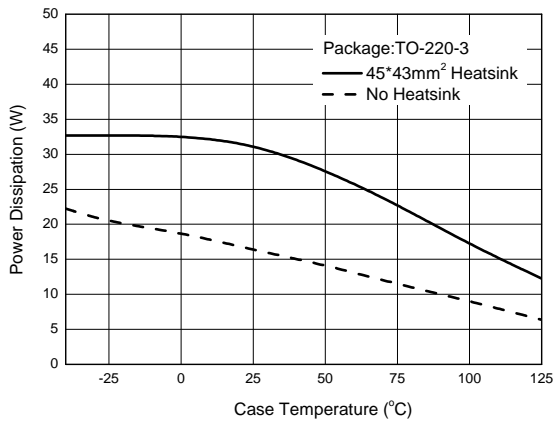

Figure 20. Power Dissipation vs. Case Temperature

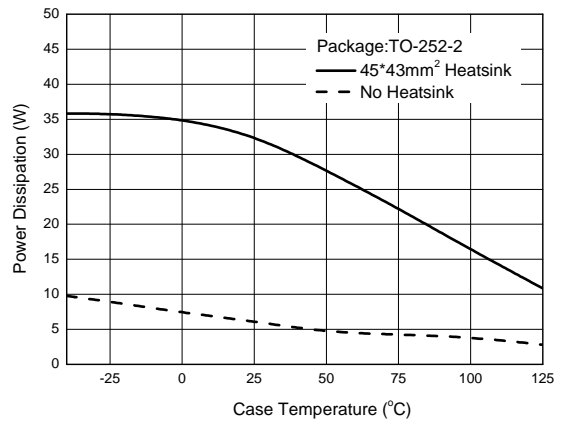

Figure 21. Power Dissipation vs. Case Temperature

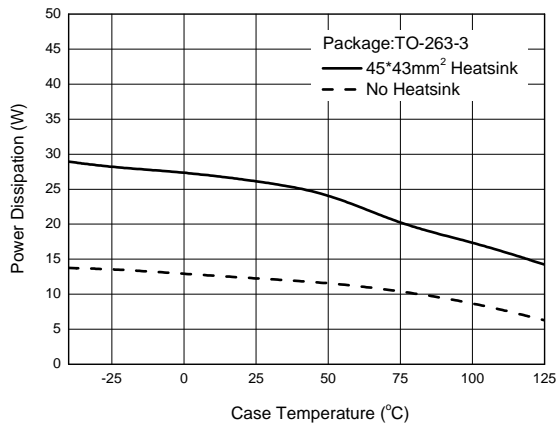

Figure 22. Power Dissipation vs. Case Temperature



1A ULTRA LOW DROPOUT LINEAR REGULATOR

AZ2940

Typical Application

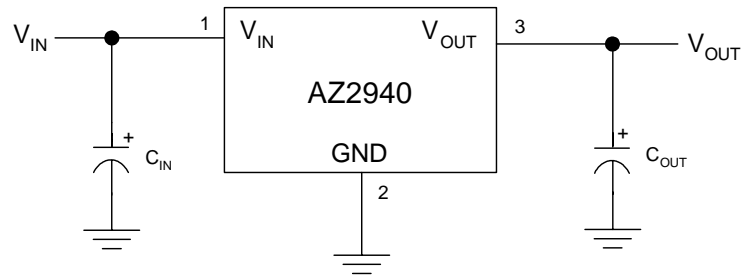

Figure 23. Typical Application of AZ2940

Note: C_{IN} is required if regulator is located far from power supply filter and is recommended to be $0.47\mu\text{F}$ or greater. To maintain stability, C_{OUT} is recommended to be $2.2\mu\text{F}$ or greater. The ESR of this capacitor is critical, please see curve.



1A ULTRA LOW DROPOUT LINEAR REGULATOR

AZ2940

Mechanical Dimensions

TO-220-3

Unit: mm(inch)

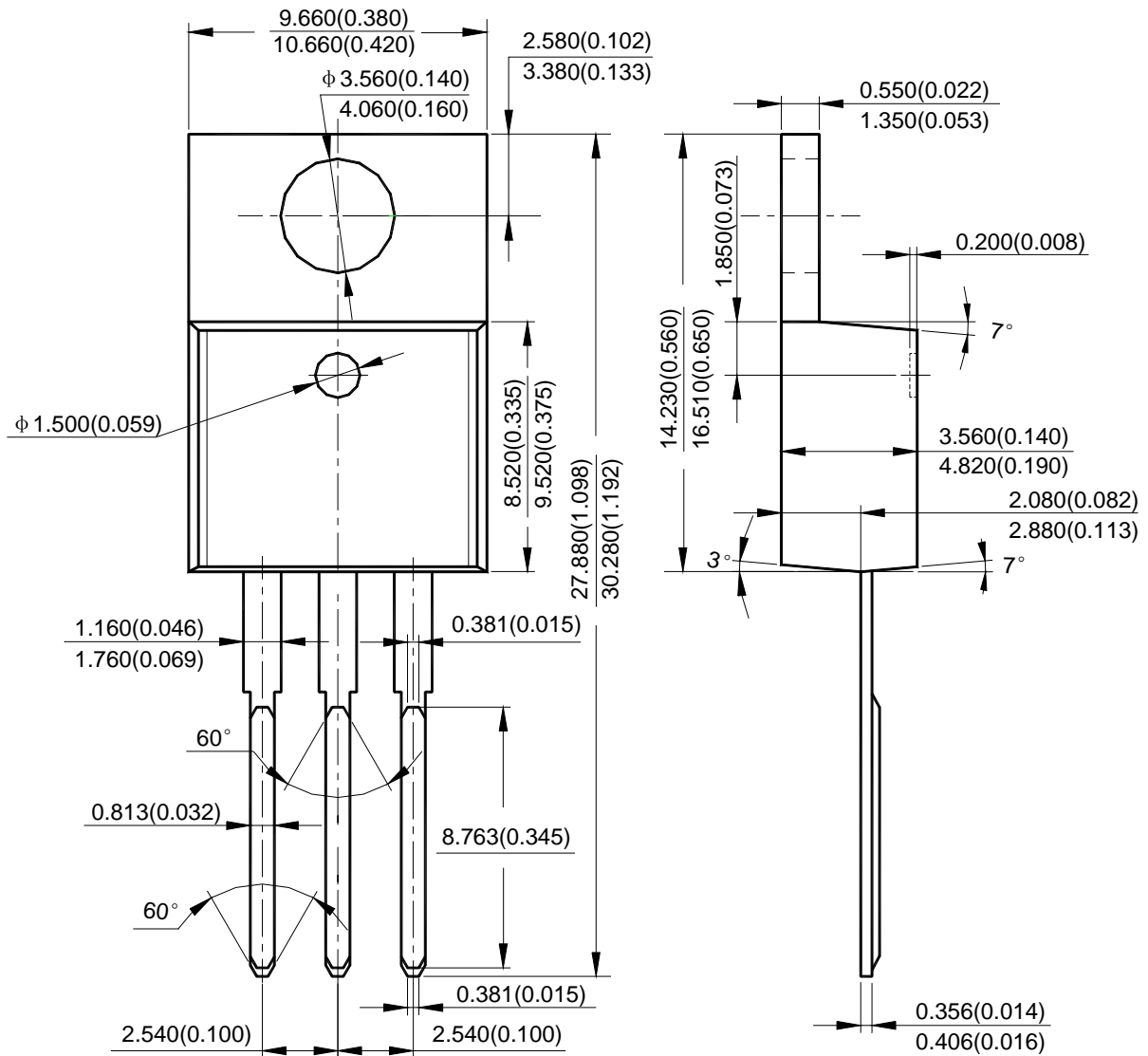



1A ULTRA LOW DROPOUT LINEAR REGULATOR

AZ2940

Mechanical Dimensions (Continued)

TO-263-3

Unit: mm(inch)

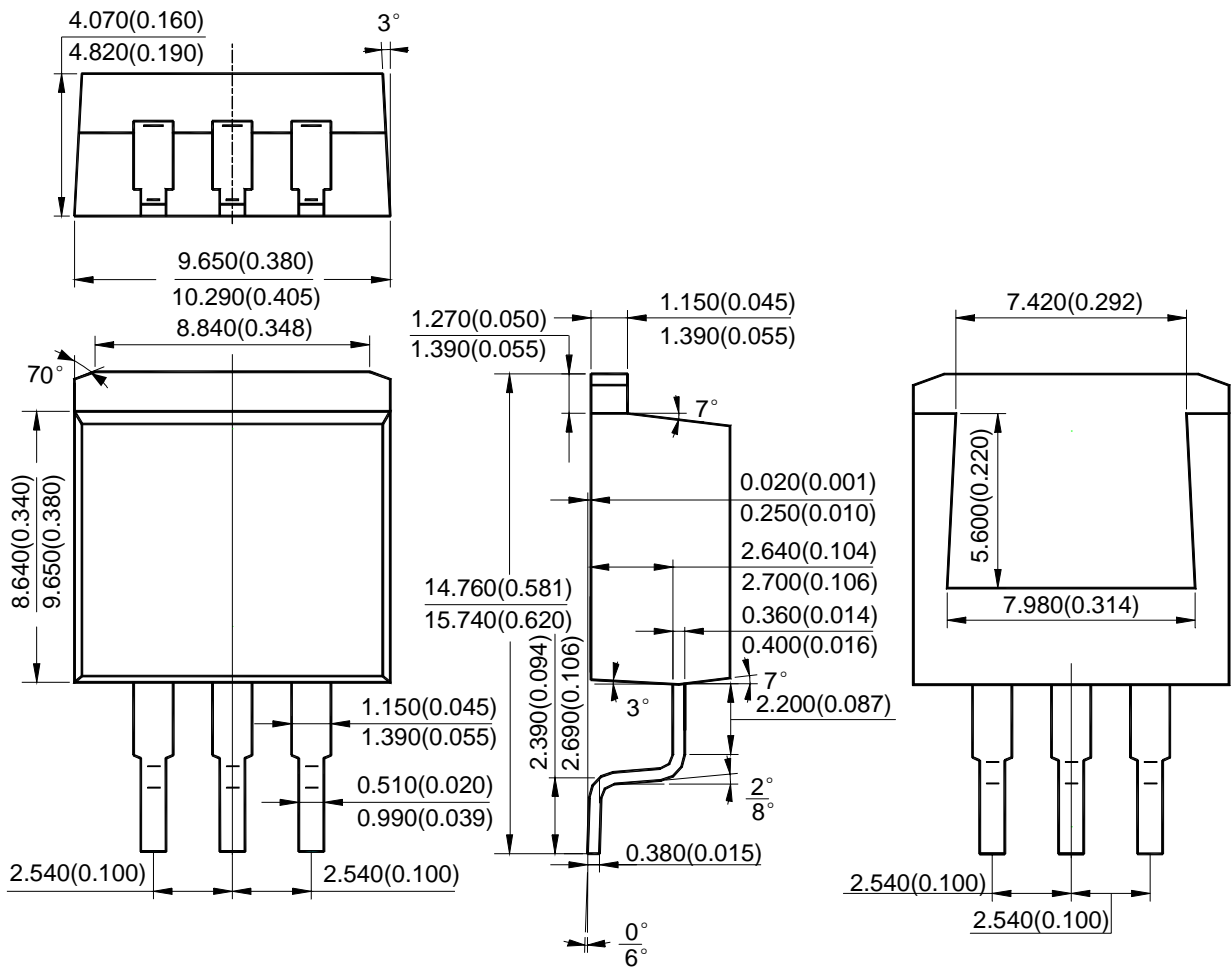



1A ULTRA LOW DROPOUT LINEAR REGULATOR **AZ2940**

Mechanical Dimensions (Continued)

TO-252-2

Unit: mm(inch)

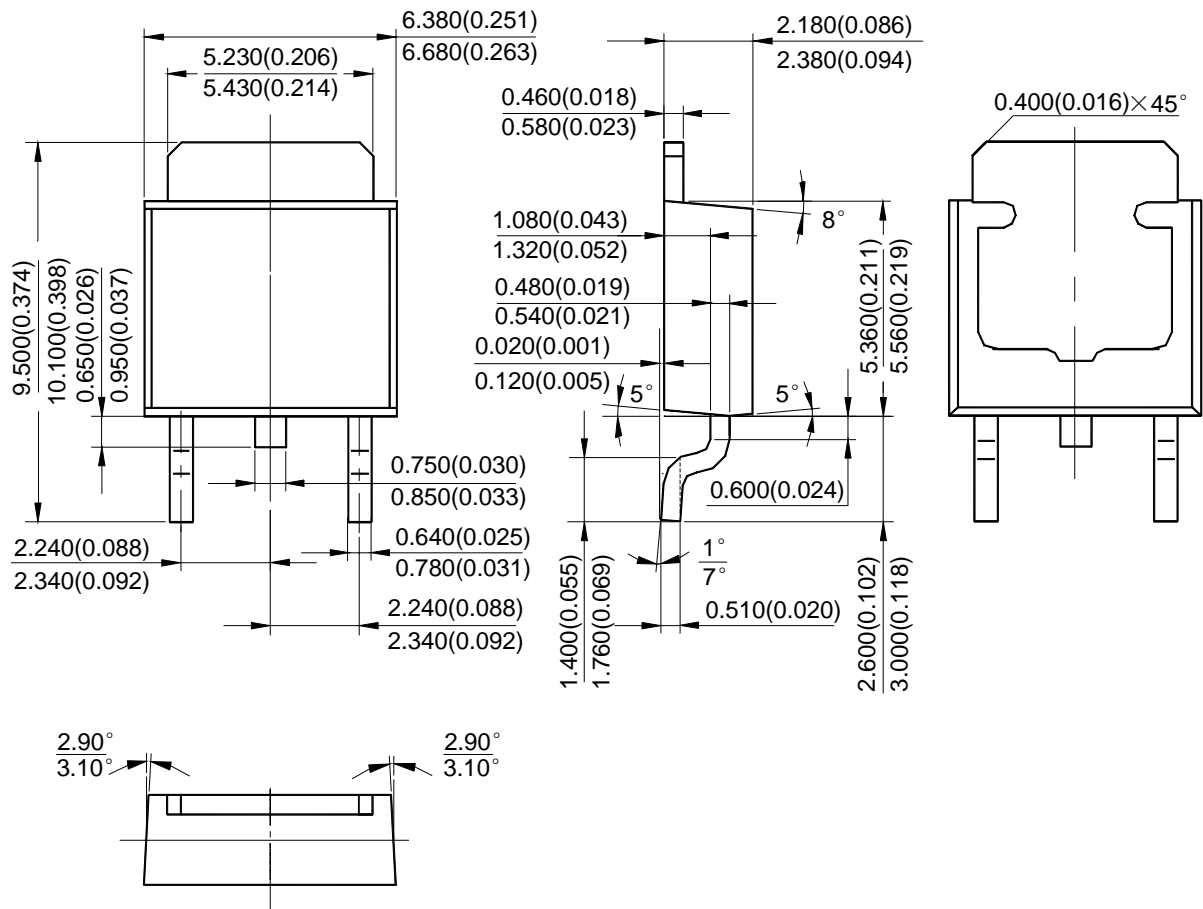



BCD Semiconductor Manufacturing Limited

<http://www.bcdsemi.com>

IMPORTANT NOTICE

BCD Semiconductor Manufacturing Limited reserves the right to make changes without further notice to any products or specifications herein. BCD Semiconductor Manufacturing Limited does not assume any responsibility for use of any its products for any particular purpose, nor does BCD Semiconductor Manufacturing Limited assume any liability arising out of the application or use of any its products or circuits. BCD Semiconductor Manufacturing Limited does not convey any license under its patent rights or other rights nor the rights of others.

MAIN SITE

BCD Semiconductor Manufacturing Limited
- Wafer Fab
Shanghai SIM-BCD Semiconductor Manufacturing Limited
800, Yi Shan Road, Shanghai 200233, China
Tel: +86-21-6485 1491, Fax: +86-21-5450 0008

BCD Semiconductor Manufacturing Limited
- IC Design Group
Advanced Analog Circuits (Shanghai) Corporation
8F, Zone B, 900, Yi Shan Road, Shanghai 200233, China
Tel: +86-21-6495 9539, Fax: +86-21-6485 9673

REGIONAL SALES OFFICE

Shenzhen Office
Shanghai SIM-BCD Semiconductor Manufacturing Co., Ltd. Shenzhen Office
Advanced Analog Circuits (Shanghai) Corporation Shenzhen Office
27B, Tower C, 2070, Middle Shen Nan Road, Shenzhen 518031, China
Tel: +86-755-8368 3987, Fax: +86-755-8368 3166

Taiwan Office
BCD Semiconductor (Taiwan) Company Limited
4F, 298-1, Rui Guang Road, Nei-Hu District, Taipei,
Taiwan
Tel: +886-2-2656 2808, Fax: +886-2-2656 2806

USA Office
BCD Semiconductor Corporation
3170 De La Cruz Blvd., Suite 105, Santa Clara,
CA 95054-2411, U.S.A
Tel: +1-408-988 6388, Fax: +1-408-988 6386