

FODM121 Series, FODM124, FODM2701 Series, FODM2705 4-Pin Full Pitch Mini-Flat Package Transistor Output Optocouplers

Features

- >5mm creepage/clearance
- Compact 4-pin surface mount package (2.4mm maximum standoff height)
- Current Transfer Ratio in selected groups
DC Input:

FODM121: 50–600%	FODM2701: 50–300%
FODM121A: 100–300%	FODM2701A: 150–300%
FODM121B: 50–150%	FODM2701B: 80–160%
FODM121C: 100–200%	FODM124: 100% MIN
FODM121D: 50–100%	
FODM121E: 150–300%	
FODM121F: 100–600%	
FODM121G: 200–400%	
- AC Input:
FODM2705: 50–300%
- Available in tape and reel quantities of 500 and 2500
- Applicable to Infrared Ray reflow (260°C max, 10 seconds)
- C-UL, UL and VDE* certifications

*option 'V' required

Applications

- Digital logic inputs
- Microprocessor inputs
- Power supply monitor
- Twisted pair line receiver
- Telephone line receiver

Description

The FODM124, FODM121, and FODM2701 series consists of a gallium arsenide infrared emitting diode driving a phototransistor in a compact 4-pin mini-flat package. The lead pitch is 2.54 mm. The FODM2705 series consists of two gallium arsenide infrared emitting diodes connected in inverse parallel for AC operation.

Package Dimensions

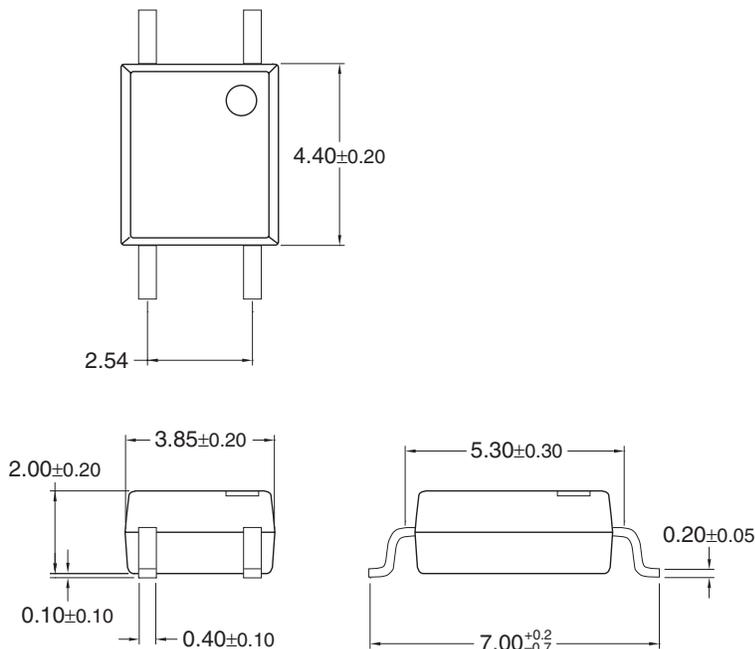

Note:

All dimensions are in millimeters.

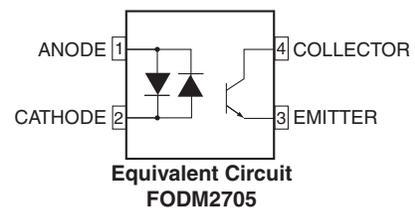
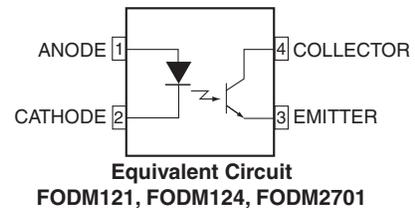
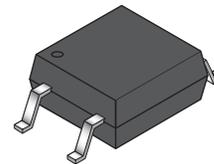

Absolute Maximum Ratings ($T_A = 25^\circ\text{C}$ unless otherwise specified)

Symbol	Parameter	Value	Units	
TOTAL PACKAGE				
T_{STG}	Storage Temperature	-40 to +125	$^\circ\text{C}$	
T_{OPR}	Operating Temperature	-40 to +110	$^\circ\text{C}$	
EMITTER				
I_F (avg)	Continuous Forward Current	50	mA	
I_F (pk)	Peak Forward Current (1 μs pulse, 300 pps.)	1	A	
V_R	Reverse Input Voltage	6	V	
P_D	Power Dissipation Derate linearly (above 25°C)	70	mW	
		0.65	mW/ $^\circ\text{C}$	
DETECTOR				
	Continuous Collector Current	80	mA	
P_D	Power Dissipation Derate linearly (above 25°C)	150	mW	
		2.0	mW/ $^\circ\text{C}$	
V_{CEO}	Collector-Emitter Voltage	FODM2701 Series, FODM2705	40	V
		FODM121 Series, FODM124	80	
V_{ECO}	Emitter-Collector Voltage	7	V	

Electrical Characteristics ($T_A = 25^\circ\text{C}$)

Individual Component Characteristics

Symbol	Parameter	Test Conditions	Device	Min.	Typ.*	Max.	Unit
EMITTER							
V_F	Forward Voltage	$I_F = 10\text{mA}$	FODM121 Series FODM124	1.0		1.3	V
		$I_F = 5\text{mA}$	FODM2701 Series			1.4	
		$I_F = \pm 5\text{mA}$	FODM2705				
I_R	Reverse Current	$V_R = 5\text{V}$	FODM2701 Series			5	μA
			FODM121 Series				
			FODM124				
DETECTOR							
BV_{CEO}	Breakdown Voltage Collector to Emitter	$I_C = 1\text{mA}, I_F = 0$	FODM121 Series FODM124	80			V
			FODM2701 Series FODM2705	40			
BV_{ECO}	Emitter to Collector	$I_E = 100\mu\text{A}, I_F = 0$	All	7		-	V
I_{CEO}	Collector Dark Current	$V_{CE} = 40\text{V}, I_F = 0$	All			100	nA
C_{CE}	Capacitance	$V_{CE} = 0\text{V}, f = 1\text{MHz}$	All		10		pF

Transfer Characteristics ($T_A = 25^\circ\text{C}$)

Symbol	Characteristic	Test Conditions	Device	Min.	Typ.**	Max.	Unit
CTR	DC Current Transfer Ratio	$I_F = \pm 5\text{mA}, V_{CE} = 5\text{V}$	FODM2705	50		300	%
			FODM2701	50		300	
			FODM2701A	150		300	
			FODM2701B	80		160	
		$I_F = 5\text{mA}, V_{CE} = 5\text{V}$	FODM121	50		600	
			FODM121A	100		300	
			FODM121B	50		150	
			FODM121C	100		200	
			FODM121D	50		100	
			FODM121E	150		300	
			FODM121F	100		600	
			FODM121G	200		400	
		$I_F = 1\text{mA}, V_{CE} = 0.4\text{V}$	FODM121F	30			
$I_F = 1\text{mA}, V_{CE} = 0.5\text{V}$	FODM124	100		1200			
$I_F = 0.5\text{mA}, V_{CE} = 1.5\text{V}$	FODM124	50					
	CTR Symmetry	$I_F = \pm 5\text{mA}, V_{CE} = 5\text{V}$	FODM2705	0.3		3.0	
$V_{CE(SAT)}$	Saturation Voltage	$I_F = \pm 10\text{mA}, I_C = 2\text{mA}$	FODM2705			0.3	V
			FODM2701			0.3	
			FODM2701A			0.3	
			FODM2701B			0.3	
		$I_F = 8\text{mA}, I_C = 2.4\text{mA}$	FODM121			0.4	
			FODM121A			0.4	
			FODM121B			0.4	
			FODM121C			0.4	
			FODM121D			0.4	
			FODM121E			0.4	
			FODM121F			0.4	
			FODM121G			0.4	
		$I_F = 1\text{mA}, I_C = 0.2\text{mA}$	FODM121F			0.4	
$I_F = 1\text{mA}, I_C = 0.5\text{mA}$	FODM124			0.4			
t_r	Rise Time (Non-Saturated)	$I_C = 2\text{mA}, V_{CE} = 5\text{V}, R_L = 100\Omega$	All		3		μs
t_f	Fall Time (Non-Saturated)	$I_C = 2\text{mA}, V_{CE} = 5\text{V}, R_L = 100\Omega$	All		3		μs

Isolation Characteristics

Characteristic	Test Conditions	Symbol	Device	Min.	Typ.*	Max.	Unit
Steady State Isolation Voltage ⁽¹⁾	1 Minute	V_{ISO}	All	3750			VRMS

*All typicals at $T_A = 25^\circ\text{C}$

Note:

1. Steady state isolation voltage, V_{ISO} , is an internal device dielectric breakdown rating. For this test, pins 1 and 2 are common, and pins 3 and 4 are common.

Typical Performance Curves

Fig. 1 Forward Current vs. Forward Voltage

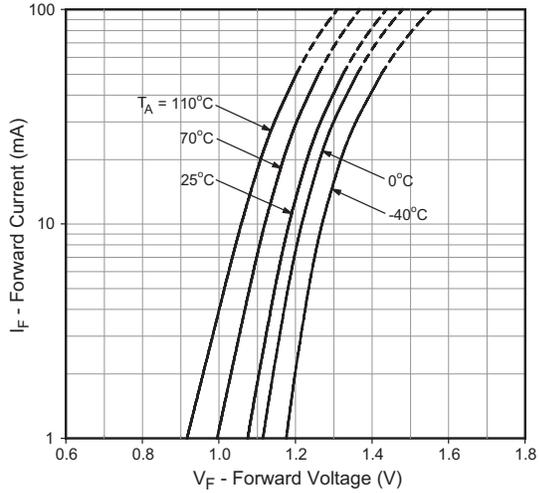

Fig. 2 Collector-Emitter Saturation Voltage vs. Ambient Temperature (FODM121/2701/2705)

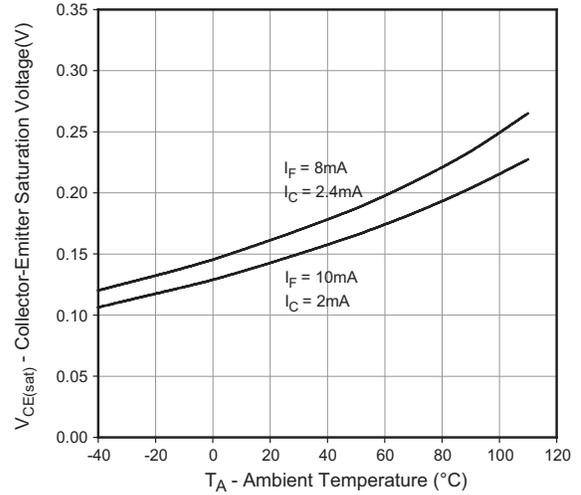

Fig. 3 Current Transfer Ratio vs. Forward Current (FODM121/2701/2705)

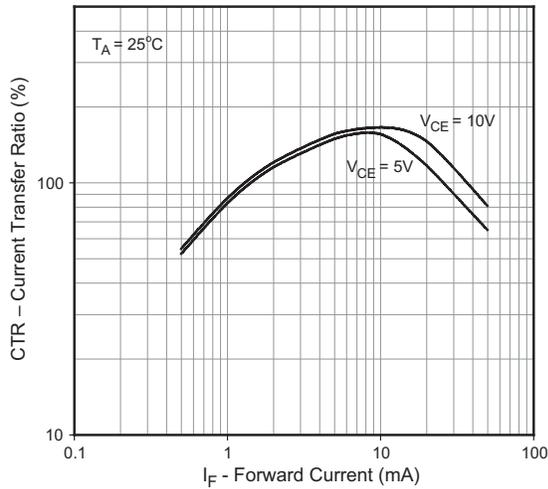

Fig. 4 Collector Current vs. Forward Current (FODM121/2701/2705)

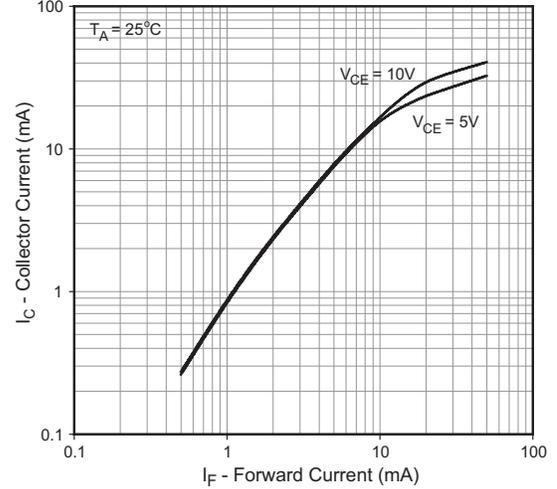

Fig. 5 Collector Current vs. Ambient Temperature (FODM121/2701/2705)

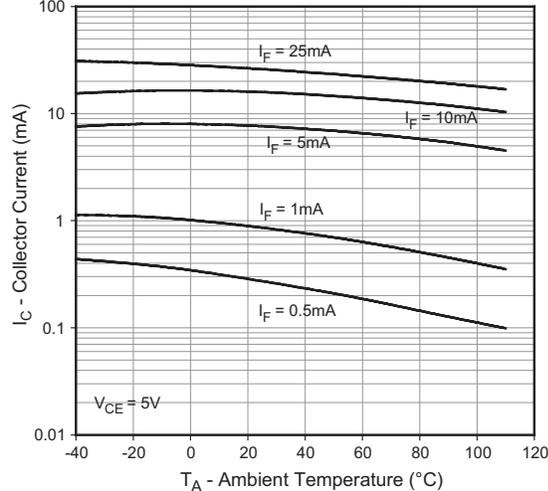

Fig. 6 Collector Current vs. Collector-Emitter Voltage (FODM121/2701/2705)

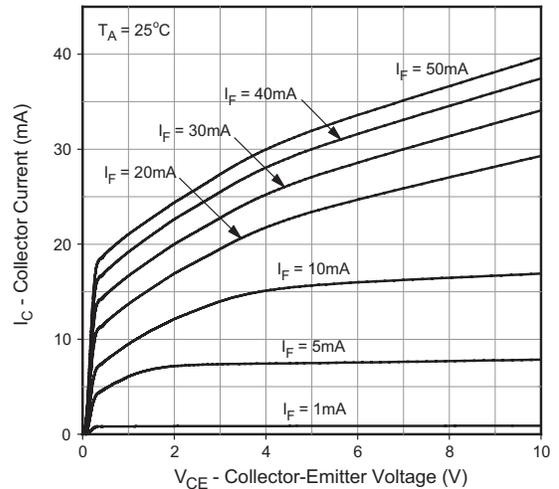

Fig 7. Collector Dark Current vs. Ambient Temperature (FODM121/2701/2705)

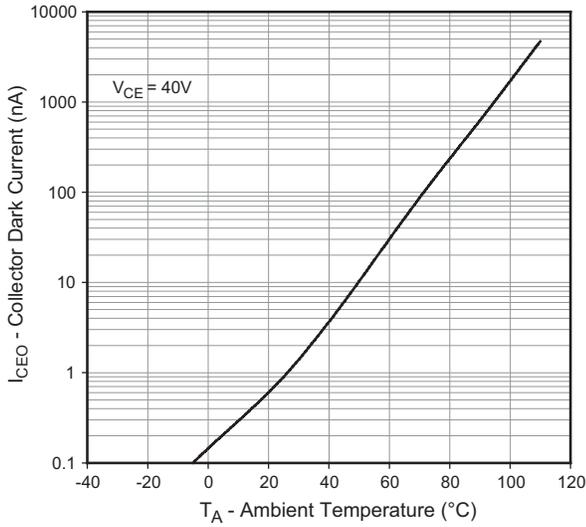

Fig. 8 Normalized Current Transfer Ratio vs. Ambient Temperature (FODM121/2701/2705)

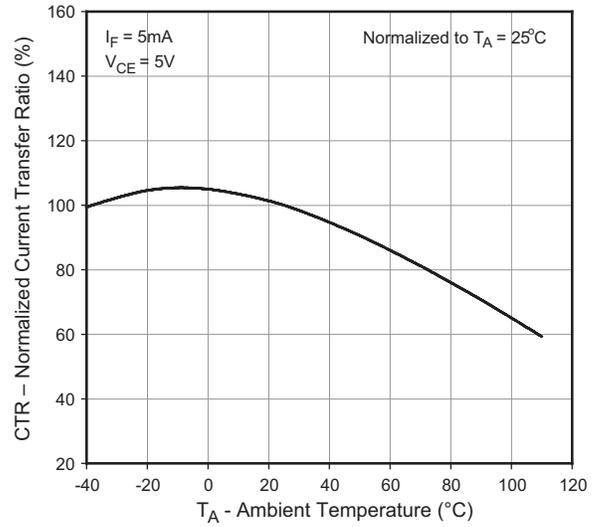

Fig. 9 Switching Time vs. Load Resistance (FODM121/2701/2705)

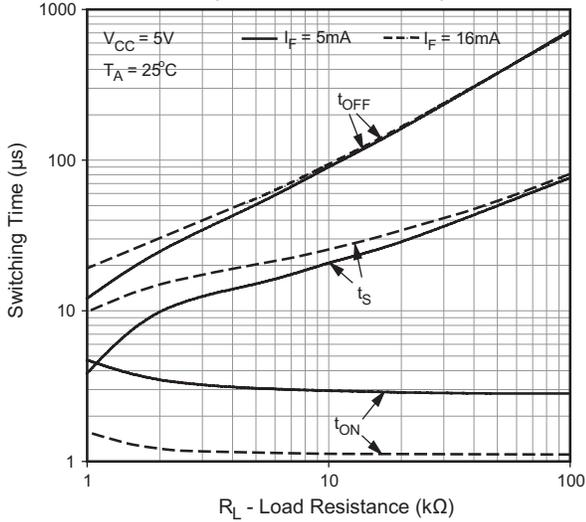

Fig. 10 Collector-Emitter Saturation Voltage vs. Ambient Temperature (FODM124)

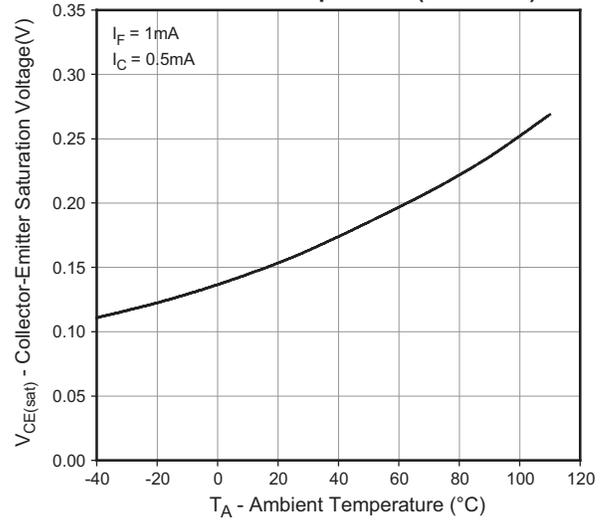

Fig. 11 Current Transfer Ratio vs. Forward Current (FODM124)

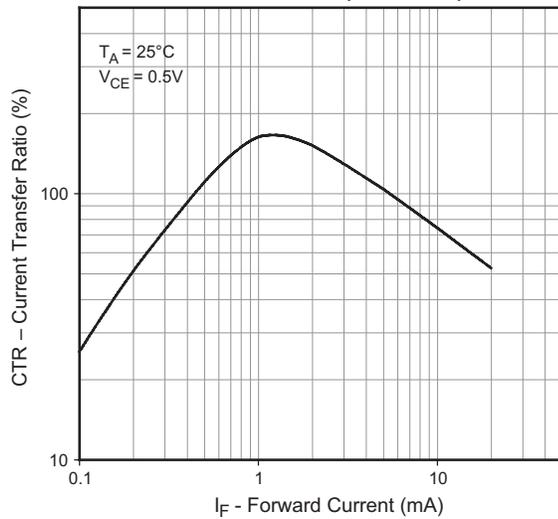

Fig 12. Collector Current vs. Forward Current (FODM124)

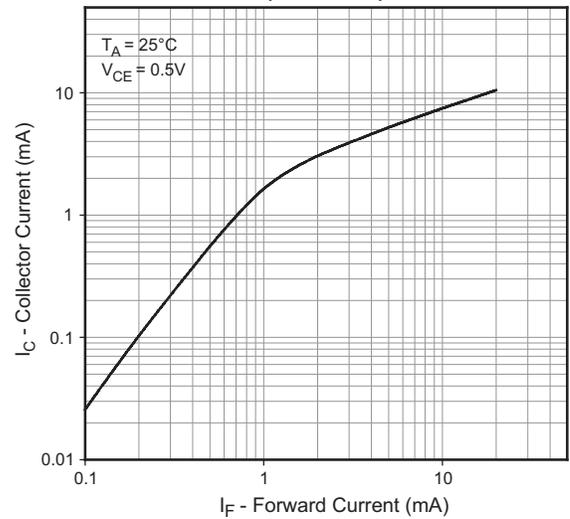

Fig 13. Collector Current vs. Ambient Temperature (FODM124)

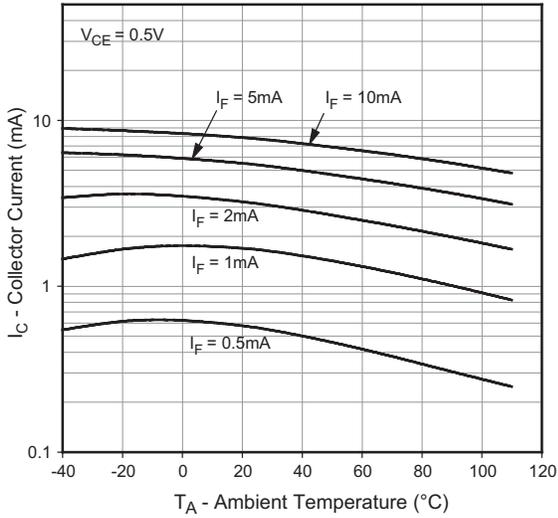

Fig 14 Collector Current vs. Collector-Emitter Voltage (FODM124)

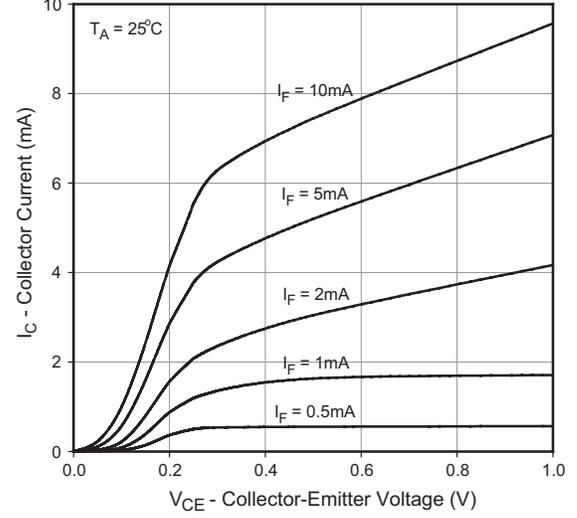

Fig 15 Collector Dark Current vs. Ambient Temperature (FODM124)

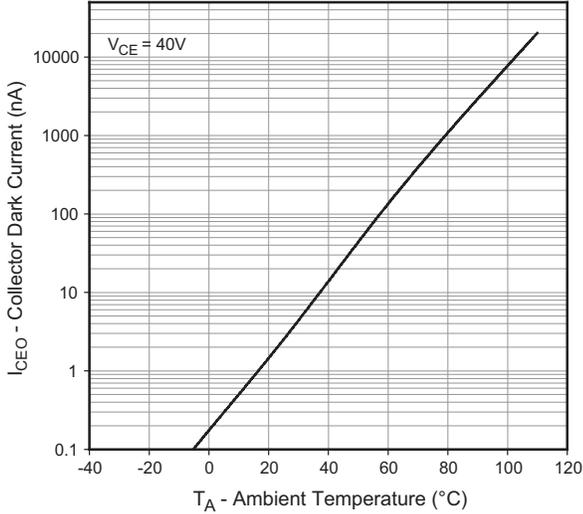

Fig 16 Normalized Current Transfer Ratio vs. Ambient Temperature (FODM124)

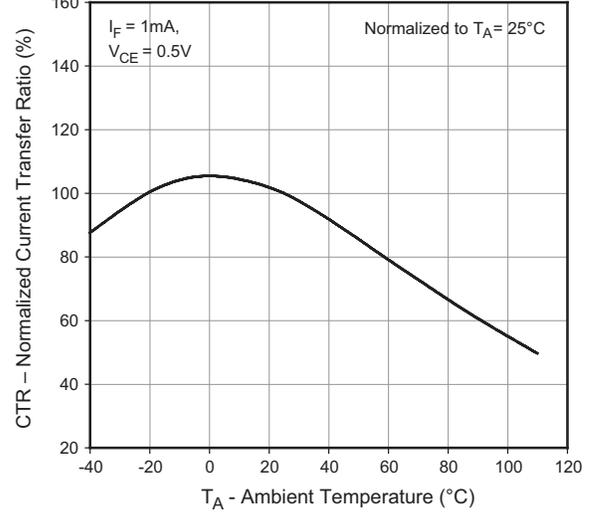
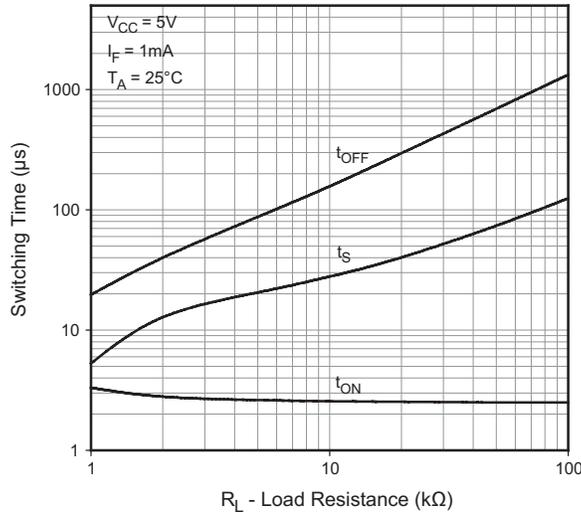

Fig 17 Switching Time vs. Load Resistance (FODM124)



Ordering Information

Option	Description
V	VDE Approved
R1	Tape and Reel (500 units)
R2	Tape and Reel (2500 units)
R1V	Tape and Reel (500 units) and VDE Approved
R2V	Tape and Reel (2500 units) and VDE Approved

Marking Information

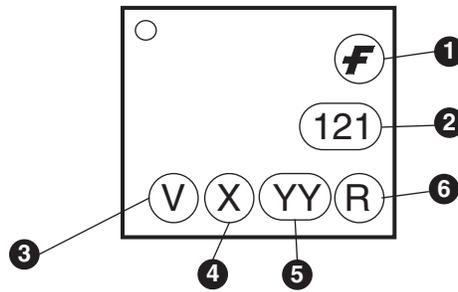

Definitions	
1	Fairchild logo
2	Device number
3	VDE mark (Note: Only appears on parts ordered with VDE option – See order entry table)
4	One digit year code
5	Two digit work week ranging from '01' to '53'
6	Assembly package code

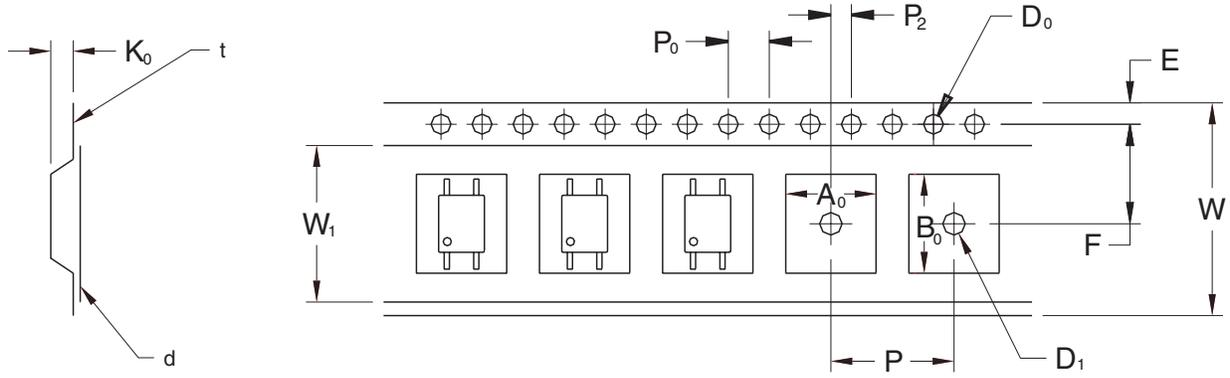

Description		Symbol	2.54 Pitch Dimensions (mm)
Tape Width		W	12.00±0.4
Tape Thickness		t	0.35±0.02
Sprocket Hole Pitch		P ₀	4.00±0.20
Sprocket Hole Dia.		D ₀	1.55±0.20
Sprocket Hole Location		E	1.75±0.20
Pocket Location		F	5.50±0.20
		P ₂	2.00±0.20
Pocket Pitch		P	8.00±0.20
Pocket Dimension		A ₀	4.75±0.20
		B ₀	7.30±0.20
		K ₀	2.30±0.20
Pocket Hole Dia.		D ₁	1.55±0.20
Cover Tape Width		W ₁	9.20
Cover Tape Thickness		d	0.065±0.02
Max. Component Rotation or Tilt			20° max
Devices Per Reel	R1		500
	R2		2500
Reel Diameter	R1		178 mm (7")
	R2		330 mm (13")

Footprint Drawing for PCB Layout

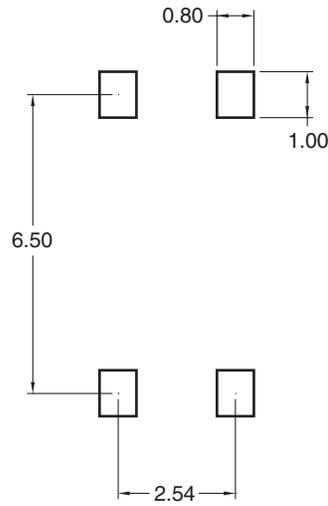

Note:
All dimensions are in mm.

Recommended Infrared Reflow Soldering Profile

- Peak reflow temperature: 260°C (package surface temperature)
- Time of temperature higher than 245°C: 40 seconds or less
- Number of reflows: 3

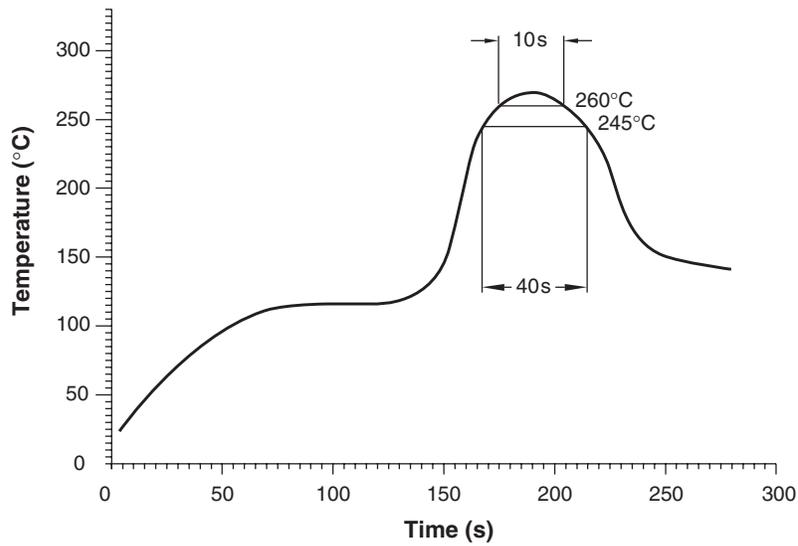

FAIRCHILD SEMICONDUCTOR TRADEMARKS

The following are registered and unregistered trademarks Fairchild Semiconductor owns or is authorized to use and is not intended to be an exhaustive list of all such trademarks.

ACEx™	FACT Quiet Series™	OCX™	SILENT SWITCHER®	UniFET™
ActiveArray™	GlobalOptoisolator™	OCXPro™	SMART START™	VCX™
Bottomless™	GTO™	OPTOLOGIC®	SPM™	Wire™
Build it Now™	HiSeC™	OPTOPLANAR™	Stealth™	
CoolFET™	I ² C™	PACMAN™	SuperFET™	
CROSSVOLT™	i-Lo™	POP™	SuperSOT™-3	
DOME™	ImpliedDisconnect™	Power247™	SuperSOT™-6	
EcoSPARK™	IntelliMAX™	PowerEdge™	SuperSOT™-8	
E ² CMOS™	ISOPLANAR™	PowerSaver™	SyncFET™	
EnSigna™	LittleFET™	PowerTrench®	TCM™	
FACT®	MICROCOUPLER™	QFET®	TinyBoost™	
FAST®	MicroFET™	QST™	TinyBuck™	
FASTr™	MicroPak™	QT Optoelectronics™	TinyPWM™	
FPST™	MICROWIRE™	Quiet Series™	TinyPower™	
FRFET™	MSX™	RapidConfigure™	TinyLogic®	
	MSXPro™	RapidConnect™	TINYOPTO™	
Across the board. Around the world.™		µSerDes™	TruTranslation™	
The Power Franchise®		ScalarPump™	UHC®	
Programmable Active Droop™				

DISCLAIMER

FAIRCHILD SEMICONDUCTOR RESERVES THE RIGHT TO MAKE CHANGES WITHOUT FURTHER NOTICE TO ANY PRODUCTS HEREIN TO IMPROVE RELIABILITY, FUNCTION, OR DESIGN. FAIRCHILD DOES NOT ASSUME ANY LIABILITY ARISING OUT OF THE APPLICATION OR USE OF ANY PRODUCT OR CIRCUIT DESCRIBED HEREIN; NEITHER DOES IT CONVEY ANY LICENSE UNDER ITS PATENT RIGHTS, NOR THE RIGHTS OF OTHERS. THESE SPECIFICATIONS DO NOT EXPAND THE TERMS OF FAIRCHILD'S WORLDWIDE TERMS AND CONDITIONS, SPECIFICALLY THE WARRANTY THEREIN, WHICH COVERS THESE PRODUCTS.

LIFE SUPPORT POLICY

FAIRCHILD'S PRODUCTS ARE NOT AUTHORIZED FOR USE AS CRITICAL COMPONENTS IN LIFE SUPPORT DEVICES OR SYSTEMS WITHOUT THE EXPRESS WRITTEN APPROVAL OF FAIRCHILD SEMICONDUCTOR CORPORATION.

As used herein:

- Life support devices or systems are devices or systems which, (a) are intended for surgical implant into the body, or (b) support or sustain life, or (c) whose failure to perform when properly used in accordance with instructions for use provided in the labeling, can be reasonably expected to result in significant injury to the user.
- A critical component is any component of a life support device or system whose failure to perform can be reasonably expected to cause the failure of the life support device or system, or to affect its safety or effectiveness.

PRODUCT STATUS DEFINITIONS

Definition of Terms

Datasheet Identification	Product Status	Definition
Advance Information	Formative or In Design	This datasheet contains the design specifications for product development. Specifications may change in any manner without notice.
Preliminary	First Production	This datasheet contains preliminary data, and supplementary data will be published at a later date. Fairchild Semiconductor reserves the right to make changes at any time without notice to improve design.
No Identification Needed	Full Production	This datasheet contains final specifications. Fairchild Semiconductor reserves the right to make changes at any time without notice to improve design.
Obsolete	Not In Production	This datasheet contains specifications on a product that has been discontinued by Fairchild semiconductor. The datasheet is printed for reference information only.

Rev. I22