

Features

- Single Output up to 25A
Dual Outputs Total Power up to 100W
- Input/Output 1.6kVDC Isolation
- Adjustable Output Voltage
- Under-Voltage Lockout
- No Minimum Load
- Industry Standard Footprint
- Fixed Operating Frequency
- Halt Tested
- Compact 61.0 x 57.91 x 12.7mm Package
- High Efficiency to 90%

INNOLINE
DC/DC-Converter

RP100-S_DI Series

Selection Guide

Part Number	Input Voltage (VDC)	Output Voltage (VDC)	Output Current (A)	Line Regulation (mV)	Load Regulation (mV)	Input Current ⁽⁸⁾ (A)	Efficiency ⁽⁹⁾ %
Single Output							
RP100-481.8S	36 – 75	1.8	25	4	6	1.157	86
RP100-482.5S	36 – 75	2.5	25	5	8	1.608	87
RP100-483.3S	36 – 75	3.3	25	7	10	2.022	90
RP100-4805S	36 – 75	5	20	10	15	2.480	90
RP100-4815S	36 – 75	15	6.66	30	45	2.507	90

Part Number	Input Voltage (VDC)	Output Voltage V1 / V2 (VDC)	Output Current I1 / I2 (A)	Line Regulation V1 / V2 (mV)	Load Regulation V1 / V2 (mV)	Input Current ⁽⁸⁾ (A)	Efficiency ⁽⁹⁾ %
Dual Output							
RP100-483.305DI	36 – 75	5 / 3.3	20 / 25	25 / 16.5	25 / 16.5	2.39	87
RP100-482.505DI	36 – 75	5 / 2.5	20 / 25	25 / 12.5	25 / 12.5	2.45	85
RP100-482.53.3DI	36 – 75	3.3 / 2.5	25 / 25	16.5 / 12.5	16.5 / 12.5	2.44	85

Notes:

- Maximum output deviation is 10% inclusive of remote sense. If remote sense is not being used, the +Vsense should be connected to its corresponding +Vout and likewise the -Vsense should be connected to its corresponding -Vout.
- Single: Measured with a 1uF M/C and a 10uF T/C.
Dual: For each outputs.
- An external filter capacitor is required for normal operation.
The capacitor should be capable of handling 1A ripple current for 48V models.
RECOM suggest: Nippon chemi-con KMF series, 220uF/100V, ESR 90mΩ.
- Single: The negative / positive logic and length are optional (see table).
The pin voltage is referenced to negative input.
Dual: The ON/OFF control function. There are positive logic (standard) and negative logic (option).
The pin voltage is referenced to negative input.
To order negative logic ON/OFF control add the suffix-N. (Ex:RP100-483.305I/N)
- BELLCORE TR-NWT-000332. Case I: 50% Stress, Temperature at 40°C.
(Ground fixed and controlled environment)
- Heat sink is optional and P/N: 7G-0021, 7G-0022, 7G-0023, 7G-0024.
- The RP100 meets level A and level B conducted emissions only with external components connected before the input pin to the converter.
- Maximum value at nominal input voltage and full load.
- Typical value at nominal input voltage and full load.
The dual efficiency test condition: RP100-483.305DI @ 5V/12A and 3.3V/12A
RP100-482.505DI @ 5V/12A and 2.5V/16A
RP100-482.53.3DI @ 3.3V/18A and 2.5V/16A
- BASEPLATE GROUNDING: Base-plate should be grounded at one of four screw bolts prior to operation.
- The converter is provided by basic insulation.
- "N" for Negative remote ON/OFF.
- "P" for Positive remote ON/OFF.

**100 Watt
Isolated
Single &
Dual Output**



RECOM

Specifications (refer to the standard application circuit, Ta: 25°C)

Input Voltage Range	36-75VDC	48V nom.
Over-Voltage Lockout Start-up Voltage	Dual	76.5V typ.
Over-Voltage Lockout Shutdown Voltage	Dual	78.5V typ.
Unde-Voltage Lockout Start-up Voltage	Single Dual	34V typ. 35V typ.
Unde-Voltage Lockout Shutdown Voltage	Single Dual	32V typ. 33V typ.
Input Filter (Note 3)		L-C type
Input voltage variation	dv/dt	5V/ms max (Complies with ETS300 132 part4.4)
Input Surge Voltage 100mS max	Single	100VDC
Start up time	Nominal Vin and constant resistive load	Single 25mS typ.
Input Reflected-Ripple Current (5Hz to 20Hz, 12uH Source impedance)	Single	20mA _{p-p}
Remote ON/OFF (Note 4)		
Single (Positive logic)	ON=Open or 3.5V < Vr < 15V, OFF=Short or 0V < Vr < 1.2V,	I _N =50μA max. I _N =1mA max.
Single (Negative logic)	ON=Short or 0V < Vr < 1.2V, OFF=Open or 3.5V < Vr < 15V,	I _N =1mA max. I _N =50μA max.
Dual (Positive logic)	ON=Open or 3.5V < Vr < +Vin, OFF=Short or Vr < 1.2V,	
Dual (Negative logic)	ON=Short or 3.5V < Vr < +Vin, OFF=Open or Vr < 1.2V.	
Continuous Output Power		100W max.
Output Voltage Accuracy (Full load and nominal Vin)	Single Dual	±1.5% ±1.0%
Output Voltage Adjustment (Note 1)	Single Dual	+10%, -20% ±10%
Minimum Load		0%
Line Regulation	LL to HL at FL	See table
Load Regulation	Single 0% to 100% FL Dual 0% to 100% FL Dual for each Outputs	See table
Remote Sense (Note 1)		10% of Vout
Ripple and Noise 20MHz bandwidth (Note 2)		100mV _{p-p}
Temperature Coefficient		±0.02%/°C
Transient Response Recovery Time (25% load step change)		200us
Over Voltage Protection threshold (Hiccup)	Single & Dual 2.5V 3.3V 5V	115% ~ 130% of Vout 3.0V 3.9V 6.2V
Over Current Protection threshold		110% ~ 140% of Iout Rated
Short Circuit Protection		Hiccup, Automatic recovery
Efficiency (at nominal input voltage, full load)		up to 90%

Continued next page

Specifications (refer to the standard application circuit, Ta: 25°C)

Isolation Voltage	Input to Output	1.600VDC min.
	Input to Case	1.000VDC min.
	Output to Case	1.000VDC min.
Isolation Resistance	Single	10 ⁷ ohms min.
	Dual	10 ⁹ ohms min.
Isolation Capacitance	Single	2.500pF max.
	Dual	1.500pF max.
Operating Frequency		300KHz typ.
Operating Base-plate Temperature Range (Note 6)		-40°C to +100°C
Over Temperature Protection	Single	110°C
	Dual for Base-plate	105°C
Storage Temperature Range		-55°C to +125°C
Humidity max., Non-condensing		95%
Thermal Shock		MIL-STD-810D
Vibration	10 ~ 55Hz 2G, 3minutes period, 30minutes analog	X, Y and Z
Conducted Emissions	EN55022 (Note 7)	Level A
	EN55022 (Note 7)	Level B
Radiated Emissions	EN55022	Level A
ESD	EN61000-4-2	Perf. Criteria2
Radiated Immunity	EN61000-4-3	Perf. Criteria2
Fast Transient	EN61000-4-4	Perf. Criteria2
Surge	EN61000-4-5	Perf. Criteria2
Conducted Immunity	EN61000-4-6	Perf. Criteria2
Case Material	Dual	Non-conductive black plastic
Base material		Aluminum base-plate
Potting material	Dual	Silicon (UL94-V0)
Weight	Single	55g
	Dual	105g
MTBF (Note 6)	Single	2 x 10 ⁶ hrs
		1.004 x 10 ⁶ hrs

Characteristics

Efficiency vs Output Load

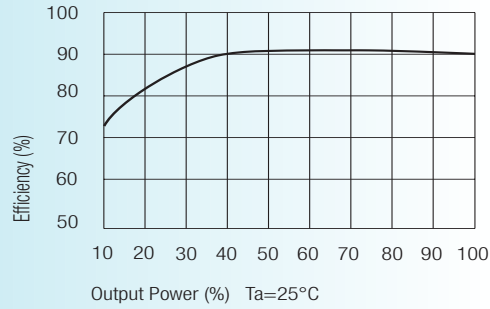

48V Input Without Heatsink

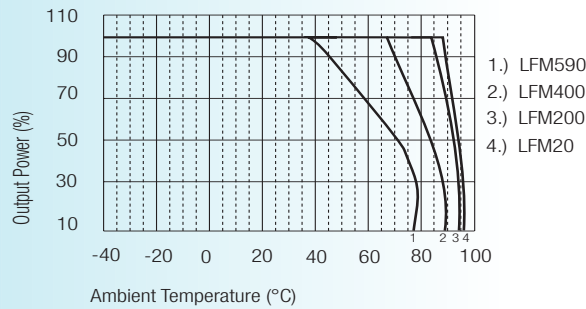

48V Input With Heatsink (7G-0022)

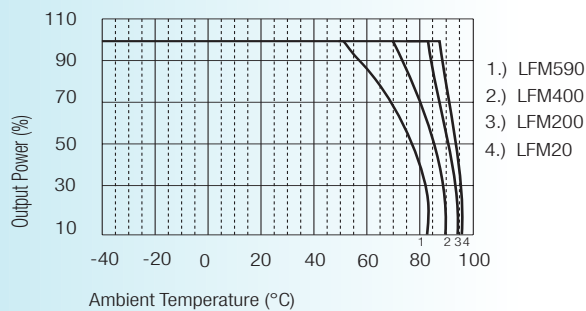

Package Style and Pinning (mm)

Single Output

3rd angle projection 

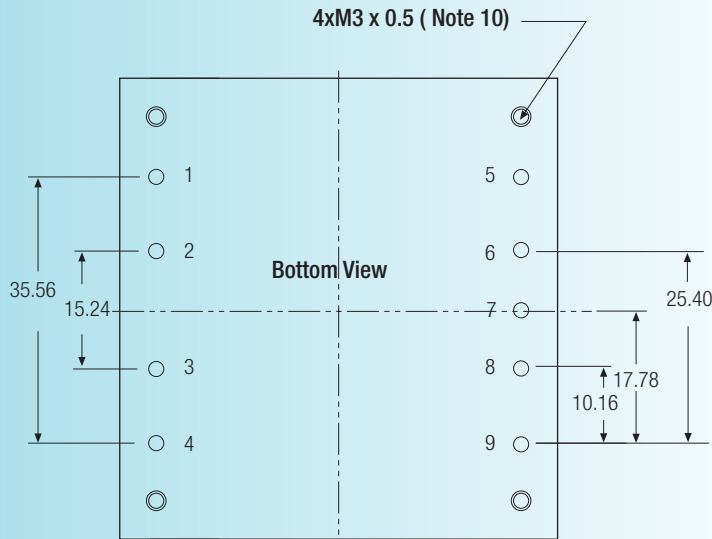
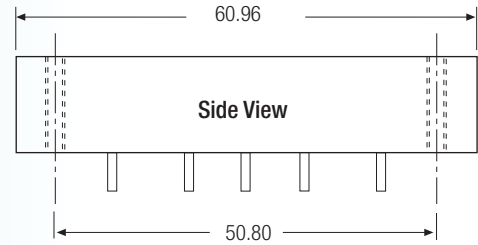
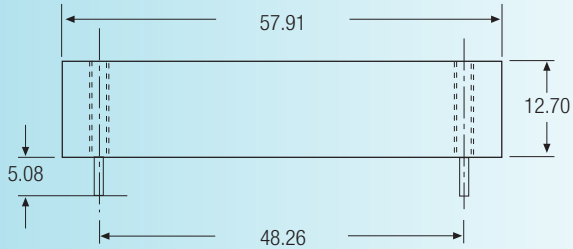

Pin Connections

Pin #	Function	Pin Ø
1	-Vin	1.016 mm
2	Case	1.016 mm
3	Remote ON/OFF	1.016 mm
4	+Vin	1.016 mm
5	-Vout	2.032 mm
6	-Vsense	1.016 mm
7	Trim	1.016 mm
8	+Vsense	1.016 mm
9	+Vout	2.032 mm

XX.X ± 0.5 mm
XX.XX ± 0.25 mm
Pin pitch tolerance 0.35mm

External Output Trimming

Output can be externally trimmed by using the method shown below.
See application notes for values.

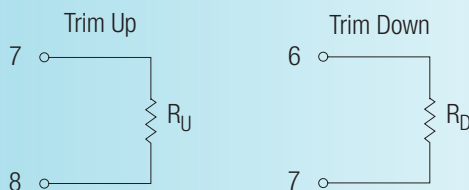

Product Options Table

Option	Suffix
Negative remote ON/OFF logic, 0.20" pin length (standard)	
Negative remote ON/OFF logic, 0.145" pin length	L
Negative remote ON/OFF logic, 0.11" pin length	K
Positive remote ON/OFF logic, 0.20" pin length	P
Positive remote ON/OFF logic, 0.145" pin length	S
Positive remote ON/OFF logic, 0.11" pin length	M

Example: RP100-483.3S/P

Package Style and Pinning (mm)

Dual Output

3rd angle projection

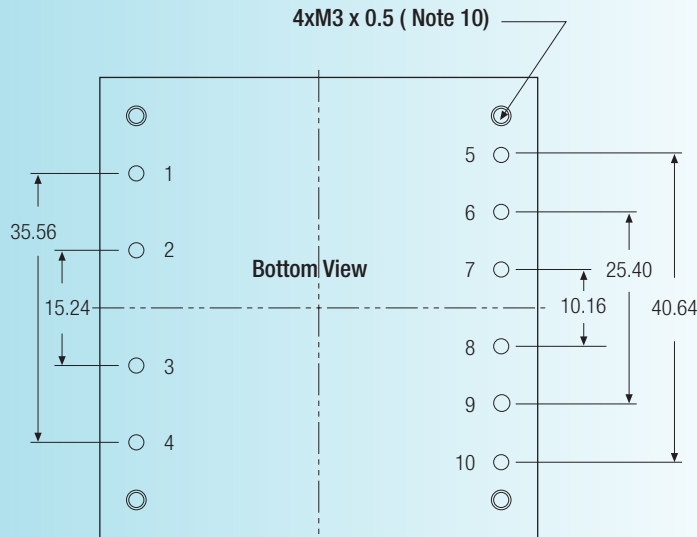
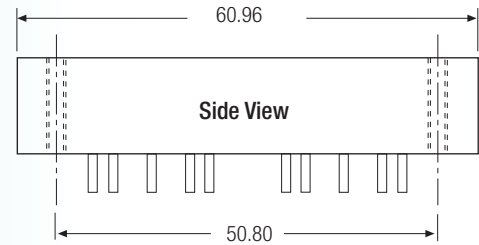
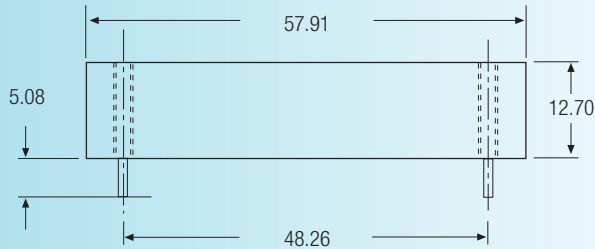

Pin Connections

Pin #	Function	Pin Ø
1	-Vin	1.016 mm
2	Case	1.016 mm
3	Remote ON/OFF	1.016 mm
4	+Vin	1.016 mm
5	+V2	2.032 mm
6	-V2 (Com)	2.032 mm
7	V2 Trim	1.016 mm
8	+V1	2.032 mm
9	+V1 (Com)	2.032 mm
10	V1 Trim	1.016 mm

XX.X ± 0.5 mm
XX.XX ± 0.25 mm
Pin pitch tolerance 0.35mm

External Output Trimming

Output can be externally trimmed by using the method shown below. See application notes for values.

() for V2 output trim

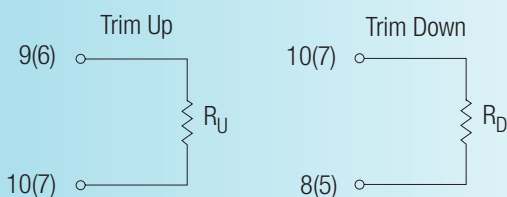

Product Options Table

Option	Suffix
Negative remote ON/OFF logic, 0.20" pin length (standard)	
Negative remote ON/OFF logic, 0.145" pin length	L
Negative remote ON/OFF logic, 0.11" pin length	K
Positive remote ON/OFF logic, 0.20" pin length	P
Positive remote ON/OFF logic, 0.145" pin length	S
Positive remote ON/OFF logic, 0.11" pin length	M

Example: RP100-483.305I/N