

Features

- Single Outputs up to 25A
- Input/Output 1.6kVDC Isolation
- Adjustable Output Voltage
- No Minimum Load
- Under -Voltage Lockout
- Industry Standard Footprint
- Fixed Operating Frequency
- Halt Tested
- Compact 36.83 x 57.91 x 12.7mm Package
- High Efficiency to 91%

INNOLINE
DC/DC-Converter

RP75-SB Series

**75 Watt
Single
Output**

Selection Guide

Part Number	Input Voltage (VDC)	Output Voltage (VDC)	Output Current (A)	Load Regulation (mV)	Efficiency ⁽⁵⁾ (%)
RP75-481.8SB	36 – 75	1.8	25	5.4	85
RP75-482.5SB	36 – 75	2.5	25	7.5	87
RP75-483.3SB	36 – 75	3.3	20	10	90
RP75-4805SB	36 – 75	5.0	15	15	90

Add suffix "P" for positive logic ON/OFF control.



Description

The RP75-SB Series has been specifically designed for low voltage silicon applications. A wide input voltage range, output voltage trim and sense inputs are all standard features. The converters also benefit from comprehensive over-current, over-voltage and over-temperature protection. The RP75-SB is ideally suited to telecom, network and industrial applications.

RECOM

Notes:

1. Maximum output deviation is 10% inclusive of remote sense. If remote sense is not being used, the +Vsense should be connected to its corresponding +Vout
2. The pin voltage is referenced to negative input.
3. Heat sink is optional and P/N: 7G-0021, 7G-0022, 7G-0023, 7G-0024.
4. The RP75-SB meets level A and level B conducted emissions only with external components connected before the input pin to the converter.
5. Typical value at nominal input voltage and full load.
6. BASEPLATE GROUNDING : Base-plate should be grounded at one of the four screw bolts prior to operation.

Specifications (refer to the standard application circuit, Ta: 25°C)

Input Voltage Range	36-75VDC	(48V nom.)
Under-Voltage Lockout	Power Up	34V typ.
	Power Down	32V typ.
Input Filter		L-C type
Input Surge Voltage 100ms max		100VDC
Start up time	Nominal Vin and constant resistive load	25ms typ.
Remote ON/OFF (Note 2)		
(Positive logic)	ON=Open or $3.0V < V_r < 15V$, OFF=Short or $0V < V_r < 1.2V$,	$I_{IN}=1mA$ max. $I_{IN}=50\mu A$ max.
(Negative logic)	ON=Short or $0V < V_r < 1.2V$, OFF=Open or $3.0V < V_r < 15V$,	$I_{IN}=1mA$ max. $I_{IN}=50\mu A$ max.
Continuous Output Power		75W max.
Output Voltage Accuracy	Full load and nominal Vin	$\pm 1.5\%$
Output Voltage Adjustment (Note 1)		+10%, -20%
Minimum Load		0%
Line Regulation	low line to high line at full load	$\pm 0.2\%$
Load Regulation	0% to 100% full load	See table
Remote Sense (Note 1)		10% of Vout
Ripple and Noise 20MHz bandwidth	With 10 μ F tantalum and 1 μ F ceramic across Output	100mVp-p
Temperature Coefficient		$\pm 0.02\%/^{\circ}C$
Transient Response Recovery Time	25% load step change	200 μ s
Over Voltage Protection threshold (Hiccup)		120% of Vout
Over Current Protection threshold		110% ~ 140% of Iout Rated
Short Circuit Protection		Hiccup, Automatic recovery
Efficiency (at nominal input voltage, full load)		see table
Isolation Voltage	Input to Output Input to Case Output to Case	1600VDC min. 1000VDC min. 1000VDC min.
Isolation Resistance		10 M Ω min.
Isolation Capacitance		2500pF max.
Operating Frequency		270KHz typ.
Operating Temperature Range (Note 3)		-40°C to +100°C (base plate)
Over Temperature Protection		110°C
Storage Temperature Range		-55°C to +125°C
Humidity max., Non-condensing		95%
Thermal Shock		MIL-STD-810D
Vibration	10 ~ 55Hz 2G, 3minutes period, 30minutes analog	X, Y and Z
Humidity	Non Condensing	95% max.
Conducted Emissions	EN55022 (Note 4)	Level A
	EN55022 (Note 4)	Level B
Radiated Emissions	EN55022 (Note 4)	Level A

Continued on next page

Specifications (refer to the standard application circuit, Ta: 25°C)

ESD	EN61000-4-2	Perf. Criteria2
Radiated Immunity	EN61000-4-3	Perf. Criteria2
Fast Transient	EN61000-4-4	Perf. Criteria2
Surge	EN61000-4-5	Perf. Criteria2
Conducted Immunity	EN61000-4-6	Perf. Criteria2
Case Material	Open with Aluminium base plate	
Weight	42g	
MTBF Bellcore TR-NWT-000332, Tc=40°C, Io=80% max.	2500 x 10 ³ hours	

Characteristics

**Efficiency Input Voltage
RP75-4805SB**

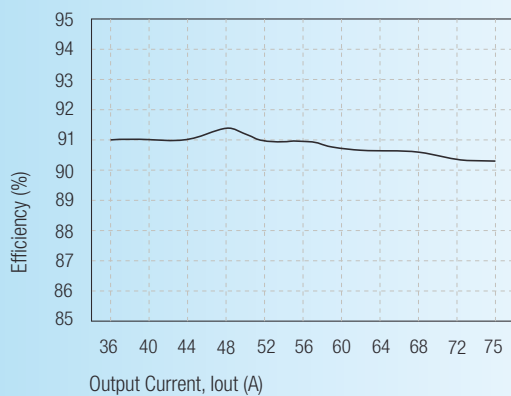

**Efficiency Output Current Iout
RP75-4805SB**

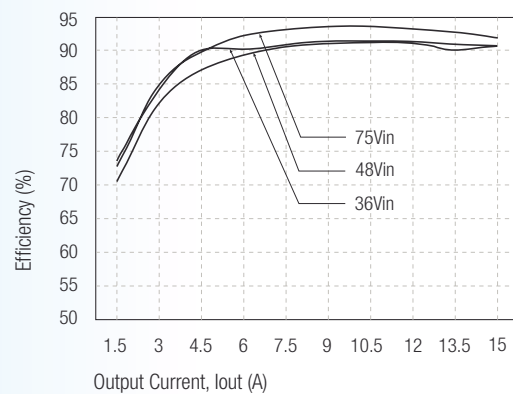

**Input Without Heatsink
RP75-4805SB**

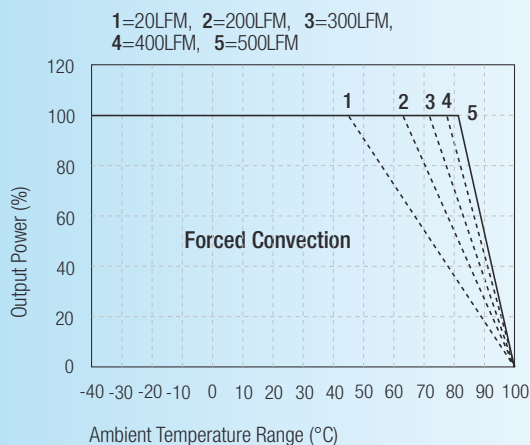

**Input With Heatsink (7G-0022)
RP75-4805SB**

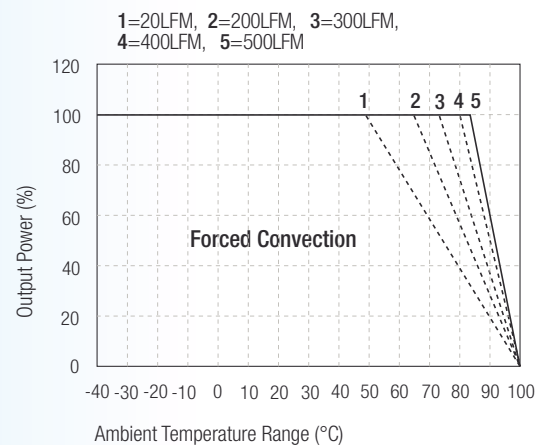

Package Style and Pinning (mm)

3rd angle projection 

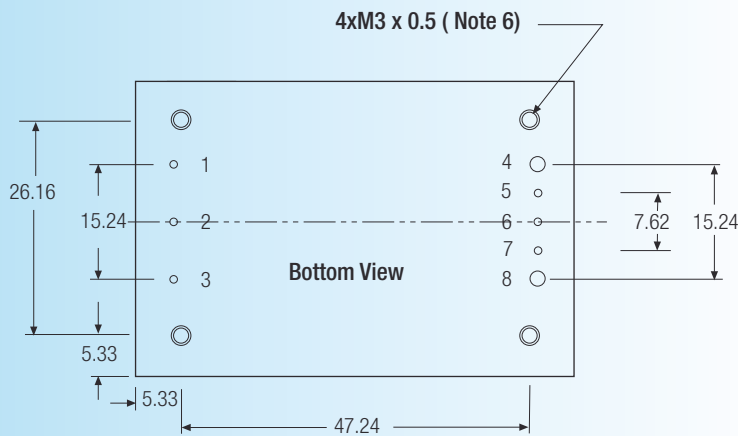
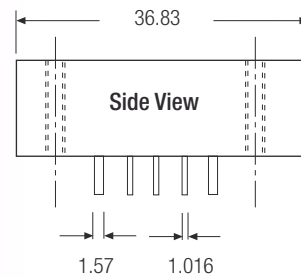
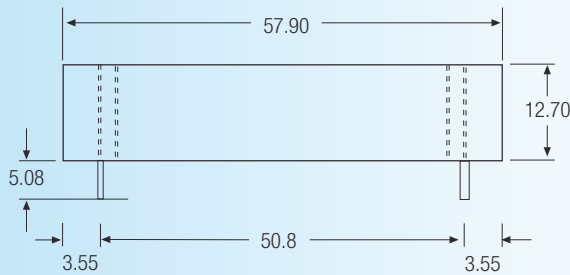

Pin Connections

Pin #	Function
1	-Vin
2	Remote ON/OFF
3	+Vin
4	-Vout
5	-Vsense
6	Trim
7	+Vsense
8	+Vout

XX.X ± 0.5 mm
XX.XX ± 0.25 mm
Pin pitch tolerance 0.35mm

External Output Trimming

Output can be externally trimmed by using the method shown below.

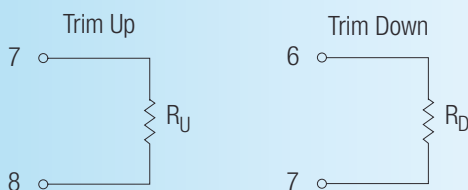

Trim Resistor Calculation:

$$R_{up} (k\Omega) = \frac{5.1V_{out} (100+\Delta\%) - 510}{1.225\Delta\%} - 10.2$$

$$R_{dn} (k\Omega) = \frac{510}{\Delta\%} - 10.2$$