



USBULC6-2F3

IPAD™

Dual ultra low capacitance protection for high speed USB

Main application

- Hi-Speed USB port in wireless handsets (up to 480 Mb/s according to USB 2.0 High Speed Specification)

Features

- Ultra low diode capacitance (1.2 pF max)
- Two data lines (D+ and D-) protected against 15 kV ESD
- Breakdown Voltage $V_{BR} = 6.0 \text{ V min}$
- Flip-Chip 400 μm pitch, lead-free
- Very low leakage current
- Very small PCB area
- RoHS compliant

Description

The USBULC6-2F3 is a monolithic, application specific discrete device dedicated to ESD protection of high speed interfaces.

Its ultra low line capacitance secures a high level of signal integrity without compromising the protection of downstream sensitive chips against the most stringently characterized ESD strikes.

Benefits

- Minimized impact on rise and fall times for maximum data integrity
- Low PCB space occupation
- Higher reliability offered by monolithic integration

Complies with the following standards:

IEC 61000-4-2: 15 kV (air discharge)
8 kV (contact discharge)

MIL STD 883G - Method 3015.7

25 kV (Human body model)

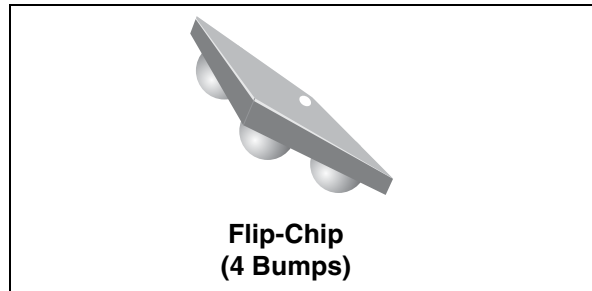

Pin configuration (bump side)

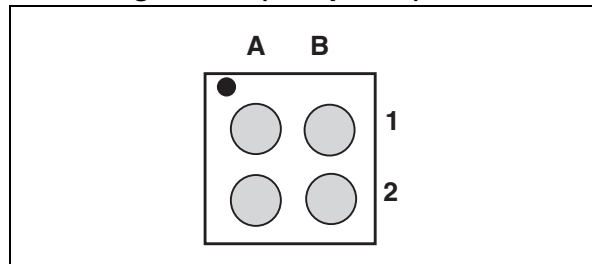

Configuration

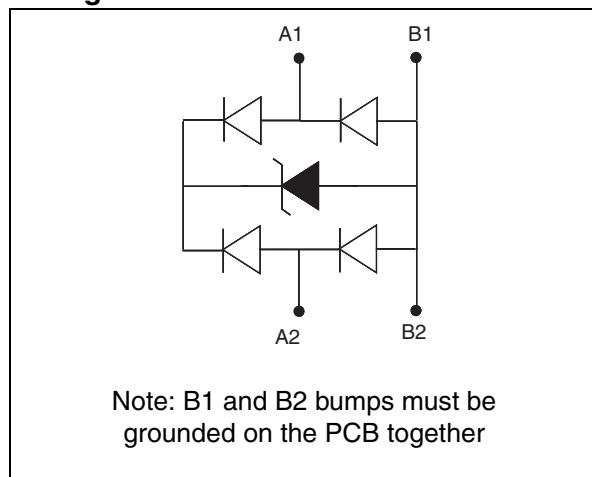

Order code

Part Number	Marking
USBULC6-2F3	EH

TM: IPAD is a trademark of STMicroelectronics

1 Characteristics

Table 1. Absolute Maximum Ratings ($T_{amb} = 25^{\circ}C$)

Symbol	Parameter	Value	Unit
V_{PP}	ESD discharge IEC 61000-4-2, air discharge ESD discharge IEC 61000-4-2, contact discharge	15 8	kV
P_{PP}	Peak pulse power dissipation (8/20 μ s)	60	W
T_j	Maximum junction temperature	125	$^{\circ}C$
T_{op}	Operating temperature range	-30 to + 85	$^{\circ}C$
T_{stg}	Storage temperature range	-55 to +150	$^{\circ}C$

Table 2. Electrical characteristics ($T_{amb} = 25^{\circ}C$)

Symbol	Parameter
V_{BR}	Breakdown voltage
I_{RM}	Leakage current @ V_{RM}
V_{RM}	Stand-off voltage
V_{CL}	Clamping voltage
R_d	Dynamic impedance
I_{PP}	Peak pulse current
αT	Voltage temperature coefficient
V_F	Forward voltage drop

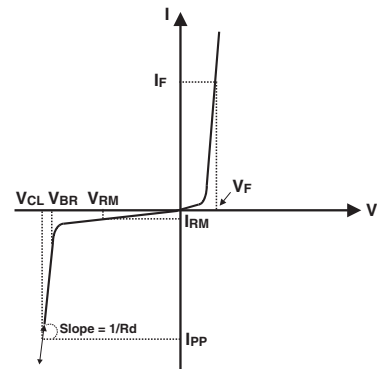

Symbol	Test conditions	Min.	Typ.	Max.	Unit
V_{BR}	$I_R = 1\text{ mA}$	6		9	V
I_{RM}	$V_{RM} = 3\text{ V}$			100	nA
R_d	Exponential wave form 8/20 μ s, $I_{pp} = 1\text{ to }5\text{ A}$		1.6		Ω
αT	$I_R = 1\text{ mA}$			5	$10^{-4}/^{\circ}C$
C_{line}	$V_{LINE} = 0\text{ V}$, $V_{OSC} = 30\text{ mV}$, $F = 1\text{ MHz}$			1.2	pF

Figure 1. Application diagram

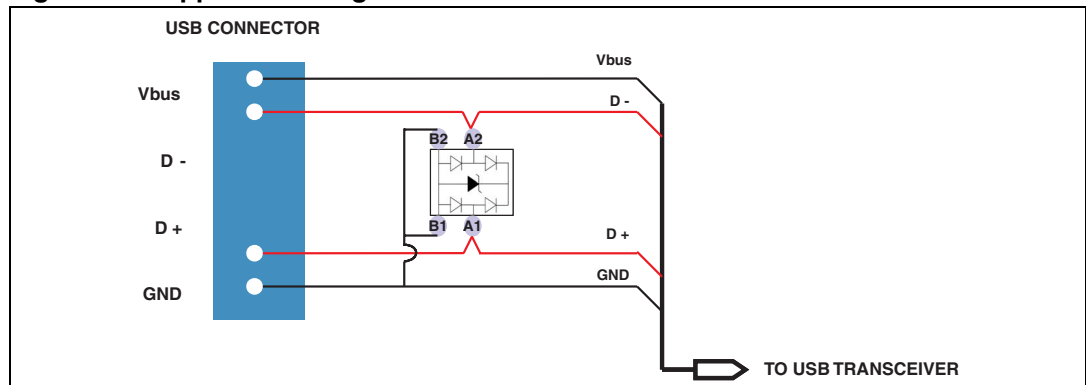

Figure 2. Eye diagram, board only (according to USB High Speed)

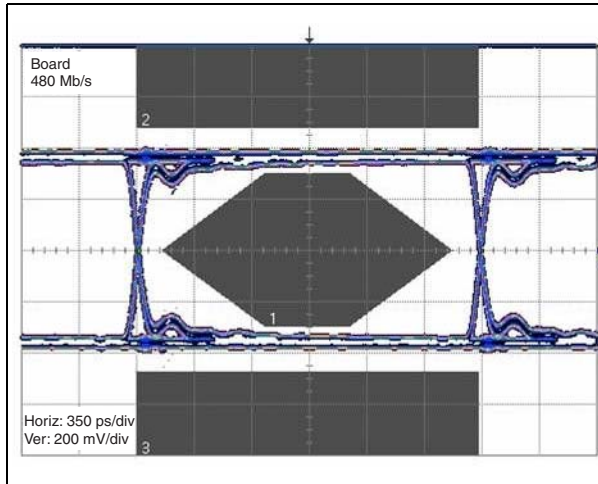

Figure 3. Eye diagram, board with USBULC6-2F3 (according to USB 2.0 High Speed)

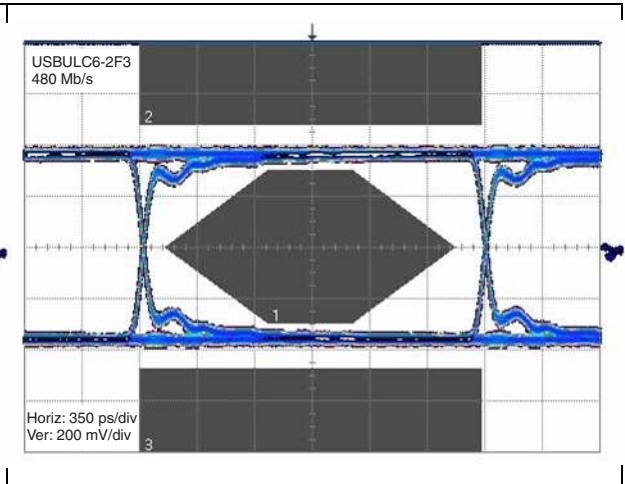

Figure 4. ESD response to IEC 61000-4-2 (+15 kV air discharge)

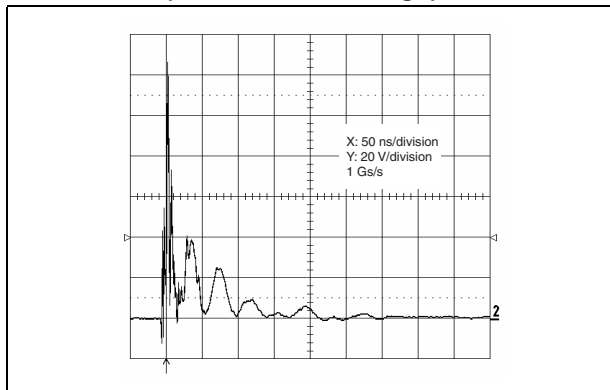

Figure 5. ESD response to IEC 61000-4-2 (-15 kV air discharge)

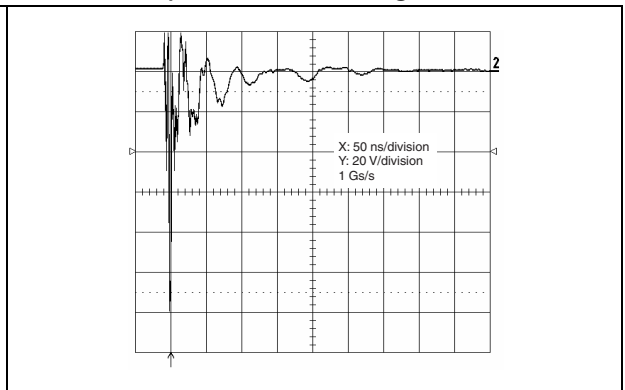

Figure 6. Junction capacitance versus frequency (typical values)

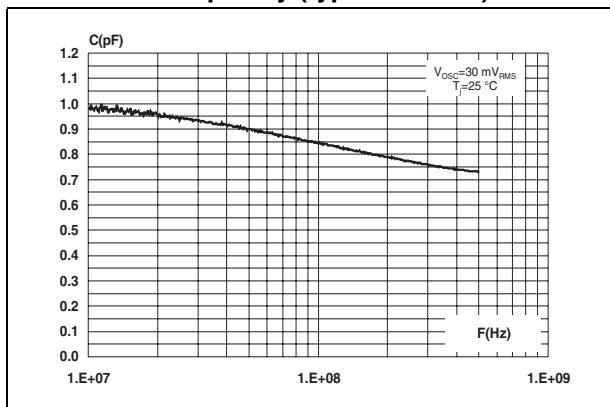

Figure 7. Analog crosstalk measurements

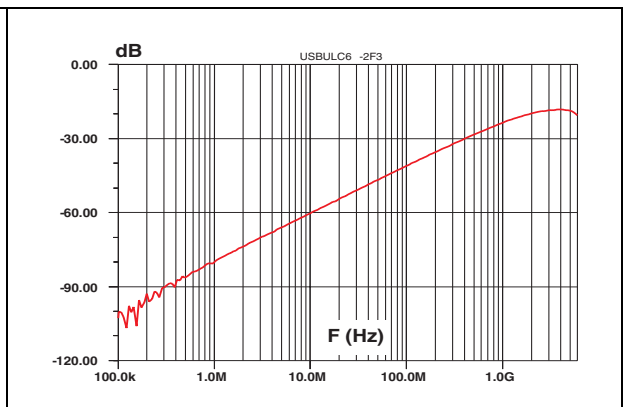

Figure 8. S21 (dB) attenuation measurements

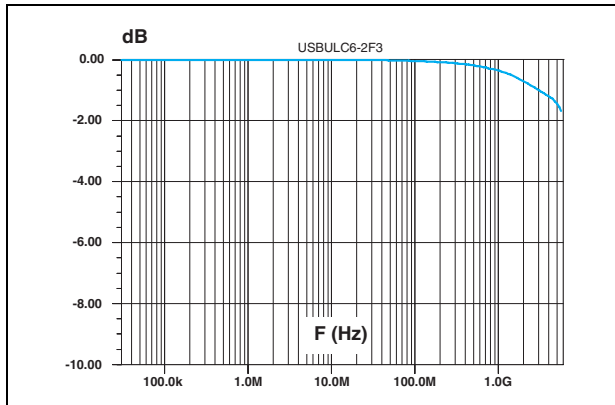

Figure 9. Digital crosstalk

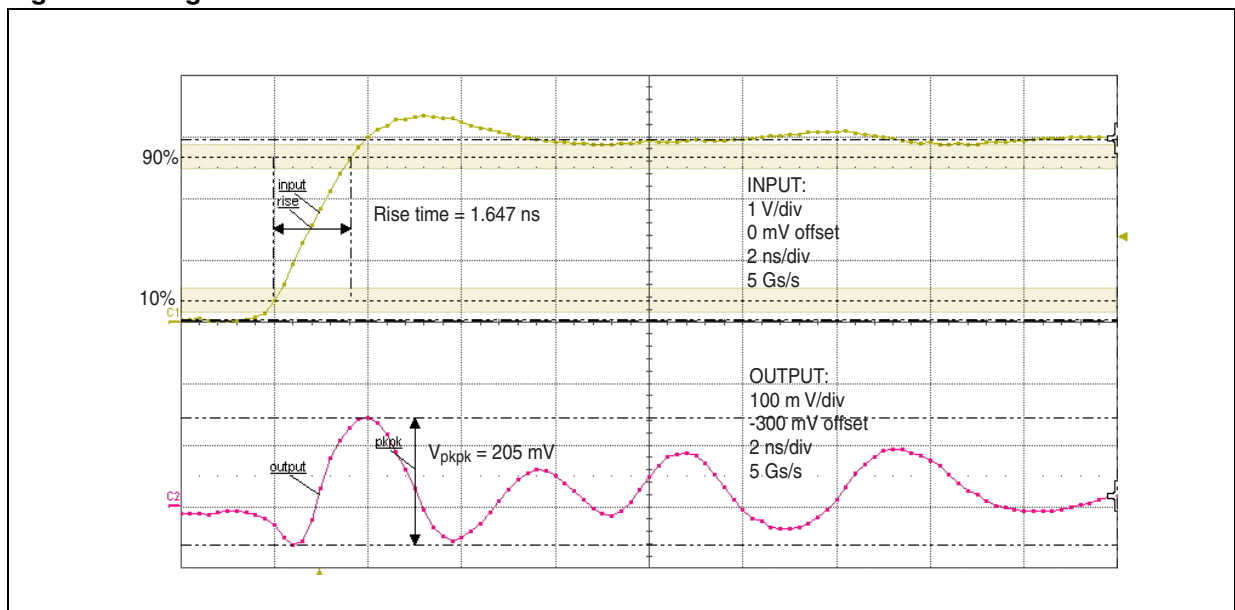

Figure 10. Relative variation of peak pulse power versus initial junction temperature

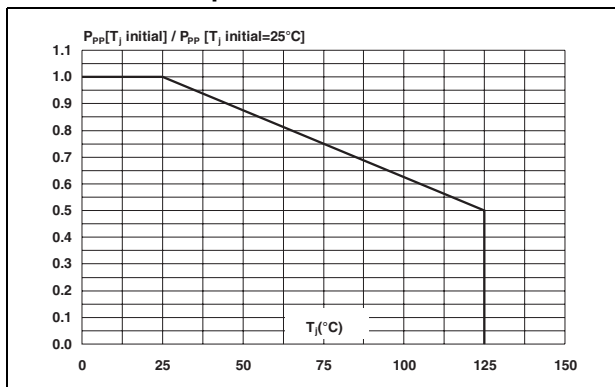

Figure 11. Peak pulse power versus exponential pulse duration

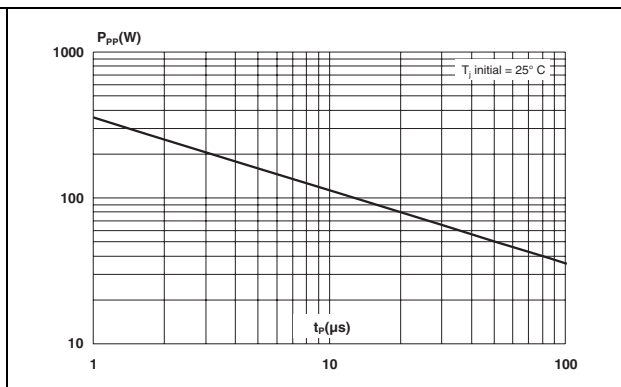

Figure 12. Clamping voltage versus peak pulse current (typical values, exponential waveform)

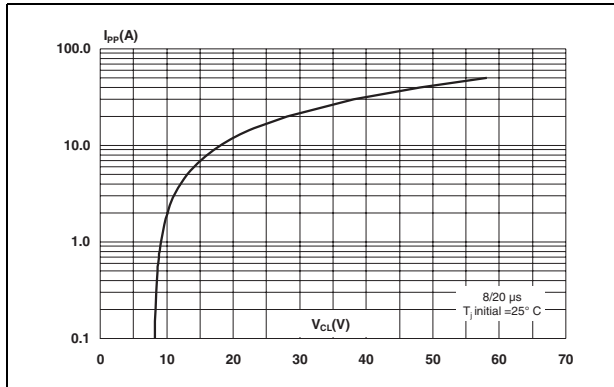
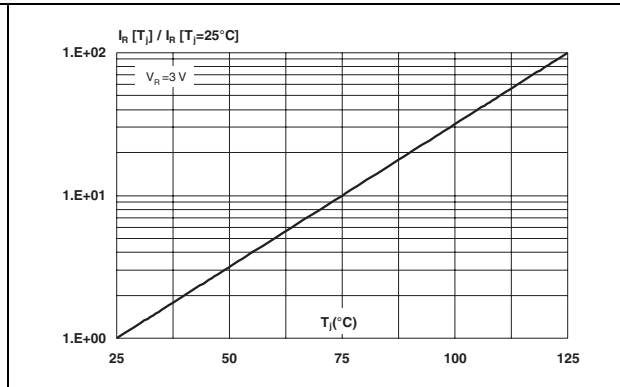
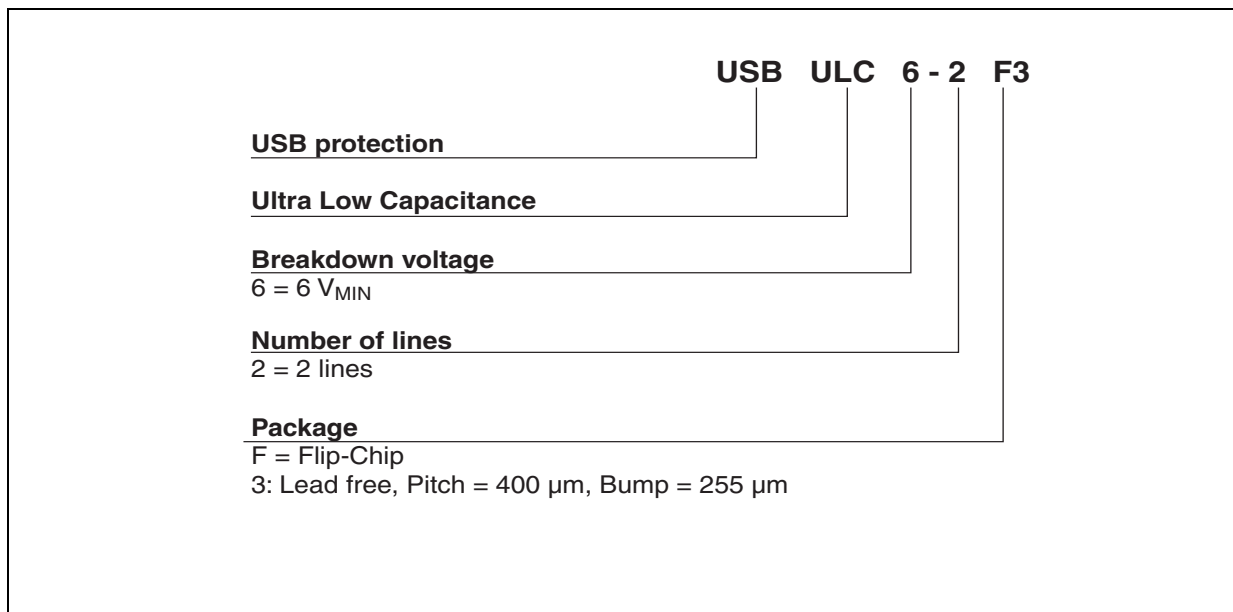

Figure 13. Relative variation of leakage current versus junction temperature (typical values)



2 Ordering information scheme



3 Package information

Figure 14. Flip-Chip dimensions

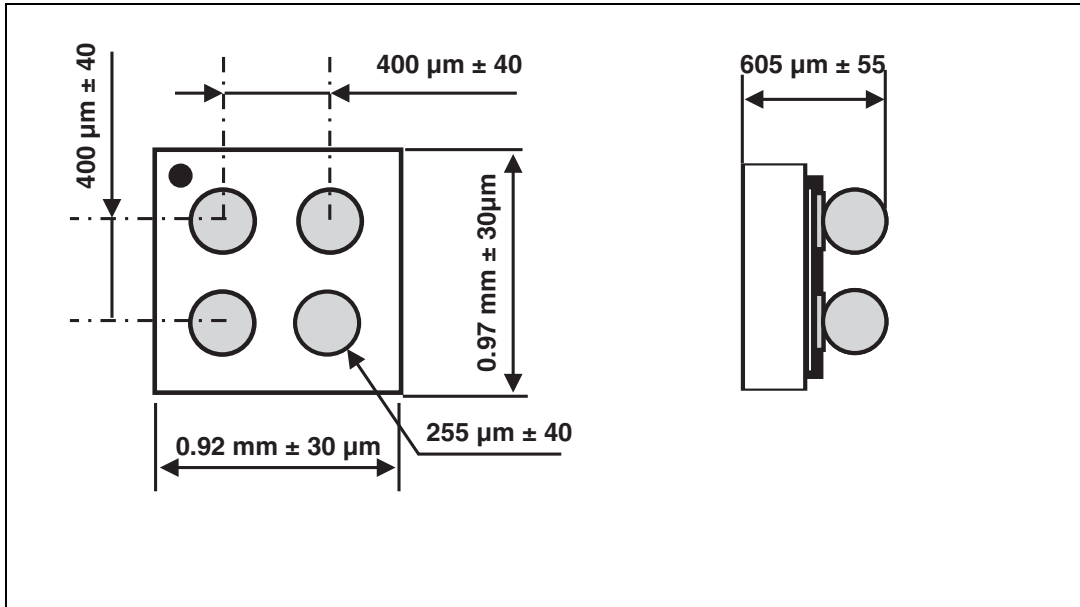

Figure 15. Foot print recommendations Figure 16. Marking

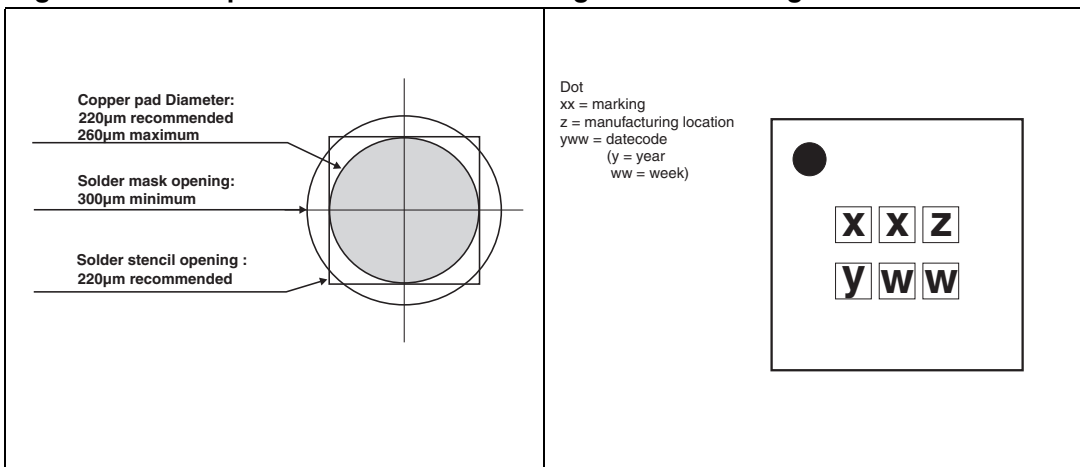
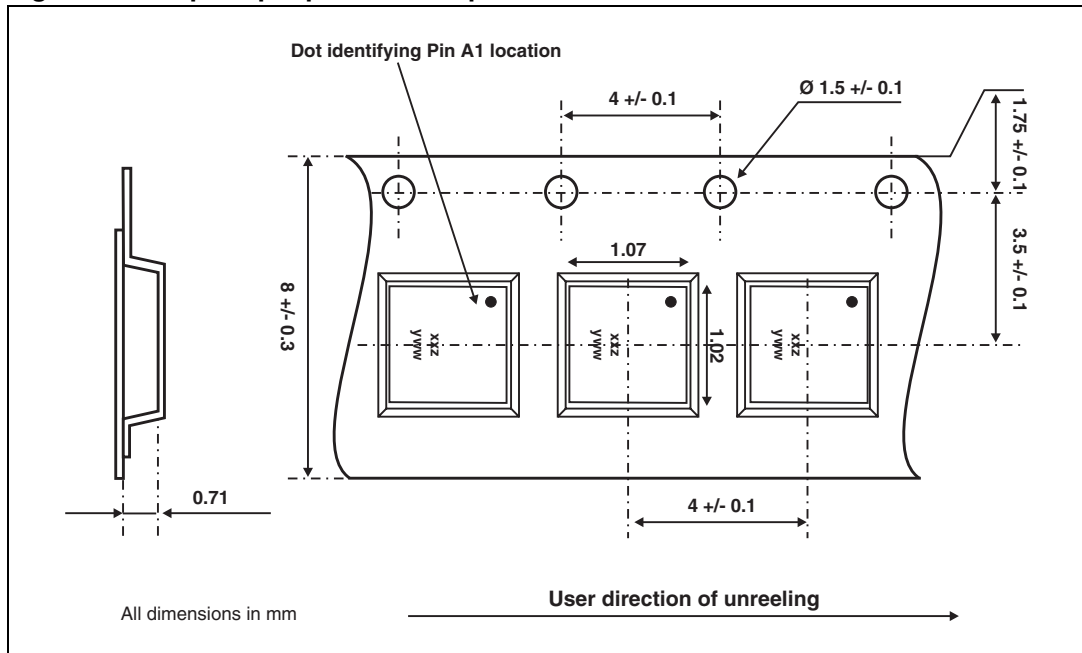

Figure 17. Flip-Chip tape and reel specifications



In order to meet environmental requirements, ST offers these devices in ECOPACK® packages. These packages have a lead-free second level interconnect. The category of second level interconnect is marked on the inner box label, in compliance with JEDEC Standard JESD97. The maximum ratings related to soldering conditions are also marked on the inner box label. ECOPACK is an ST trademark. ECOPACK specifications are available at: www.st.com.

Note: More information is available in the application notes:
 AN2348: "400 μm Flip-Chip: Package description and recommendations for use"
 AN1751: "EMI Filters: Recommendations and measurements"

4 Ordering information

Part Number	Marking	Package	Weight	Base qty	Delivery mode
USBULC6-2F3	EH	Flip-Chip	1.16 mg	5000	Tape and reel (7")

5 Revision history

Date	Revision	Changes
15-Dec-2006	1	Initial release

Please Read Carefully:

Information in this document is provided solely in connection with ST products. STMicroelectronics NV and its subsidiaries ("ST") reserve the right to make changes, corrections, modifications or improvements, to this document, and the products and services described herein at any time, without notice.

All ST products are sold pursuant to ST's terms and conditions of sale.

Purchasers are solely responsible for the choice, selection and use of the ST products and services described herein, and ST assumes no liability whatsoever relating to the choice, selection or use of the ST products and services described herein.

No license, express or implied, by estoppel or otherwise, to any intellectual property rights is granted under this document. If any part of this document refers to any third party products or services it shall not be deemed a license grant by ST for the use of such third party products or services, or any intellectual property contained therein or considered as a warranty covering the use in any manner whatsoever of such third party products or services or any intellectual property contained therein.

UNLESS OTHERWISE SET FORTH IN ST'S TERMS AND CONDITIONS OF SALE ST DISCLAIMS ANY EXPRESS OR IMPLIED WARRANTY WITH RESPECT TO THE USE AND/OR SALE OF ST PRODUCTS INCLUDING WITHOUT LIMITATION IMPLIED WARRANTIES OF MERCHANTABILITY, FITNESS FOR A PARTICULAR PURPOSE (AND THEIR EQUIVALENTS UNDER THE LAWS OF ANY JURISDICTION), OR INFRINGEMENT OF ANY PATENT, COPYRIGHT OR OTHER INTELLECTUAL PROPERTY RIGHT.

UNLESS EXPRESSLY APPROVED IN WRITING BY AN AUTHORIZED ST REPRESENTATIVE, ST PRODUCTS ARE NOT RECOMMENDED, AUTHORIZED OR WARRANTED FOR USE IN MILITARY, AIR CRAFT, SPACE, LIFE SAVING, OR LIFE SUSTAINING APPLICATIONS, NOR IN PRODUCTS OR SYSTEMS WHERE FAILURE OR MALFUNCTION MAY RESULT IN PERSONAL INJURY, DEATH, OR SEVERE PROPERTY OR ENVIRONMENTAL DAMAGE. ST PRODUCTS WHICH ARE NOT SPECIFIED AS "AUTOMOTIVE GRADE" MAY ONLY BE USED IN AUTOMOTIVE APPLICATIONS AT USER'S OWN RISK.

Resale of ST products with provisions different from the statements and/or technical features set forth in this document shall immediately void any warranty granted by ST for the ST product or service described herein and shall not create or extend in any manner whatsoever, any liability of ST.

ST and the ST logo are trademarks or registered trademarks of ST in various countries.

Information in this document supersedes and replaces all information previously supplied.

The ST logo is a registered trademark of STMicroelectronics. All other names are the property of their respective owners.

© 2006 STMicroelectronics - All rights reserved

STMicroelectronics group of companies

Australia - Belgium - Brazil - Canada - China - Czech Republic - Finland - France - Germany - Hong Kong - India - Israel - Italy - Japan - Malaysia - Malta - Morocco - Singapore - Spain - Sweden - Switzerland - United Kingdom - United States of America

www.st.com