

RADIATION HARDENED POWER MOSFET THRU-HOLE (T0-204AA/AE) **RAD Hard™ HEXFET®** TECHNOLOGY

IRH7054 60V, N-CHANNEL

Product Summary

Part Number	Radiation Level	RDS(on)	ID
IRH7054	100K Rads (Si)	0.025Ω	45*A
IRH3054	300K Rads (Si)	0.025Ω	45*A
IRH4054	600K Rads (Si)	0.025Ω	45*A
IRH8054	1000K Rads (Si)	0.025Ω	45*A



International Rectifier's RADHard HEXFET® technology provides high performance power MOSFETs for space applications. This technology has over a decade of proven performance and reliability in satellite applications. These devices have been characterized for both Total Dose and Single Event Effects (SEE). The combination of low Rds(on) and low gate charge reduces the power losses in switching applications such as DC to DC converters and motor control. These devices retain all of the well established advantages of MOSFETs such as voltage control, fast switching, ease of paralleling and temperature stability of electrical parameters.

Features:

- Single Event Effect (SEE) Hardened
- Low RDS(on)
- Low Total Gate Charge
- Proton Tolerant
- Simple Drive Requirements
- Ease of Paralleling
- Hermetically Sealed
- Ceramic Package
- Light Weight

Absolute Maximum Ratings

Pre-Irradiation

	Parameter		Units
ID @ VGS = 12V, TC = 25°C	Continuous Drain Current	45*	A
ID @ VGS = 12V, TC = 100°C	Continuous Drain Current	32	
IDM	Pulsed Drain Current ①	210	
PD @ TC = 25°C	Max. Power Dissipation	150	W
	Linear Derating Factor	1.2	W/°C
VGS	Gate-to-Source Voltage	±20	V
EAS	Single Pulse Avalanche Energy ②	500	mJ
IAR	Avalanche Current ①	35	A
EAR	Repetitive Avalanche Energy ①	15	mJ
dv/dt	Peak Diode Recovery dv/dt ③	3.5	V/ns
TJ	Operating Junction	-55 to 150	°C
TSTG	Storage Temperature Range		
	Lead Temperature	300 (0.063 in.(1.6mm) from case for 10s)	
	Weight	11.5 (Typical)	g

For footnotes refer to the last page

*Current is limited by pin diameter

Electrical Characteristics @ T_j = 25°C (Unless Otherwise Specified)

	Parameter	Min	Typ	Max	Units	Test Conditions
BV _{DSS}	Drain-to-Source Breakdown Voltage	60	—	—	V	V _{GS} = 0V, I _D = 1.0mA
ΔBV _{DSS} /ΔT _J	Temperature Coefficient of Breakdown Voltage	—	0.053	—	V/°C	Reference to 25°C, I _D = 1.0mA
R _{DSON}	Static Drain-to-Source On-State Resistance	—	—	0.025	Ω	V _{GS} = 12V, I _D = 32A ④
		—	—	0.028		V _{GS} = 12V, I _D = 45A
V _{GS(th)}	Gate Threshold Voltage	2.0	—	4.0	V	V _{DS} = V _{GS} , I _D = 1.0mA
g _{fs}	Forward Transconductance	12	—	—	S (r)	V _{DS} > 15V, I _{DS} = 35A ④
I _{DSS}	Zero Gate Voltage Drain Current	—	—	25	μA	V _{DS} = 48V, V _{GS} = 0V
		—	—	250		V _{DS} = 48V, V _{GS} = 0V, T _J = 125°C
I _{GSS}	Gate-to-Source Leakage Forward	—	—	100	nA	V _{GS} = 20V
I _{GSS}	Gate-to-Source Leakage Reverse	—	—	-100	nA	V _{GS} = -20V
Q _g	Total Gate Charge	—	—	200	nC	V _{GS} = 12V, I _D = 35A V _{DS} = 30V
Q _{gs}	Gate-to-Source Charge	—	—	60		
Q _{gd}	Gate-to-Drain ('Miller') Charge	—	—	75		
t _{d(on)}	Turn-On Delay Time	—	—	27	ns	V _{DD} = 30V, I _D = 35A V _{GS} = 12V, R _G = 2.35Ω
t _r	Rise Time	—	—	100		
t _{d(off)}	Turn-Off Delay Time	—	—	75		
t _f	Fall Time	—	—	75		
L _S + L _D	Total Inductance	—	10	—	nH	Measured from Drain lead (6mm/0.25in from package) to Source lead (6mm/0.25in. from Package) with Source wires internally bonded from Source Pin to Drain Pad
C _{iss}	Input Capacitance	—	4100	—	pF	V _{GS} = 0V, V _{DS} = 25V f = 1.0MHz
C _{oss}	Output Capacitance	—	2000	—		
C _{rss}	Reverse Transfer Capacitance	—	560	—		

Source-Drain Diode Ratings and Characteristics

	Parameter	Min	Typ	Max	Units	Test Conditions
I _S	Continuous Source Current (Body Diode)	—	—	45	A	T _j = 25°C, I _S = 35A, V _{GS} = 0V ④
I _{SM}	Pulse Source Current (Body Diode) ①	—	—	210		
V _{SD}	Diode Forward Voltage	—	—	1.4	V	T _j = 25°C, I _F = 35A, di/dt ≤ 100A/μs
t _{rr}	Reverse Recovery Time	—	—	280	nS	V _{DD} ≤ 50V ④
Q _{RR}	Reverse Recovery Charge	—	—	2.2	μC	
t _{on}	Forward Turn-On Time	Intrinsic turn-on time is negligible. Turn-on speed is substantially controlled by L _S + L _D .				

Thermal Resistance

	Parameter	Min	Typ	Max	Units	Test Conditions
R _{thJC}	Junction-to-Case	—	—	0.83	°C/W	Typical socket mount
R _{thJA}	Junction-to-Ambient	—	—	30		
R _{thCS}	Case-to-Sink	—	0.12	—		

Note: Corresponding Spice and Saber models are available on the G&S Website.

For footnotes refer to the last page

International Rectifier Radiation Hardened MOSFETs are tested to verify their radiation hardness capability. The hardness assurance program at International Rectifier is comprised of two radiation environments. Every manufacturing lot is tested for total ionizing dose (per notes 5 and 6) using the TO-3 package. Both pre- and post-irradiation performance are tested and specified using the same drive circuitry and test conditions in order to provide a direct comparison.

Table 1. Electrical Characteristics @ Tj = 25°C, Post Total Dose Irradiation ⑤⑥

Parameter	100K Rads (Si) ¹	300 - 1000K Rads (Si) ²		Units	Test Conditions		
		Min	Max			Min	Max
BVDSS	Drain-to-Source Breakdown Voltage	60	—	60	—	V	V _{GS} = 0V, I _D = 1.0mA
V _{GS(th)}	Gate Threshold Voltage	2.0	4.0	1.25	4.5		V _{GS} = V _{DS} , I _D = 1.0mA
I _{GSS}	Gate-to-Source Leakage Forward	—	100	—	100	nA	V _{GS} = 20V
I _{GSS}	Gate-to-Source Leakage Reverse	—	-100	—	-100		V _{GS} = -20 V
I _{DSS}	Zero Gate Voltage Drain Current	—	25	—	50	µA	V _{DS} =48V, V _{GS} =0V
R _{DS(on)}	Static Drain-to-Source ④ On-State Resistance (TO-3)	—	0.027	—	0.027	Ω	V _{GS} = 12V, I _D =45A
R _{DS(on)}	Static Drain-to-Source ④ On-State Resistance (TO-204AE)	—	0.027	—	0.027	Ω	V _{GS} = 12V, I _D =45A
V _{SD}	Diode Forward Voltage ④	—	1.4	—	1.4	V	V _{GS} = 0V, I _S = 35A

1. Part numbers IRH7054,
2. Part number IRH3054, IRH4540 and IRH8054

International Rectifier radiation hardened MOSFETs have been characterized in heavy ion environment for Single Event Effects (SEE). Single Event Effects characterization is illustrated in Fig. a and Table 2.

Table 2. Single Event Effect Safe Operating Area

Ion	LET MeV/(mg/cm ²)	Energy (MeV)	Range (µm)	V _{DS} (V)				
				@V _{GS} =0V	@V _{GS} =5V	@V _{GS} =10V	@V _{GS} =15V	@V _{GS} =20V
I	59.9	345	32.8	60	60	45	40	30
Br	36.8	305	39	40	35	30	25	20

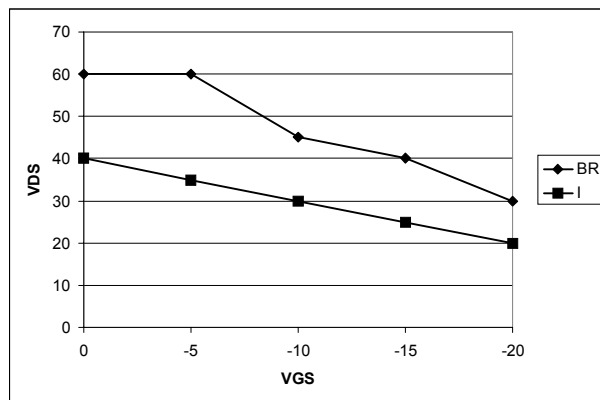

Fig a. Single Event Effect, Safe Operating Area

For footnotes refer to the last page

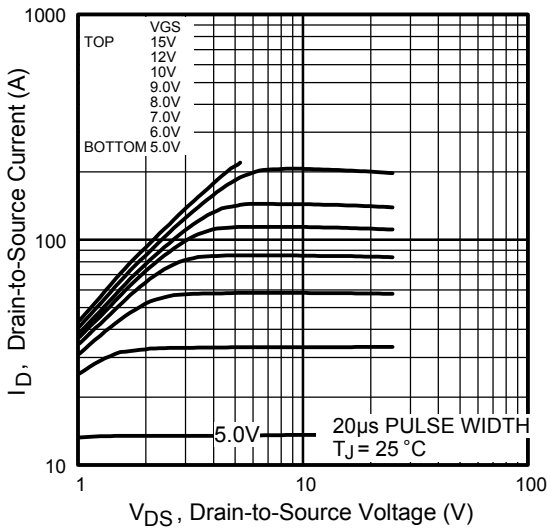

Fig 1. Typical Output Characteristics

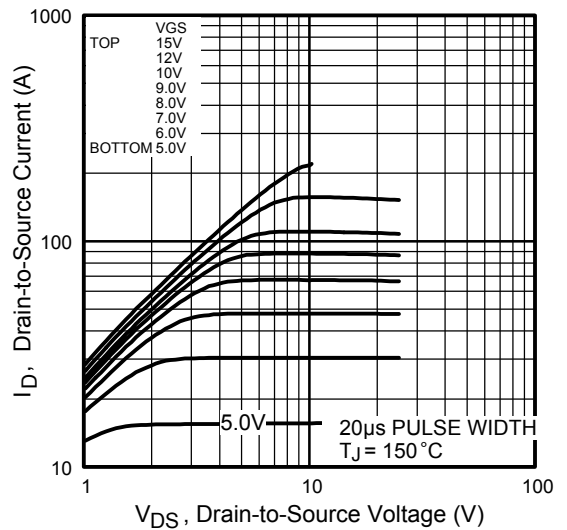

Fig 2. Typical Output Characteristics

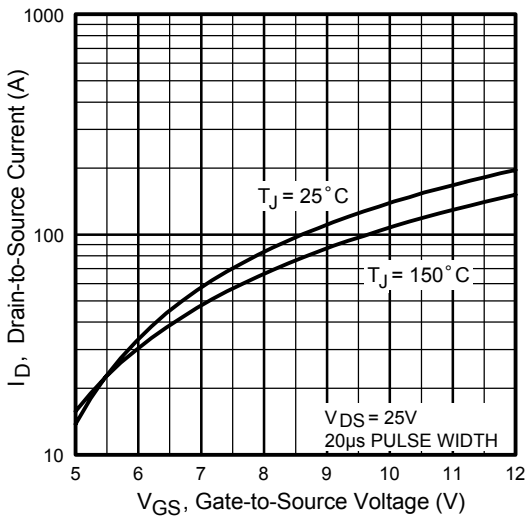

Fig 3. Typical Transfer Characteristics

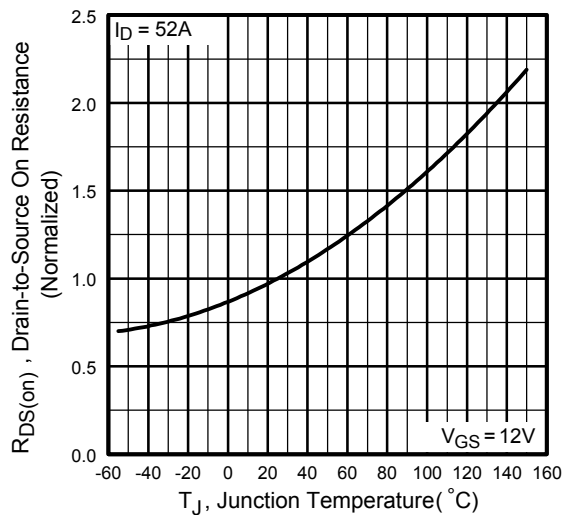

Fig 4. Normalized On-Resistance Vs. Temperature

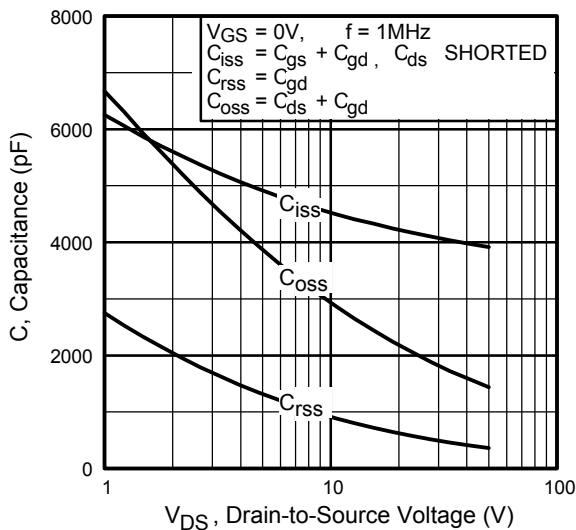

Fig 5. Typical Capacitance Vs. Drain-to-Source Voltage

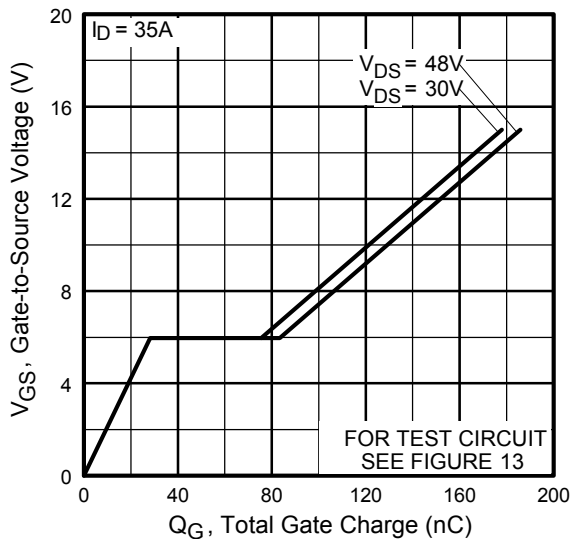

Fig 6. Typical Gate Charge Vs. Gate-to-Source Voltage

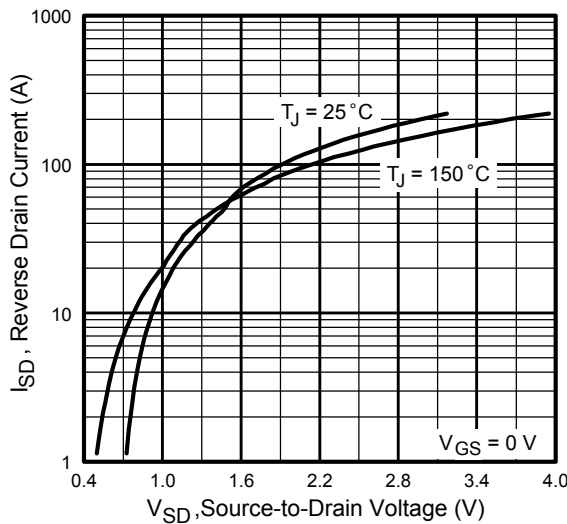

Fig 7. Typical Source-Drain Diode Forward Voltage

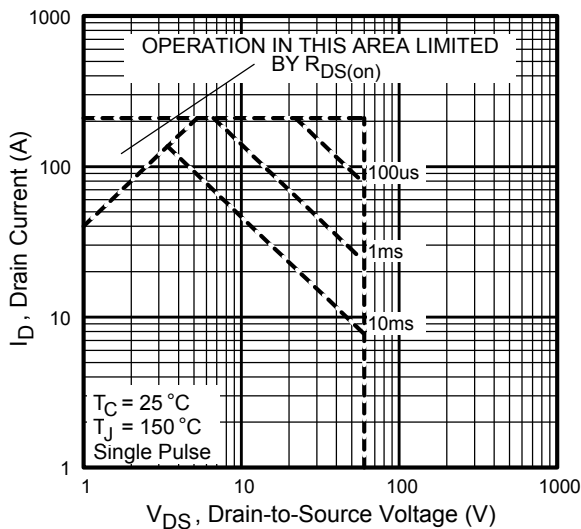

Fig 8. Maximum Safe Operating Area

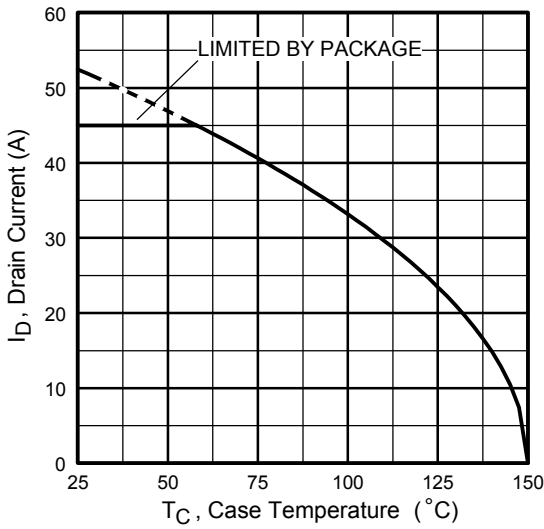

Fig 9. Maximum Drain Current Vs. Case Temperature

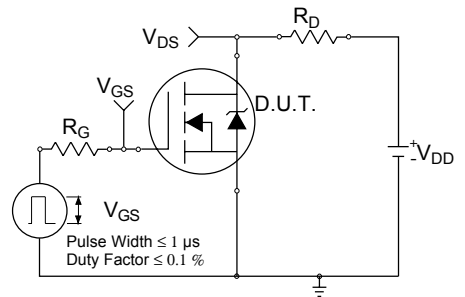

Fig 10a. Switching Time Test Circuit

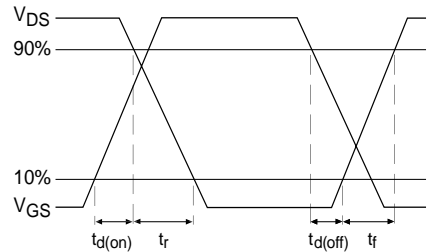

Fig 10b. Switching Time Waveforms

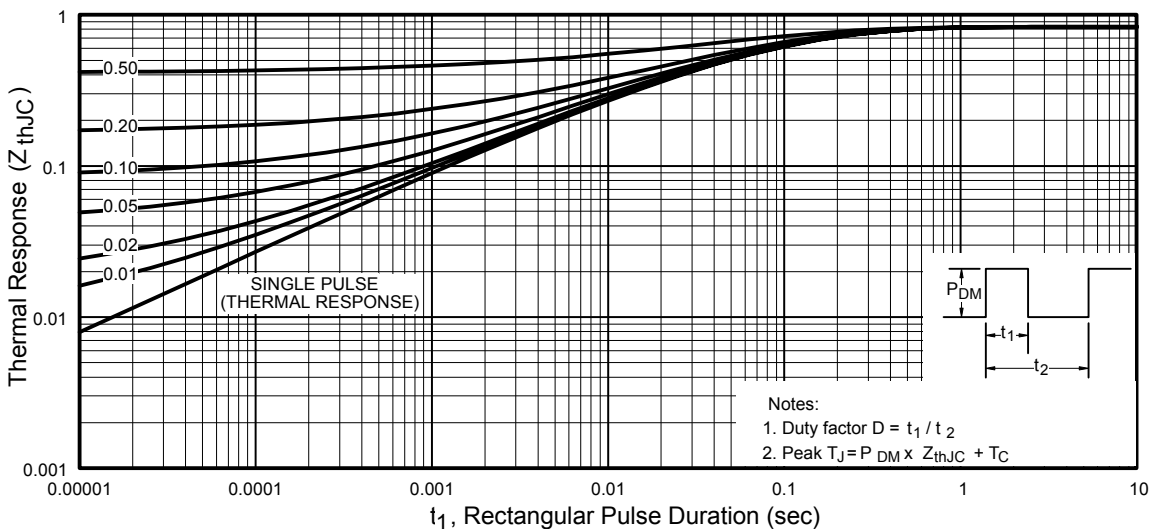

Fig 11. Maximum Effective Transient Thermal Impedance, Junction-to-Case

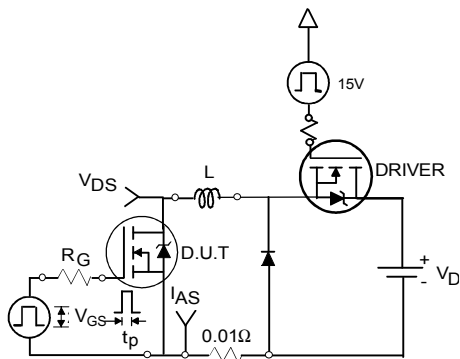

Fig 12a. Unclamped Inductive Test Circuit

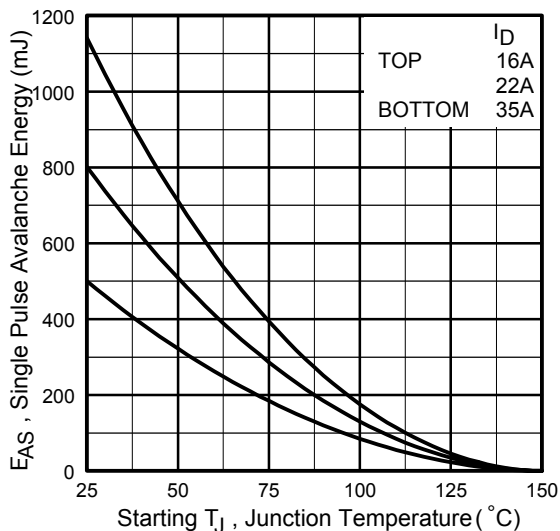

Fig 12c. Maximum Avalanche Energy Vs. Drain Current

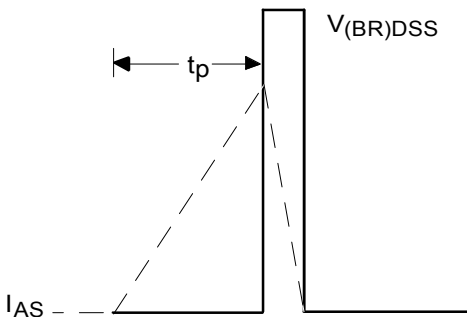

Fig 12b. Unclamped Inductive Waveforms

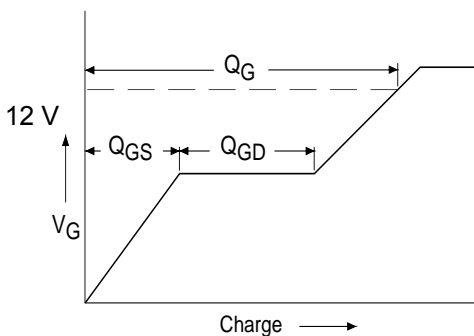

Fig 13a. Basic Gate Charge Waveform

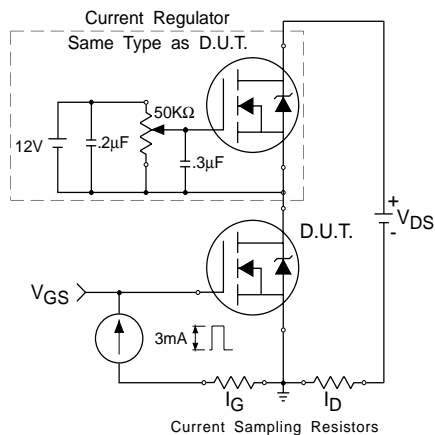
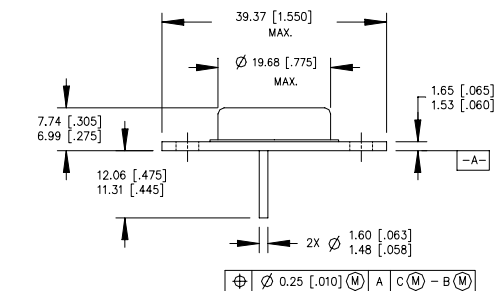

Fig 13b. Gate Charge Test Circuit

Foot Notes:

- ① Repetitive Rating; Pulse width limited by maximum junction temperature.
- ② $V_{DD} = 25V$, starting $T_J = 25^\circ C$, $L=0.49mH$
Peak $I_L = 35A$, $V_{GS} = 12V$
- ③ $I_{SD} \leq 35A$, $di/dt \leq 150A/\mu s$,
 $V_{DD} \leq 60V$, $T_J \leq 150^\circ C$
- ④ Pulse width $\leq 300 \mu s$; Duty Cycle $\leq 2\%$
- ⑤ **Total Dose Irradiation with V_{GS} Bias.**
12 volt V_{GS} applied and $V_{DS} = 0$ during irradiation per MIL-STD-750, method 1019, condition A.
- ⑥ **Total Dose Irradiation with V_{DS} Bias.**
48 volt V_{DS} applied and $V_{GS} = 0$ during irradiation per MIL-STD-750, method 1019, condition A.

Case Outline and Dimensions — TO-204AE



PIN ASSIGNMENTS

- 1 - SOURCE
- 2 - GATE
- 3 - DRAIN (CASE)

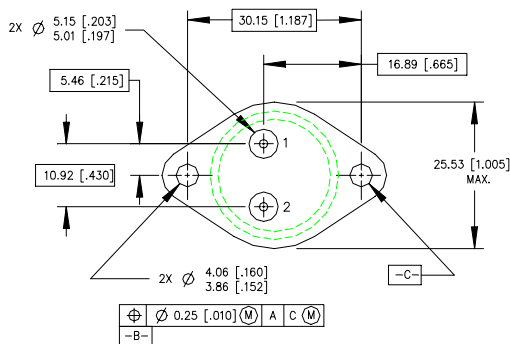

NOTES:

1. DIMENSIONING & TOLERANCING PER ANSI Y14.5M-1982.
2. CONTROLLING DIMENSION: INCH.
3. DIMENSIONS ARE SHOWN IN MILLIMETERS [INCHES].
4. OUTLINE CONFORMS TO JEDEC OUTLINE TO-204AE.



IR WORLD HEADQUARTERS: 233 Kansas St., El Segundo, California 90245, USA Tel: (310) 252-7105
TAC Fax: (310) 252-7903

Visit us at www.irf.com for sales contact information.
Data and specifications subject to change without notice. 08/01