



M.S.KENNEDY CORP.

# VERY HIGH CURRENT, LOW DROPOUT VOLTAGE REGULATORS

# 5150 SERIES

4707 Dey Road Liverpool, N.Y. 13088

(315) 701-6751

### FEATURES:

- Electrically Isolated Top Tab or Z Tab SIP
- Extremely Low Dropout Voltage: 370mV @ 5 Amps
- Available in 3.3V, 5.0V, 12.0V and Adjustable Versions
- Open Collector Error Flag Output
- TTL Level Enable Pin: Zero Current Shutdown Mode
- Reverse Battery and Load Dump Protection
- Low Ground Current: 70mA Typical at Full Load
- 1% Maximum Guaranteed Accuracy
- Output Current to 5 Amps
- Contact MSK for MIL-PRF-38534 Qualification Status

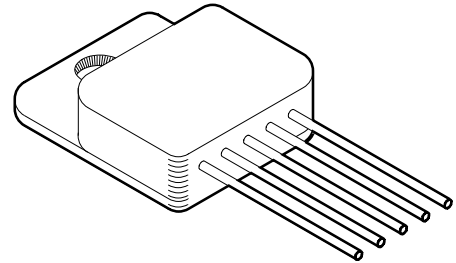

### DESCRIPTION:

The MSK 5150 series voltage regulators are available in +3.3V, +5.0V, +12.0V or adjustable output configurations. All boast ultra low dropout specifications due to the utilization of a super PNP output pass transistor with monolithic technology. Dropout voltages of 370mV at 5 amps are typical in this configuration, which drives efficiency up and power dissipation down. Accuracy is guaranteed with a 1% maximum output voltage tolerance. The series also offers a TTL/CMOS compatible on/off enable function as well as an output flag pin. The MSK 5150 series is packaged in a space efficient 5 pin power SIP available in two styles with three lead bend options.

### EQUIVALENT SCHEMATIC

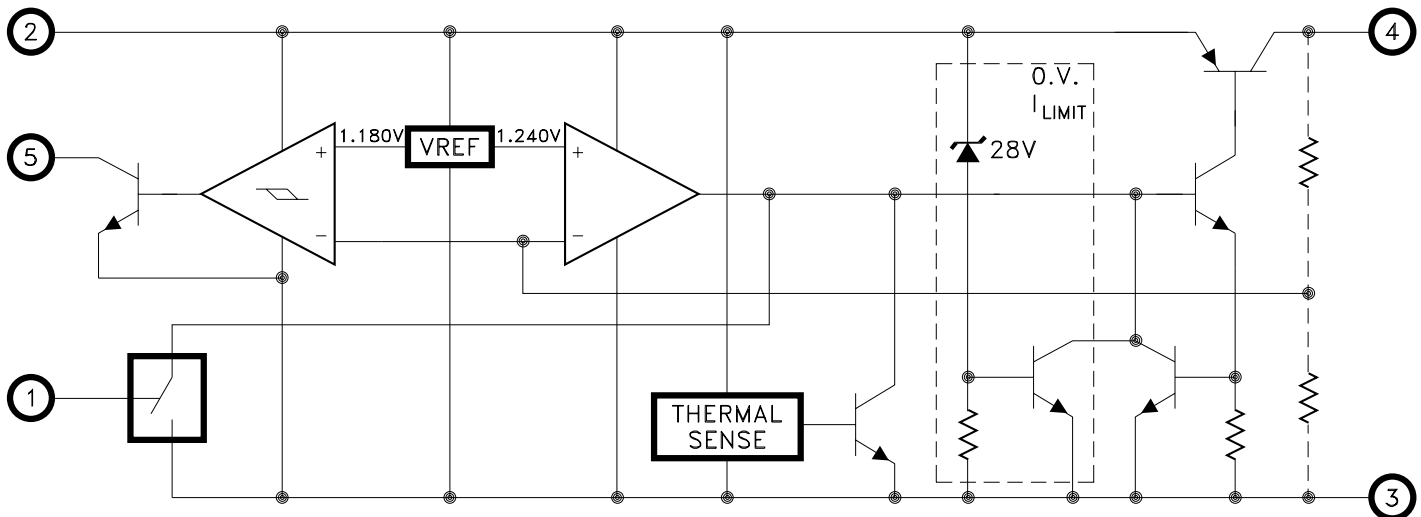

Schematic shown for fixed output voltage versions

### TYPICAL APPLICATIONS

- High Efficiency, Very High Current Linear Regulators
- Constant Voltage/Current Regulators
- System Power Supplies
- Switching Power Supply Post Regulators
- Battery Powered Equipment

### PIN-OUT INFORMATION

MSK5150-00	MSK5150-3.3,-5.0,-12
1 Enable	1 Enable
2 Vin	2 Vin
3 Ground	3 Ground
4 Vout	4 Vout
5 Adjust	5 Flag

## ABSOLUTE MAXIMUM RATINGS

⑪

$V_{INP}$  Input Voltage (100mS 1%D.C.) -20V to +60V  
 $V_{IN}$  Input Voltage . . . . . 26V  
 $V_{EN}$  Enable Voltage . . . . . -0.3V to 26V  
 $I_{OUT}$  Output Current . . . . . 5.5A

$T_{ST}$  Storage Temperature Range -65°C to +150°C  
 $T_{LD}$  Lead Temperature . . . . . 300°C  
 (10 Seconds Soldering)  
 $T_J$  Operating Temperature  
 MSK 5150 Series . . . . . -40°C to +85°C  
 MSK 5150B/E Series . . . . . -55°C to +125°C

## ELECTRICAL SPECIFICATIONS

Parameter	Test Conditions ① ③	Group A Subgroup	MSK 5150B/E SERIES			MSK 5150 SERIES			Units
			Min.	Typ.	Max.	Min.	Typ.	Max.	
Output Voltage Tolerance	$I_{OUT} = 10mA$ ; $V_{IN} = V_{OUT} + 1V$	1	-	$\pm 0.5$	$\pm 1.0$	-	$\pm 0.5$	$\pm 1.0$	%
		2,3	-	$\pm 1.0$	$\pm 2.0$	-	-	-	%
Dropout Voltage	② $\Delta V_{OUT} = -1\%$ ; $I_{OUT} = 250mA$	1	-	125	250	-	125	275	mV
	② $\Delta V_{OUT} = -1\%$ ; $I_{OUT} = 5A$	1	-	370	600	-	370	625	mV
Load Regulation ⑩	$V_{IN} = V_{OUT} + 1V$ $10mA \leq I_{OUT} \leq 4.5A$	1	-	$\pm 0.2$	$\pm 1.0$	-	$\pm 0.2$	$\pm 1.2$	%
		2,3	-	$\pm 0.3$	$\pm 2.0$	-	$\pm 0.3$	-	%
Line Regulation	$(V_{OUT} + 1V) \leq V_{IN} \leq 26V$ $I_{OUT} = 10mA$	1	-	$\pm 0.05$	$\pm 0.5$	-	$\pm 0.05$	$\pm 0.6$	%
		2,3	-	$\pm 0.5$	$\pm 1.0$	-	$\pm 0.5$	-	%
Output Current Limit ②	$V_{OUT} = 0V$ ; $V_{IN} = V_{OUT} + 1V$	-	-	7.5	10	-	7.5	10	A
Ground Current ②	$V_{IN} = V_{OUT} + 1V$ ; $I_{OUT} = 2.5A$	-	-	15	50	-	15	55	mA
	$V_{IN} = V_{OUT} + 1V$ ; $I_{OUT} = 5A$	-	-	70	-	-	70	-	mA
Output Noise ②	$C_L = 20\mu F$ ; $10Hz \leq f \leq 100KHz$	-	-	400	-	-	400	-	$\mu V$
Enable Input Voltage ②	HIGH/ON	1	2.4	1.2	-	2.4	1.2	-	V
		1	-	1.2	0.8	-	1.2	0.8	V
Enable Input Current ②	HIGH/ON	1	-	100	600	-	100	600	$\mu A$
	LOW/OFF	1	-	-	2	-	-	2	$\mu A$
Shutdown Output Current ②	$V_{ENABLE} \leq 0.8V$	-	-	10	500	-	10	500	$\mu A$
Flag Output Leakage ② ⑨	$V_{OH} = 26V$	-	-	0.01	2	-	0.01	2	$\mu A$
Flag Output On Voltage ⑨	$I_{OL} \leq 250\mu A$ ; $V_{IN} = V_{OUT} - 2V$	1	-	0.2	0.4	-	0.2	0.4	V
Flag Threshold ② ⑨	$V_{IN} = V_{OUT} - 7\%$	-	-	75	-	-	75	-	mV
Reference Voltage ⑧	Normal Operation	1	1.22	1.24	1.26	1.22	1.24	1.26	V
Reference Voltage Temp Drift ② ⑧	Normal Operation	-	-	20	-	-	20	-	ppm/°C
Adjust Pin Bias Current ② ⑧	Full Temp; $V_{IN} = V_{OUT} + 1V$	-	-	40	120	-	40	150	nA
Thermal Resistance ②	Junction to Case @125°C	-	-	1.1	1.5	-	1.1	1.7	°C/W
Thermal Shutdown ②	$T_J$	-	-	135	-	-	135	-	°C

### NOTES:

- ① Output decoupled to ground using 28 $\mu F$  minimum capacitance unless otherwise specified.
- ② This parameter is guaranteed by design but need not be tested.  
Typical parameters are representative of actual device performance but are for reference only.
- ③ All output parameters are tested using a low duty cycle pulse to maintain  $T_J = T_C$ .
- ④ Industrial grade and "E" suffix devices shall be tested to subgroup 1 unless otherwise specified.
- ⑤ Military grade devices ('B' suffix) shall be 100% tested to subgroups 1,2 and 3.
- ⑥ Subgroup 1  $T_C = +25^\circ C$   
Subgroup 2  $T_J = +125^\circ C$   
Subgroup 3  $T_A = -55^\circ C$
- ⑦ Please consult the factory if alternate output voltages are required.
- ⑧ Applies to MSK5150-00 adjustable version only.
- ⑨ Applies to fixed output devices only.
- ⑩ Due to current limit, maximum output current may not be available at all values of  $V_{IN}$ - $V_{OUT}$  and temperatures. See typical performance curves for clarification.
- ⑪ Continuous operation at or above absolute maximum ratings may adversely effect the device performance and/or life cycle.

PART NUMBER	OUTPUT VOLTAGE
MSK5150-00	Adjustable
MSK5150-3.3	+3.3V
MSK5150-5.0	+5.0V
MSK5150-12	+12.0V

## APPLICATION NOTES

### REGULATOR PROTECTION:

The MSK 5150 series is fully protected against reversed input polarity, overcurrent faults, overtemperature conditions (Pd) and transient voltage spikes of up to 60V. If the regulator is used in dual supply systems where the load is returned to a negative supply, the output voltage must be diode clamped to ground.

### OUTPUT CAPACITOR:

The output voltage ripple of the MSK 5150 series voltage regulators can be minimized by placing a filter capacitor from the output to ground. The optimum value for this capacitor may vary from one application to the next, but a minimum of 20µF is recommended for optimum performance. This capacitor need not be an expensive low ESR type: aluminum electrolytics are adequate. In fact, extremely low ESR capacitors may contribute to instability. Tantalum capacitors are recommended for systems where fast load transient response is important. Transient load response can also be improved by placing a capacitor directly across the load.

### LOAD CONNECTIONS:

In voltage regulator applications where very large load currents are present, the load connection is very important. The path connecting the output of the regulator to the load must be extremely low impedance to avoid affecting the load regulation specifications. Any impedance in this path will form a voltage divider with the load. The MSK 5150 series requires a minimum of 10mA of load current to stay in regulation.

### ENABLE PIN:

The MSK 5150 series of voltage regulators are equipped with a TTL compatible ENABLE pin. A TTL high level on this pin activates the internal bias circuit and powers up the device. A TTL low level on this pin places the controller in shutdown mode and the device draws approximately 10µA of quiescent current. If the enable function is not used, simply connect the enable pin to the input.

### FLAG OUTPUT PIN:

All of the fixed output voltage versions of the MSK 5150 series are equipped with a flag output pin. Since the flag pin is an open collector configuration it can be pulled up to any voltage between 3V and 26V. This feature allows direct interfacing to practically any logic. This active low output has a typical level of 0.22V when the flag comparator detects an "out of regulation" condition. Flag states include low input voltage, out of regulation and output current limit. Extremely high level input voltage transients will also cause the flag output pin to activate.

### DEVICE/CASE CONNECTION:

The MSK 5150 series are highly thermally conductive devices and the thermal path from the package heat sink to the internal junctions is very short. Since the case is electrically isolated from the internal circuitry, the package can be directly connected to a heat sink.

### HEAT SINK SELECTION:

To select a heat sink for the MSK 5150, the following formula for convective heat flow may be used.

Governing Equation:

$$T_j = P_d \times (R_{\theta jc} + R_{\theta cs} + R_{\theta sa}) + T_a$$

WHERE:

$T_j$  = Junction Temperature

$P_d$  = Total Power Dissipation

$R_{\theta jc}$  = Junction to Case Thermal Resistance

$R_{\theta cs}$  = Case to Heat Sink Thermal Resistance

$R_{\theta sa}$  = Heat Sink to Ambient Thermal Resistance

$T_a$  = Ambient Temperature

First, the power dissipation must be calculated as follows:

$$\text{Power Dissipation} = (V_{in} - V_{out}) \times I_{out}$$

Next, the user must select a maximum junction temperature. The absolute maximum allowable junction temperature is 125°C. The equation may now be rearranged to solve for the required heat sink to ambient thermal resistance ( $R_{\theta sa}$ ).

EXAMPLE:

An MSK 5150-3.3 is configured for  $V_{in} = +5V$  and  $V_{out} = +3.3V$ .  $I_{out}$  is a continuous 1A DC level. The ambient temperature is +25°C. The maximum desired junction temperature is 125°C.

$R_{\theta jc} = 1.5^\circ\text{C/W}$  and  $R_{\theta cs} = 0.15^\circ\text{C/W}$  for most thermal greases

$$\begin{aligned} \text{Power Dissipation} &= (5V - 3.3V) \times (1A) \\ &= 1.7 \text{ Watts} \end{aligned}$$

Solve for  $R_{\theta sa}$ :

$$\begin{aligned} R_{\theta sa} &= \left[ \frac{125^\circ\text{C} - 25^\circ\text{C}}{1.7\text{W}} \right] - 1.5^\circ\text{C/W} - 0.15^\circ\text{C/W} \\ &= 57.17^\circ\text{C/W} \end{aligned}$$

In this example, a heat sink with a thermal resistance of no more than 57°C/W must be used to maintain a junction temperature of no more than 125°C.

### MSK5150-00 OUTPUT ADJUSTMENT:

The MSK 5150-00 is an adjustable version in the series of high performance regulators. The diagram below illustrates proper adjustment technique for the output voltage. The series resistance of  $R_1 + R_2$  should be selected to pass the minimum regulator output current requirement of 10mA.

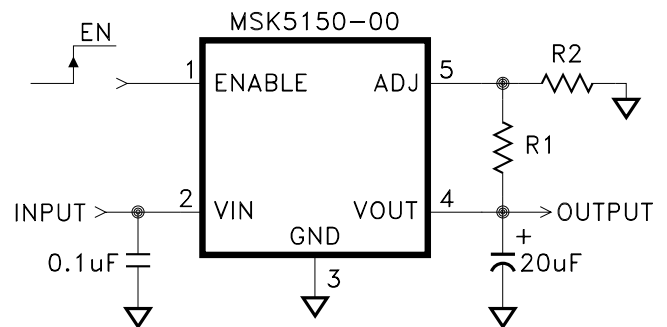

$$V_{OUT} = 1.240V \times \left[ 1 + \left( \frac{R_1}{R_2} \right) \right]$$

# TYPICAL PERFORMANCE CURVES

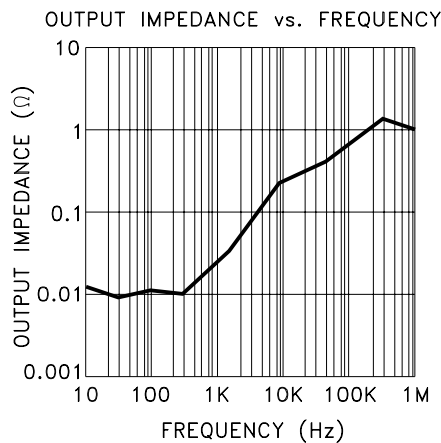
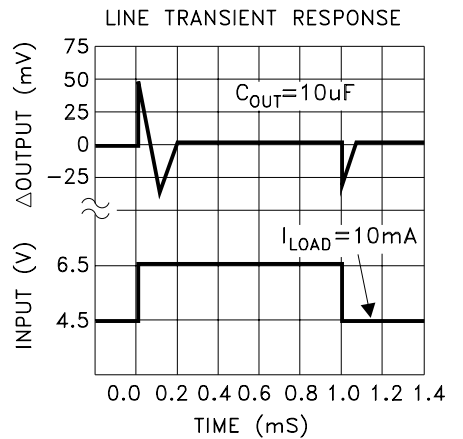
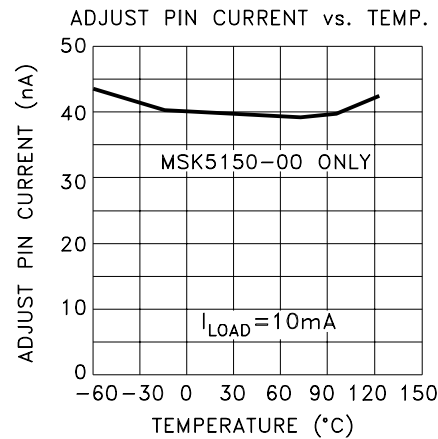
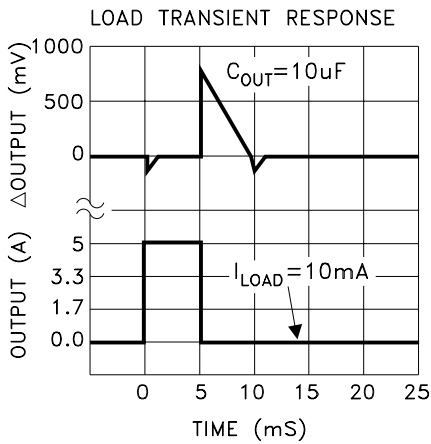
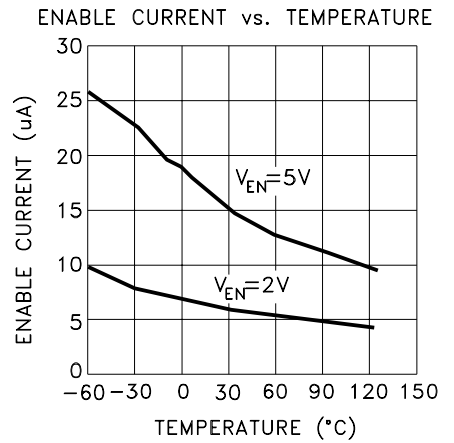
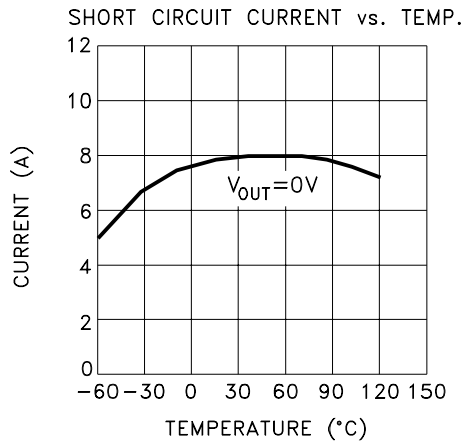
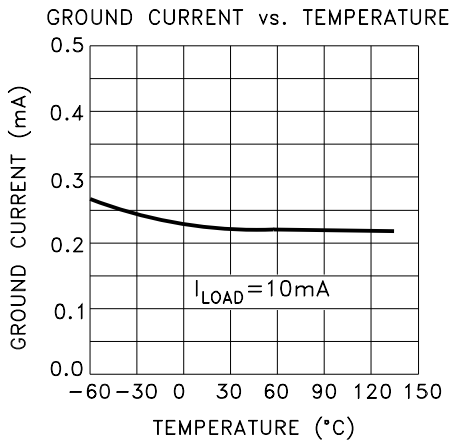
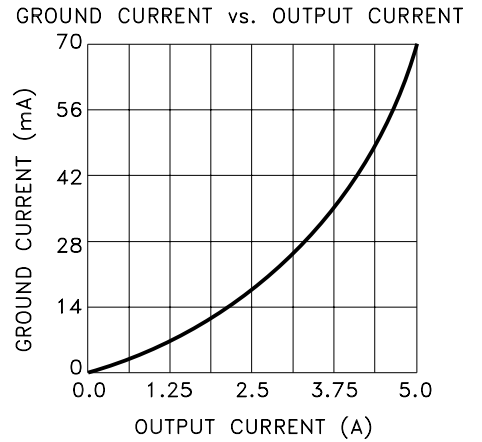
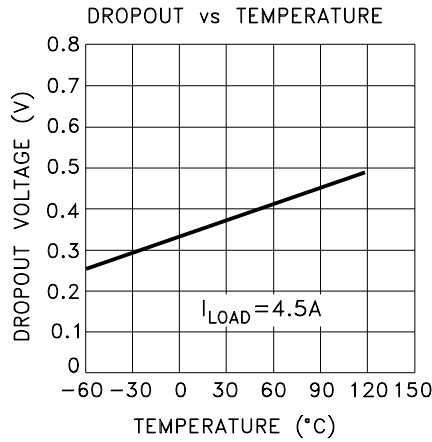
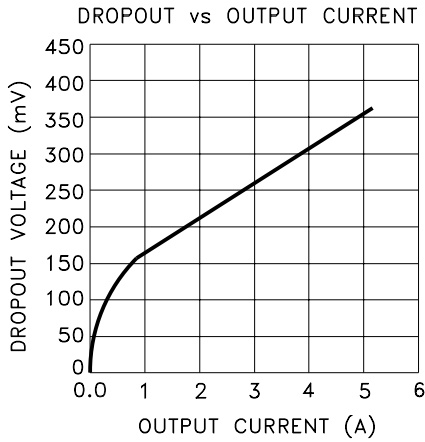

# MECHANICAL SPECIFICATIONS

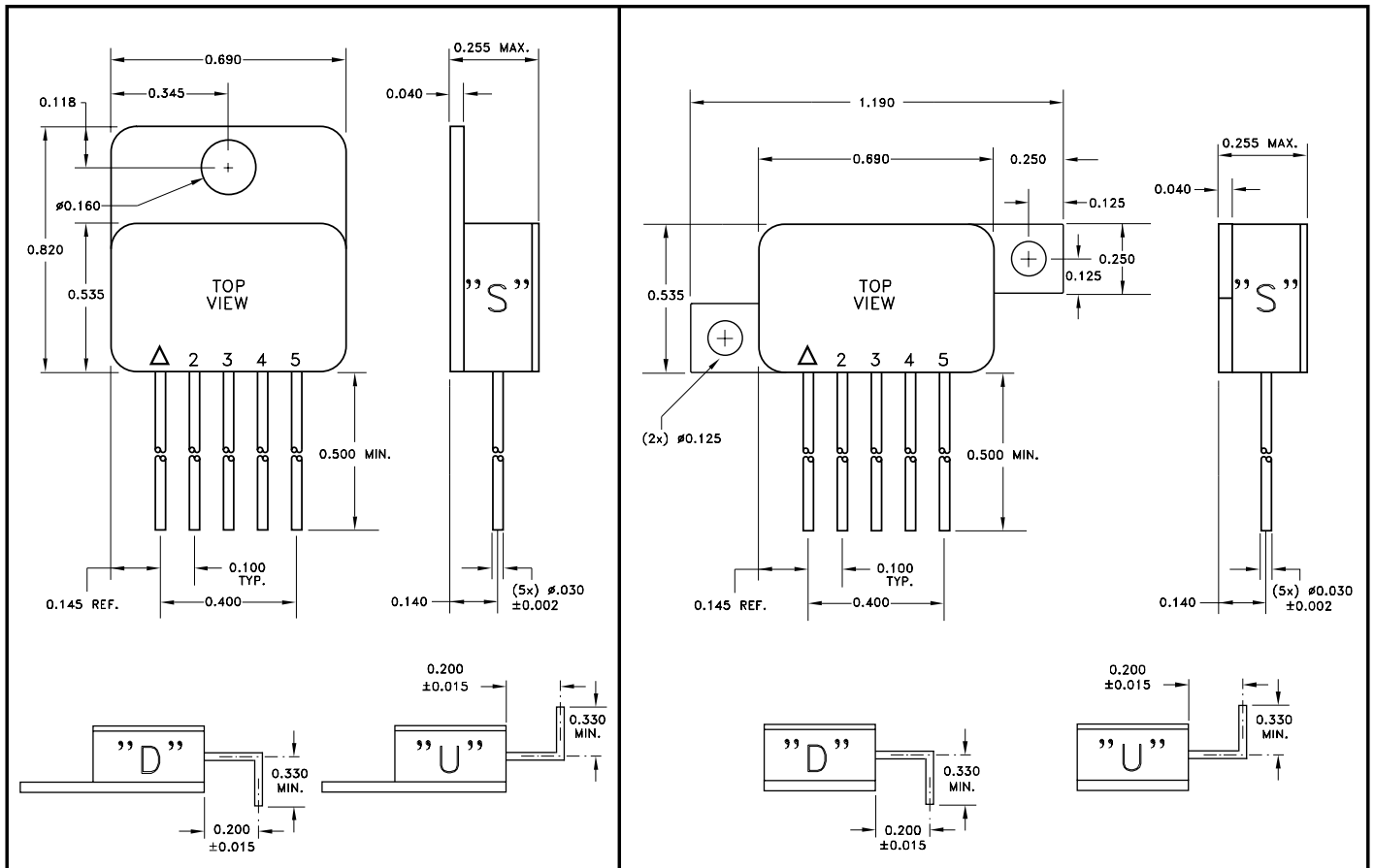

NOTE: ALL DIMENSIONS ARE  $\pm 0.010$  INCHES UNLESS OTHERWISE LABELED.  
ESD Triangle indicates Pin 1.

## ORDERING INFORMATION

**MSK5150-3.3 B T U**

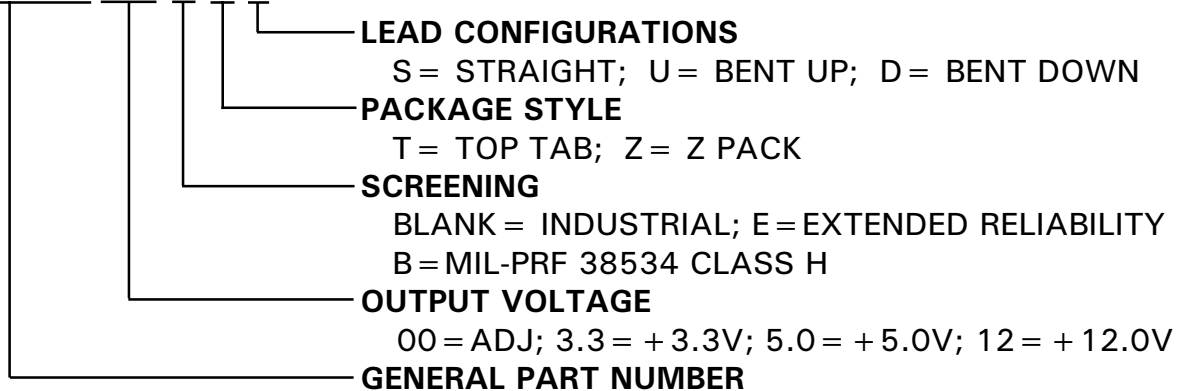

The above example is a + 3.3V, Military regulator using the top tab package with leads bent up.

**M.S. Kennedy Corp.**  
4707 Dey Road, Liverpool, New York 13088  
Phone (315) 701-6751  
FAX (315) 701-6752  
[www.mskennedy.com](http://www.mskennedy.com)

The information contained herein is believed to be accurate at the time of printing. MSK reserves the right to make changes to its products or specifications without notice, however, and assumes no liability for the use of its products.

Please visit our website for the most recent revision of this datasheet.

Contact MSK for MIL-PRF-38534 qualification status.