

NCP2809 Series

NOCAP™ 135 mW Stereo Headphone Power Amplifier

The NCP2809 is a cost-effective stereo audio power amplifier capable of delivering 135 mW of continuous average power per channel into 16 Ω loads.

The NCP2809 audio power amplifier is specifically designed to provide high quality output power from low supply voltage, requiring very few external components. Since NCP2809 does not require bootstrap capacitors or snubber networks, it is optimally suited for low-power portable systems. NCP2809A has an internal gain of 0 dB while specific external gain can externally be set with NCP2809B.

If the application allows it, the virtual ground provided by the device can be connected to the middle point of the headset (Figure 1). In such case, the two external heavy coupling capacitors typically used can be removed. Otherwise, you can also use both outputs in single ended mode with external coupling capacitors (Figure 43).

Due to its excellent Power Supply Rejection Ratio (PSRR), it can be directly connected to the battery, saving the use of an LDO.

Features

- 135 mW to a 16 Ω Load from a 5.0 V Power Supply
- Excellent PSRR (85 dB Typical): Direct Connection to the Battery
- “Pop and Click” Noise Protection Circuit
- Ultra Low Current Shutdown Mode
- 2.2 V–5.5 V Operation
- Outstanding Total Harmonics Distortion + Noise (THD+N): Less than 0.01%
- External Turn-on and Turn-off Configuration Capability
- Thermal Overload Protection Circuitry
- Pb-Free Packages are Available

Typical Applications

- Cellular Phone
- Portable Stereo
- MP3 Player
- Personal and Notebook Computers



ON Semiconductor®

<http://onsemi.com>

MARKING DIAGRAM

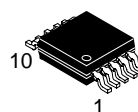

Micro10
DM SUFFIX
CASE 846B

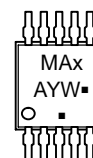

x = E for NCP2809A
C for NCP2809B
A = Assembly Location
Y = Year
W = Work Week
▪ = Pb-Free Package
(Note: Microdot may be in either location)

PIN CONNECTIONS

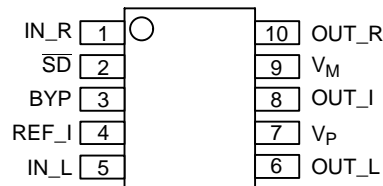

ORDERING INFORMATION

See detailed ordering and shipping information in the package dimensions section on page 20 of this data sheet.

NCP2809 Series

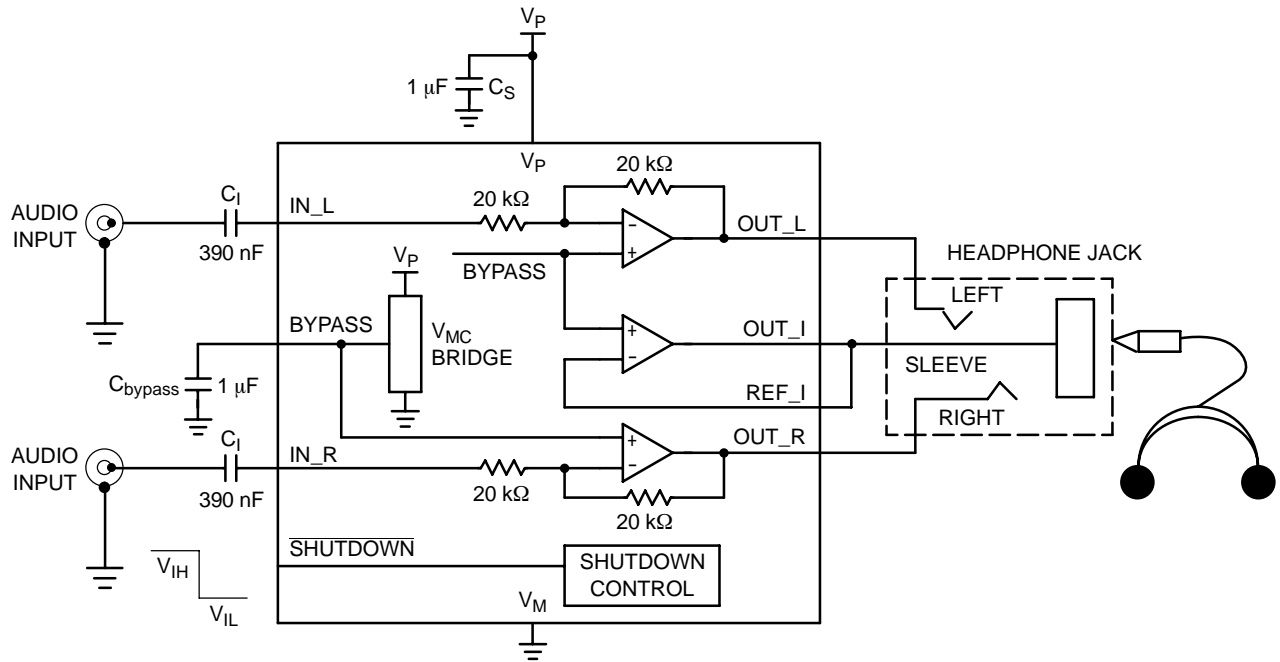

Figure 1. NCP2809A Typical Application Schematic without Output Coupling Capacitor (NOCAP Configuration)

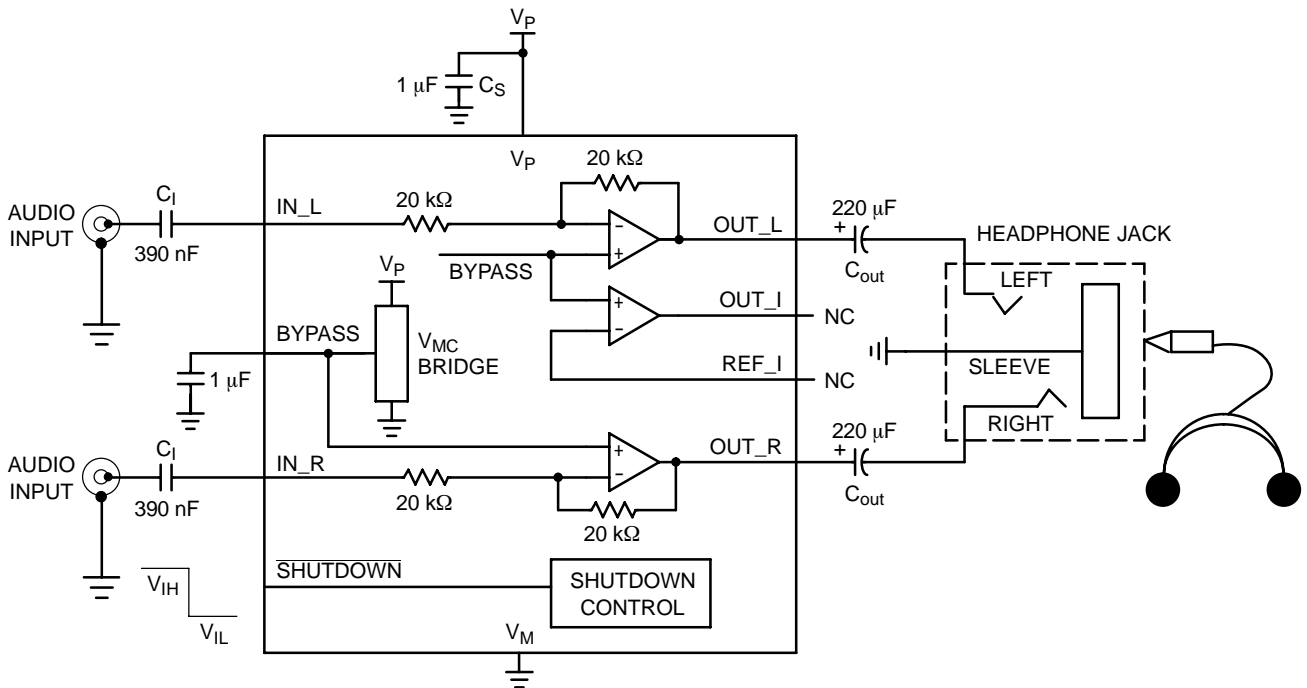

Figure 2. NCP2809A Typical Application Schematic with Output Coupling Capacitor

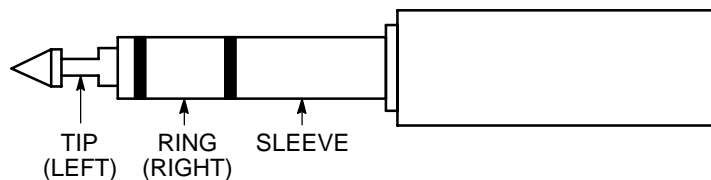

Figure 3. Typical 3-Wire Headphone Plug

NCP2809 Series

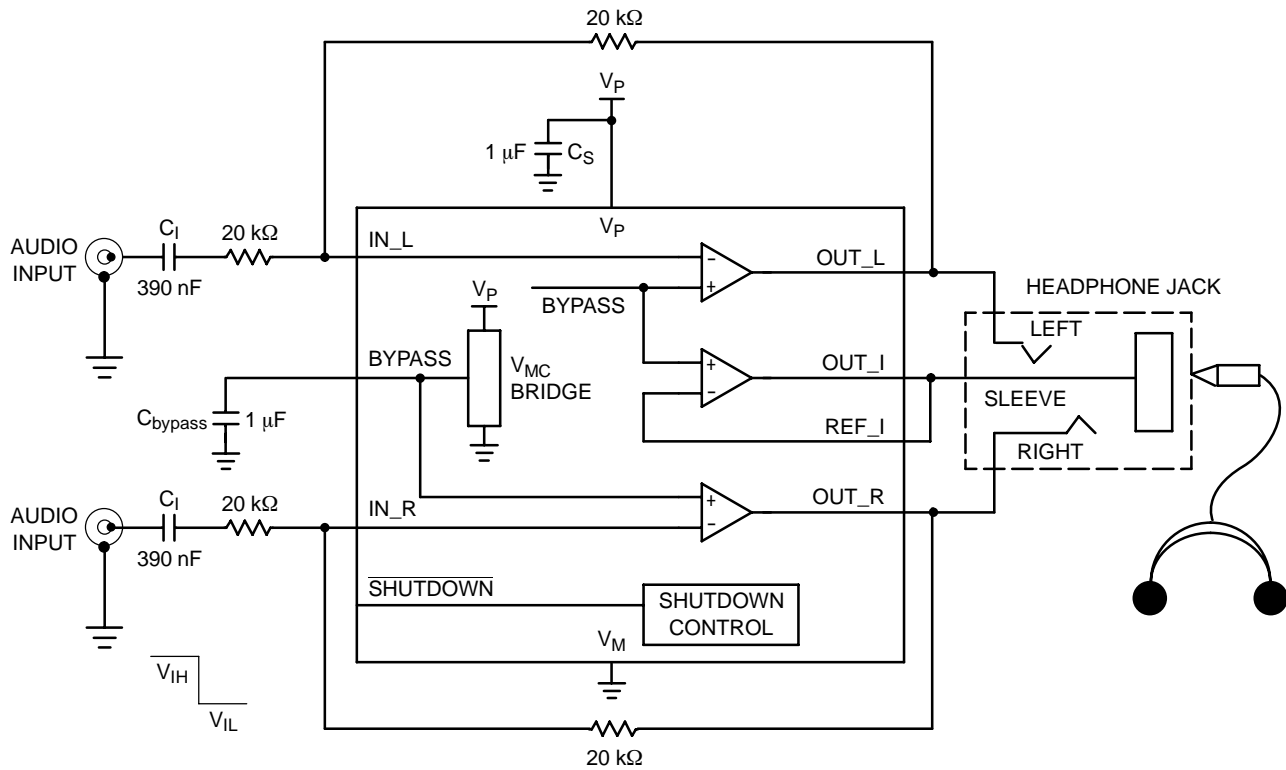

Figure 4. NCP2809B Typical Application Schematic without Output Coupling Capacitor (NOCAP Configuration)

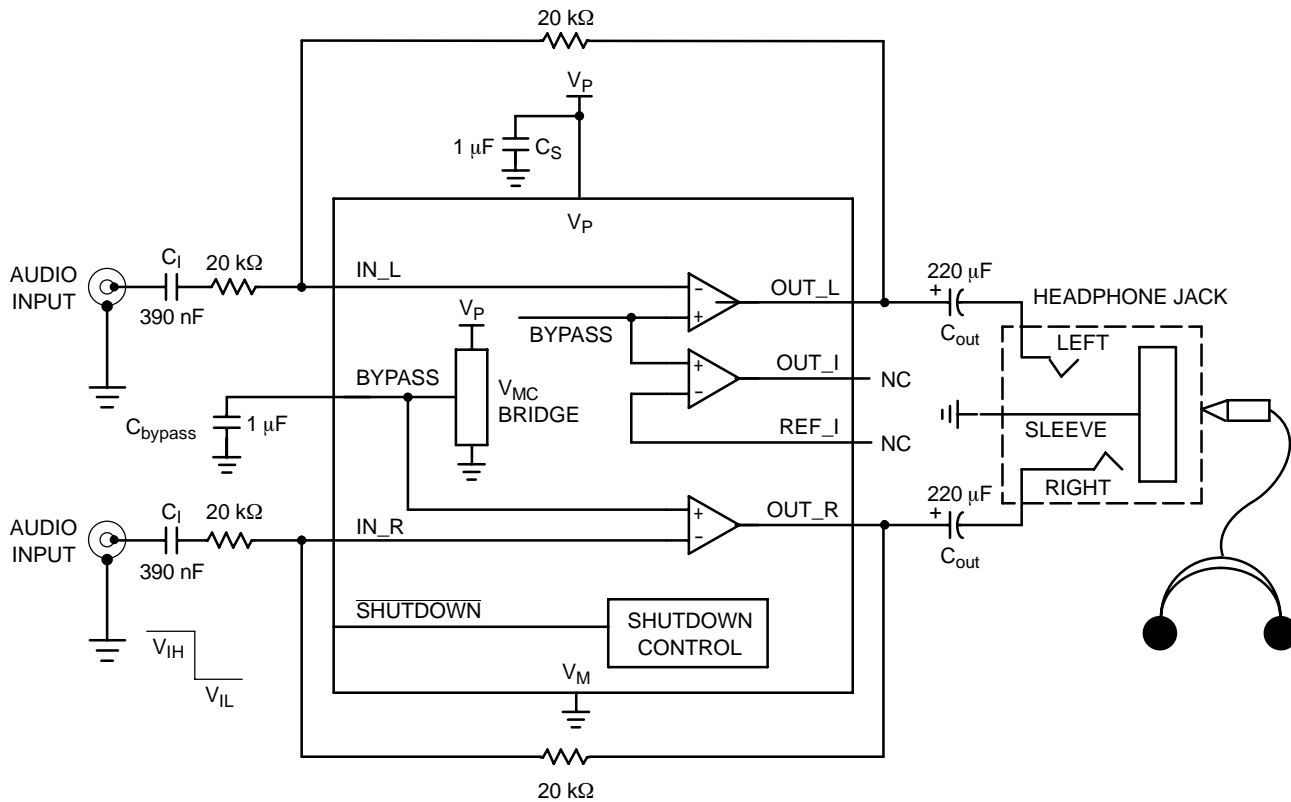

Figure 5. NCP2809B Typical Application Schematic with Output Coupling Capacitor

NCP2809 Series

PIN FUNCTION DESCRIPTION

Pin	Type	Symbol	Description
1	I	IN_R	Negative input of the second amplifier. It receives the audio input signal. Connected to the input capacitor C_{in} (NCP2809A) or the external R_{in} (NCP2809B).
2	I	SHUTDOWN	The device enters in shutdown mode when a low level is applied on this pin.
3	I	BYPASS	Bypass capacitor pin which provides the common mode voltage ($V_P/2$).
4	O	REF_I	Virtual ground amplifier feed back. This pin sets the stereo headset ground. In order to improve crosstalk, this pin must be connected as close as possible to the ground connection of the headset (ideally at the ground pin of the headset connector). When one uses bypassing capacitors, this pin must be left unconnected.
5	I	IN_L	Negative input of the first amplifier. It receives the audio input signal. Connected to the input capacitor C_{in} (NCP2809A) or the external R_{in} (NCP2809B).
6	O	OUT_L	Stereo headset amplifier analog output left. This pin will output the amplified analog signal and, depending on the application, must be coupled with a capacitor or directly connected to the left loudspeaker of the headset. This output is able to drive a 16 Ω load in a single-ended configuration.
7	I	V_P	Positive analog supply of the cell. Range: 2.2 V – 5.5 V
8	O	OUT_I	Virtual ground for stereo Headset common connection. This pin is directly connected to the common connection of the headset when use of bypassing capacitor is not required. When one uses bypassing capacitors, this pin must be left unconnected.
9	I	V_M	Analog Ground
10	O	OUT_R	Stereo headset amplifier analog output right. This pin will output the amplified analog signal and, depending on the application, must be coupled with a capacitor or directly connected to the right loudspeaker of the headset. This output is able to drive a 16 Ω load in a single-ended configuration.

MAXIMUM RATINGS ($T_A = +25^\circ\text{C}$)

Rating	Symbol	Value	Unit
Supply Voltage	V_P	6.0	V
Operating Supply Voltage	$O_P V_P$	2.2 to 5.5	V
Input Voltage	V_{in}	-0.3 to $V_{CC} + 0.3$	V
Max Output Current	I_{out}	250	mA
Power Dissipation	P_d	Internally Limited	–
Operating Ambient Temperature	T_A	-40 to +85	$^\circ\text{C}$
Max Junction Temperature	T_J	150	$^\circ\text{C}$
Storage Temperature Range	T_{stg}	-65 to +150	$^\circ\text{C}$
Thermal Resistance, Junction-to-Air	$R_{\theta JA}$	200	$^\circ\text{C}/\text{W}$
ESD Protection	Human Body Model (HBM) (Note 1)	8000	V
	Machine Model (MM) (Note 2)	200	
Latch up current at $T_a = 85^\circ\text{C}$ (Note 3)		± 100	mA

Maximum ratings applied to the device are individual stress limit values (not normal operating conditions) and are not valid simultaneously. If stress limits are exceeded device functional operation is not implied, damage may occur and reliability may be affected. Functional operation should be restricted to the Recommended Operating Conditions.

- Human Body Model, 100 pF discharged through a 1.5 k Ω resistor following specification JESD22/A114 8.0 kV can be applied on OUT_L, OUT_R, REF_I and OUT_I outputs. For other pins, 2.0 kV is the specified voltage.
- Machine Model, 200 pF discharged through all pins following specification JESD22/A115.
- Maximum ratings per JEDEC standard JESD78.

*This device contains 752 active transistors and 1740 MOS gates.

NCP2809 Series

ELECTRICAL CHARACTERISTICS All the parameters are given in the capless configuration (typical application). The following parameters are given for the NCP2809A and NCP2809B mounted externally with 0 dB gain, unless otherwise noted. (For typical values $T_A = 25^\circ\text{C}$, for min and max values $T_A = -40^\circ\text{C}$ to 85°C , $T_{Jmax} = 125^\circ\text{C}$, unless otherwise noted.)

Characteristic	Symbol	Conditions	Min (Note 4)	Typ	Max (Note 4)	Unit
Supply Quiescent Current	I_{DD}	$V_{in} = 0\text{ V}$, $R_L = 16\ \Omega$ $V_p = 2.4\text{ V}$ $V_p = 5.0\text{ V}$		1.54 1.84	2.8 3.6	mA
Output Offset Voltage	V_{off}	$V_p = 2.4\text{ V}$ $V_p = 5.0\text{ V}$	-25	1.0	+25	mV
Shutdown Current	I_{SD}	$V_p = 5.0\text{ V}$		10	600	nA
Shutdown Voltage High (Note 5)	V_{SDIH}	-	1.2			V
Shutdown Voltage Low	V_{SDIL}	-			0.4	V
Turning On Time (Note 6)	T_{WU}	$C_{by} = 1.0\ \mu\text{F}$		285		ms
Turning Off Time (Note 6)	T_{SD}	$C_{by} = 1.0\ \mu\text{F}$ and $V_p = 5.0\text{ V}$		385		ms
Max Output Swing	$V_{loadpeak}$	$V_p = 2.4\text{ V}$, $R_L = 16\ \Omega$ $V_p = 5.0\text{ V}$, $R_L = 16\ \Omega$ $V_p = 2.4\text{ V}$, $R_L = 32\ \Omega$ $V_p = 5.0\text{ V}$, $R_L = 32\ \Omega$	0.82 1.94	0.9 2.05 1.04 2.26		V
Max Rms Output Power	P_{Orms}	$V_p = 2.4\text{ V}$, $R_L = 16\ \Omega$, THD+N<0.1% $V_p = 5.0\text{ V}$, $R_L = 16\ \Omega$, THD+N<0.1% $V_p = 2.4\text{ V}$, $R_L = 32\ \Omega$, THD+N<0.1% $V_p = 5.0\text{ V}$, $R_L = 32\ \Omega$, THD+N<0.1%		24 131 17 80		mW
Voltage Gain	G	NCP2809A only	-0.5	0	+0.5	dB
Crosstalk	CS	$f = 1.0\text{ kHz}$ $V_p = 2.4\text{ V}$, $R_L = 16\ \Omega$, $P_{out} = 20\text{ mW}$ $V_p = 2.4\text{ V}$, $R_L = 32\ \Omega$, $P_{out} = 10\text{ mW}$ $V_p = 3.0\text{ V}$, $R_L = 16\ \Omega$, $P_{out} = 30\text{ mW}$ $V_p = 3.0\text{ V}$, $R_L = 32\ \Omega$, $P_{out} = 20\text{ mW}$ $V_p = 5.0\text{ V}$, $R_L = 16\ \Omega$, $P_{out} = 75\text{ mW}$ $V_p = 5.0\text{ V}$, $R_L = 32\ \Omega$, $P_{out} = 50\text{ mW}$		-63.5 -72.5 -64 -73 -64 -73		dB
Signal to Noise Ratio	SNR	$f = 1.0\text{ kHz}$ $V_p = 2.4\text{ V}$, $R_L = 16\ \Omega$, $P_{out} = 20\text{ mW}$ $V_p = 2.4\text{ V}$, $R_L = 32\ \Omega$, $P_{out} = 10\text{ mW}$ $V_p = 3.0\text{ V}$, $R_L = 16\ \Omega$, $P_{out} = 30\text{ mW}$ $V_p = 3.0\text{ V}$, $R_L = 32\ \Omega$, $P_{out} = 20\text{ mW}$ $V_p = 5.0\text{ V}$, $R_L = 16\ \Omega$, $P_{out} = 75\text{ mW}$ $V_p = 5.0\text{ V}$, $R_L = 32\ \Omega$, $P_{out} = 50\text{ mW}$		88.3 89 90.5 92 95.1 96.1		dB

4. Min/Max limits are guaranteed by production test.
5. At $T_A = -40^\circ\text{C}$, the minimum value is set to 1.5 V.
6. See page 10 for a theoretical approach to these parameters.

NCP2809 Series

ELECTRICAL CHARACTERISTICS All the parameters are given in the capless configuration (typical application). The following parameters are given for the NCP2809A and NCP2809B mounted externally with 0 dB gain, unless otherwise noted. (For typical values $T_A = 25^\circ\text{C}$, for min and max values $T_A = -40^\circ\text{C}$ to 85°C , $T_{Jmax} = 125^\circ\text{C}$, unless otherwise noted.)

Characteristic	Symbol	Conditions	Min (Note 7)	Typ	Max (Note 7)	Unit
Positive Supply Rejection Ratio	PSRR V+	$R_L = 16 \Omega$ $V_{\text{ripple_pp}} = 200 \text{ mV}$ $C_{\text{by}} = 1.0 \mu\text{F}$ Input Terminated with 10Ω NCP2809A $F = 217 \text{ Hz}$ $V_p = 5.0 \text{ V}$ $V_p = 2.4 \text{ V}$ $F = 1.0 \text{ kHz}$ $V_p = 5.0 \text{ V}$ $V_p = 2.4 \text{ V}$		-73 -82 -73 -85		dB
Positive Supply Rejection Ratio	PSRR V+	$R_L = 16 \Omega$ $V_{\text{ripple_pp}} = 200 \text{ mV}$ $C_{\text{by}} = 1.0 \mu\text{F}$ Input Terminated with 10Ω NCP2809B with 0 dB External Gain $F = 217 \text{ Hz}$ $V_p = 5.0 \text{ V}$ $V_p = 2.4 \text{ V}$ $F = 1.0 \text{ kHz}$ $V_p = 5.0 \text{ V}$ $V_p = 2.4 \text{ V}$		-80 -82 -81 -81		dB
Efficiency	η	$V_p = 5.0 \text{ V}$, $R_L = 16 \Omega = 135 \text{ mW}$		63		%
Thermal Shutdown Temperature (Note 8)	T_{sd}	-		160		$^\circ\text{C}$
Total Harmonic Distortion + Noise (Note 9)	THD+N	$V_p = 2.4 \text{ V}$, $f = 1.0 \text{ kHz}$ $R_L = 16 \Omega$, $P_{\text{out}} = 20 \text{ mW}$ $R_L = 32 \Omega$, $P_{\text{out}} = 15 \text{ mW}$ $V_p = 5.0 \text{ V}$, $f = 1.0 \text{ kHz}$ $R_L = 16 \Omega$, $P_{\text{out}} = 120 \text{ mW}$ $R_L = 32 \Omega$, $P_{\text{out}} = 70 \text{ mW}$		0.006 0.004 0.005 0.003		%

7. Min/Max limits are guaranteed by production test.
8. This thermal shutdown is made with an hysteresis function. Typically, the device turns off at 160°C and turns on again when the junction temperature is less than 140°C .
9. The outputs of the device are sensitive to a coupling capacitor to Ground. To ensure THD+N at very low level for any sort of headset (16Ω or 32Ω), outputs (OUT_R, OUT_L, OUT_I and REF_I) must not be grounded with more than 500 pF .

NCP2809 Series

TYPICAL CHARACTERISTICS

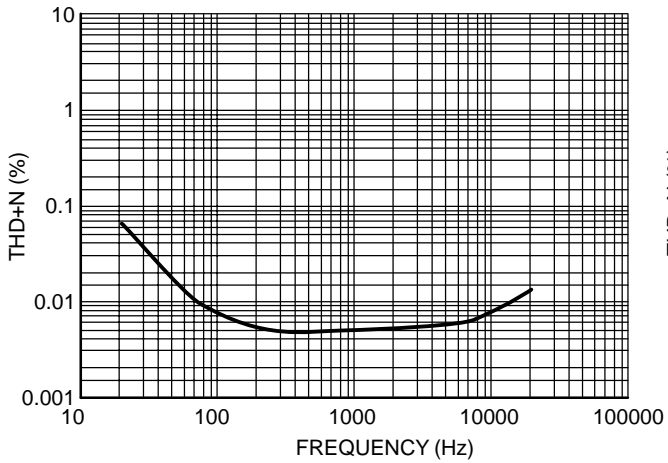

Figure 6. THD+N vs. Frequency
 $V_p = 5.0 \text{ V}$, $R_L = 16 \Omega$, $P_{out} = 75 \text{ mW}$

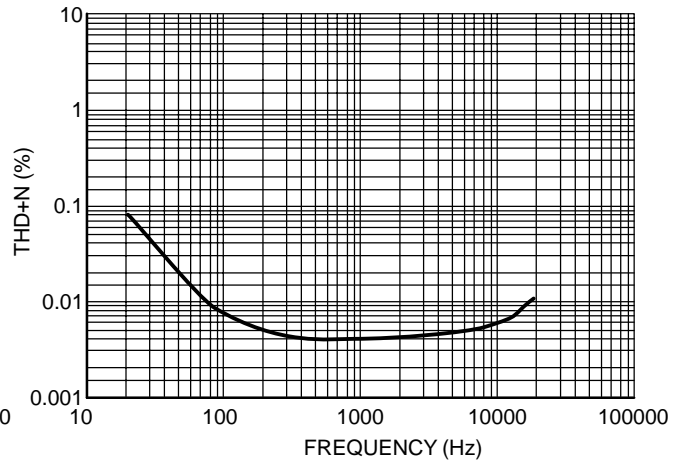

Figure 7. THD+N vs. Frequency
 $V_p = 5.0 \text{ V}$, $R_L = 32 \Omega$, $P_{out} = 50 \text{ mW}$

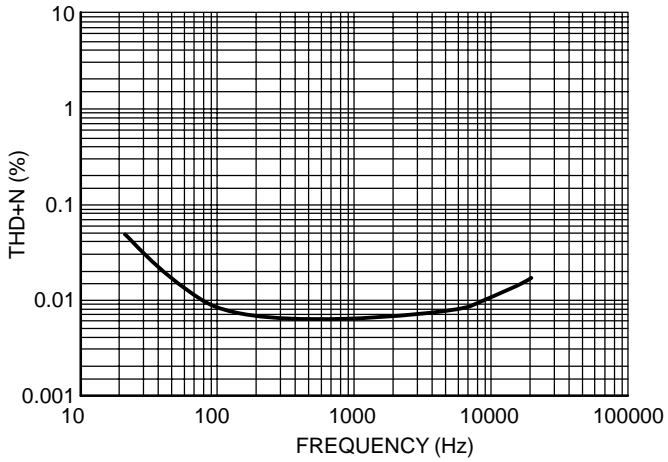

Figure 8. THD+N vs. Frequency
 $V_p = 3.0 \text{ V}$, $R_L = 16 \Omega$, $P_{out} = 30 \text{ mW}$

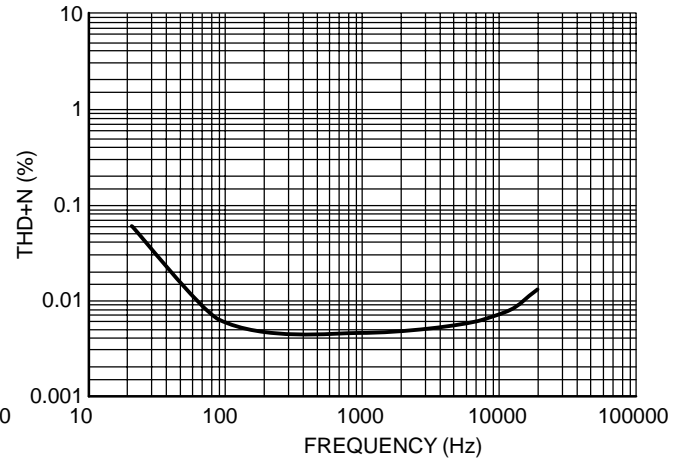

Figure 9. THD+N vs. Frequency
 $V_p = 3.0 \text{ V}$, $R_L = 32 \Omega$, $P_{out} = 20 \text{ mW}$

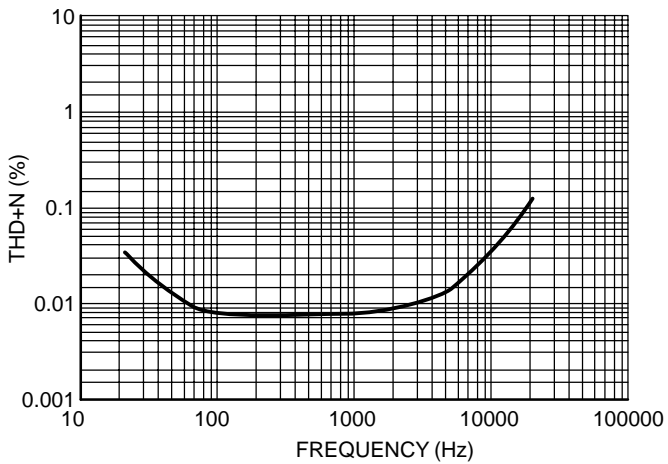

Figure 10. THD+N vs. Frequency
 $V_p = 2.4 \text{ V}$, $R_L = 16 \Omega$, $P_{out} = 20 \text{ mW}$

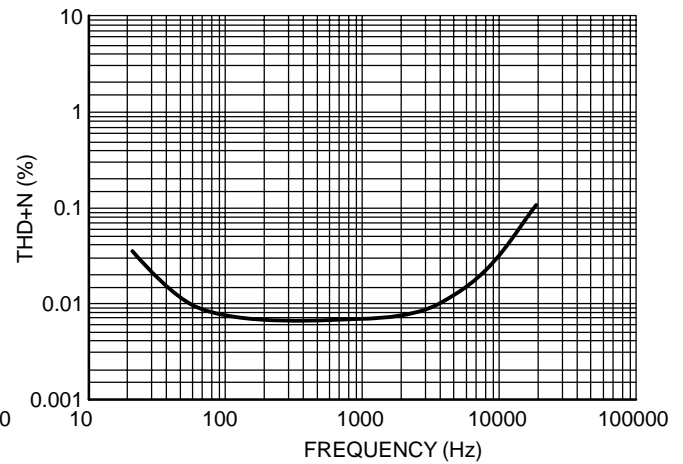

Figure 11. THD+N vs. Frequency
 $V_p = 2.4 \text{ V}$, $R_L = 32 \Omega$, $P_{out} = 10 \text{ mW}$

NCP2809 Series

TYPICAL CHARACTERISTICS

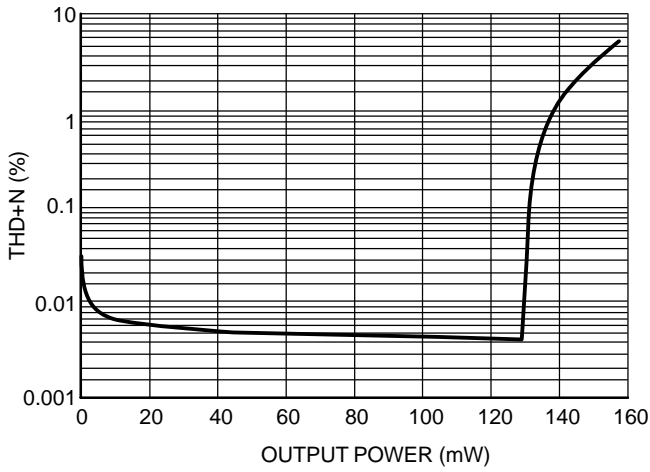

Figure 12. THD+N vs. Power Out
 $V_p = 5.0 \text{ V}$, $R_L = 16 \Omega$, 1.0 kHz

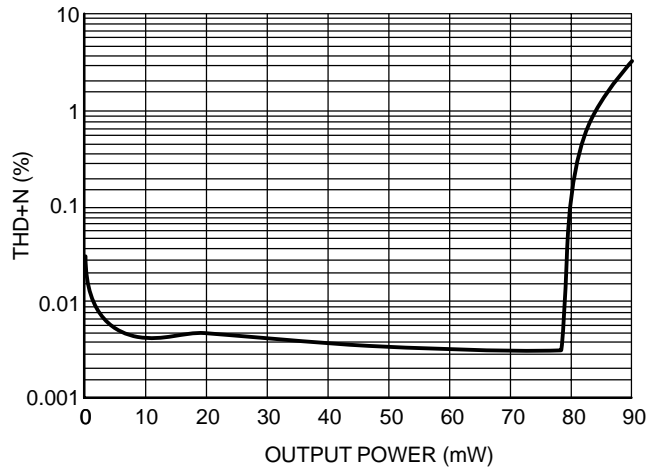

Figure 13. THD+N vs. Power Out
 $V_p = 5.0 \text{ V}$, $R_L = 32 \Omega$, 1.0 kHz

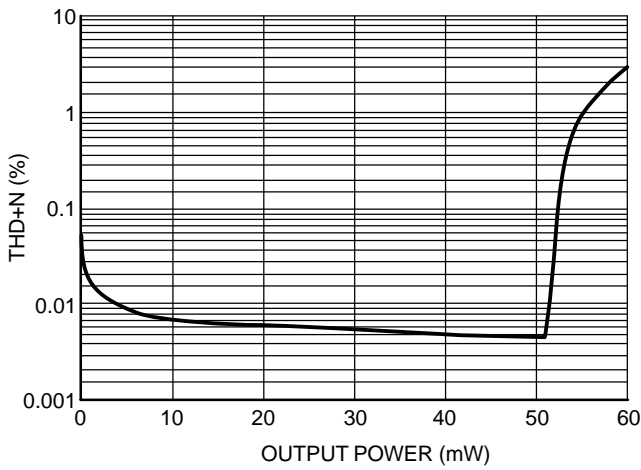

Figure 14. THD+N vs. Power Out
 $V_p = 3.3 \text{ V}$, $R_L = 16 \Omega$, 1.0 kHz

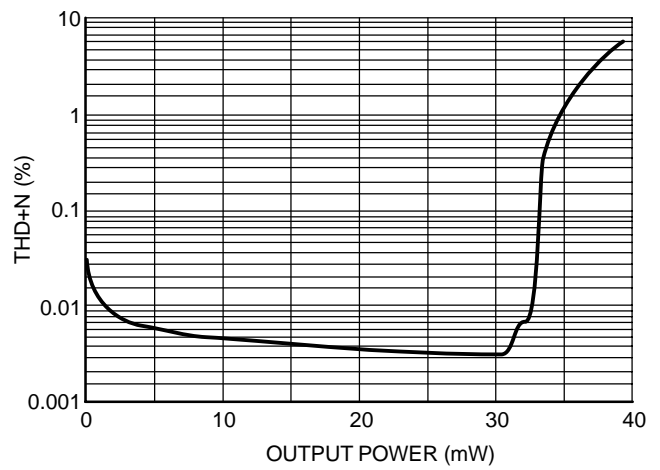

Figure 15. THD+N vs. Power Out
 $V_p = 3.3 \text{ V}$, $R_L = 32 \Omega$, 1.0 kHz

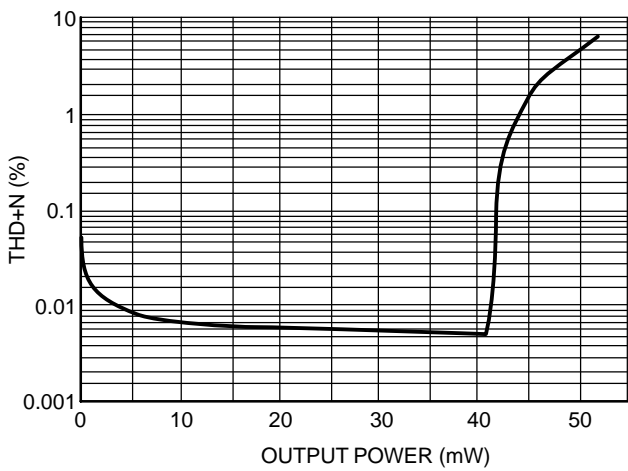

Figure 16. THD+N vs. Power Out
 $V_p = 3.0 \text{ V}$, $R_L = 16 \Omega$, 1.0 kHz

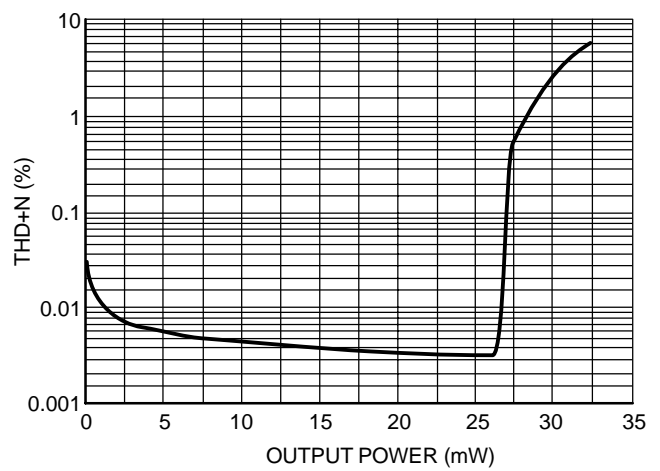

Figure 17. THD+N vs. Power Out
 $V_p = 3.0 \text{ V}$, $R_L = 32 \Omega$, 1.0 kHz

NCP2809 Series

TYPICAL CHARACTERISTICS

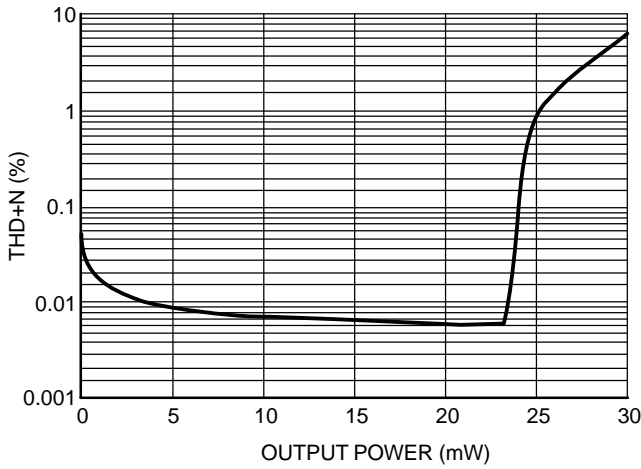

Figure 18. THD+N vs. Power Out
 $V_p = 2.4 \text{ V}$, $R_L = 16 \Omega$, 1.0 kHz

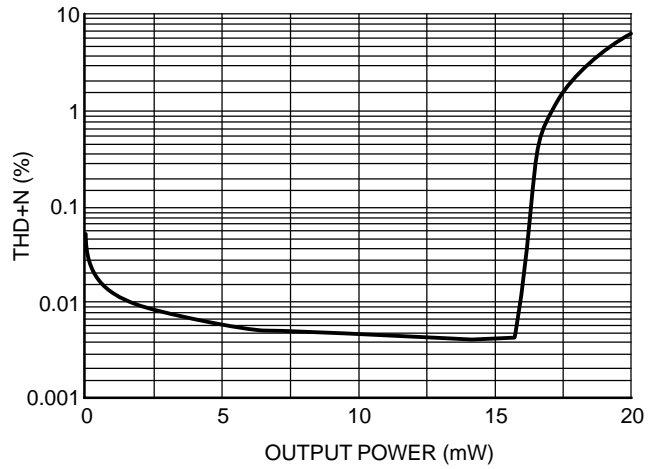

Figure 19. THD+N vs. Power Out
 $V_p = 2.4 \text{ V}$, $R_L = 3.2 \Omega$, 1.0 kHz

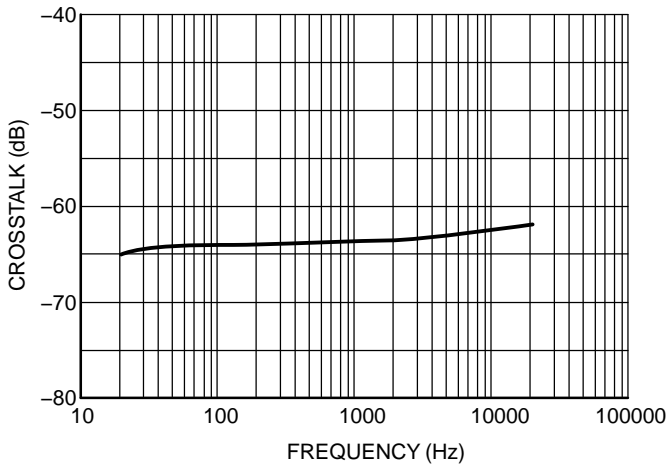

Figure 20. Crosstalk
 $V_p = 5.0 \text{ V}$, $R_L = 16 \Omega$, $P_{out} = 75 \text{ mW}$

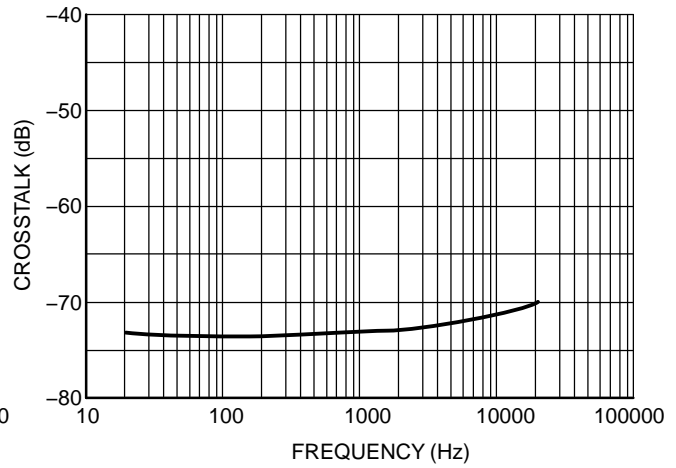

Figure 21. Crosstalk
 $V_p = 5.0 \text{ V}$, $R_L = 32 \Omega$, $P_{out} = 50 \text{ mW}$

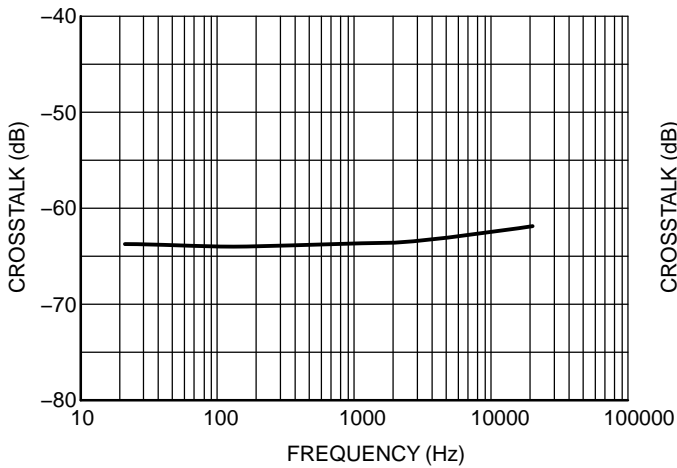

Figure 22. Crosstalk
 $V_p = 3.0 \text{ V}$, $R_L = 16 \Omega$, $P_{out} = 30 \text{ mW}$

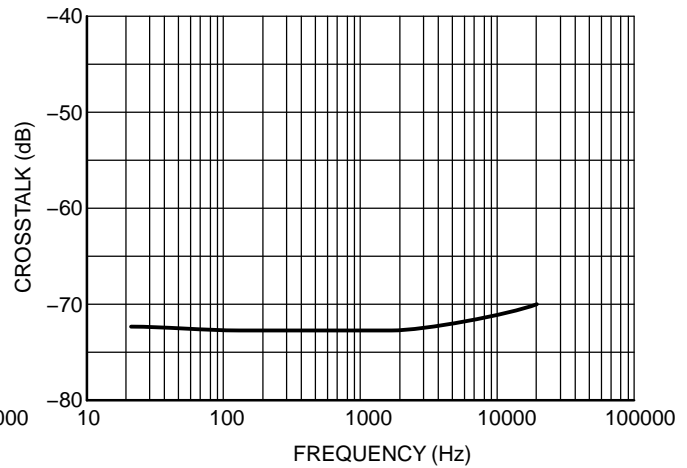

Figure 23. Crosstalk
 $V_p = 3.0 \text{ V}$, $R_L = 32 \Omega$, $P_{out} = 20 \text{ mW}$

NCP2809 Series

TYPICAL CHARACTERISTICS

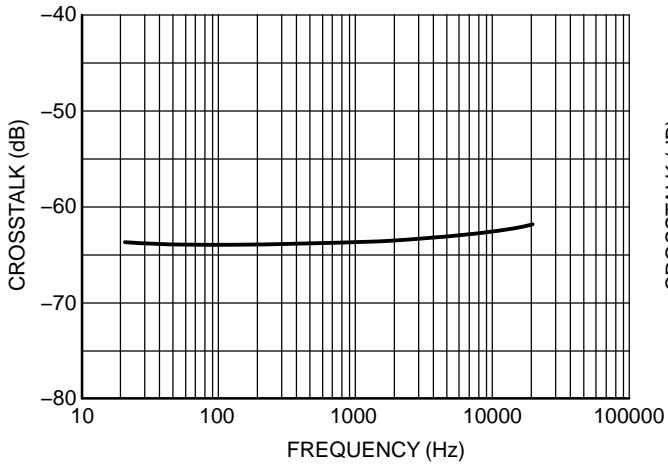

Figure 24. Crosstalk
 $V_p = 2.4\text{ V}$, $R_L = 16\ \Omega$, $P_{out} = 20\text{ mW}$

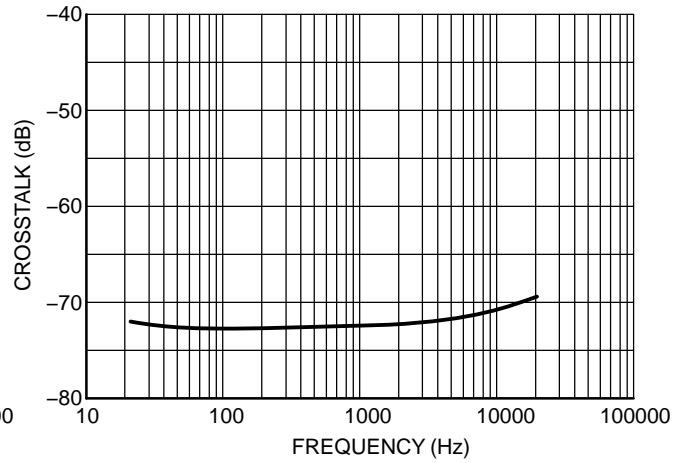

Figure 25. Crosstalk
 $V_p = 2.4\text{ V}$, $R_L = 32\ \Omega$, $P_{out} = 10\text{ mW}$

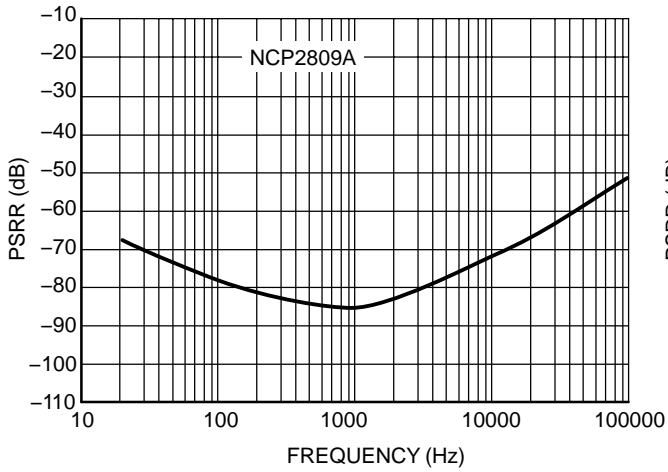

Figure 26. PSRR – Input Grounded with $10\ \Omega$
 $V_p = 2.4\text{ V}$, $V_{ripple} = 200\text{ mV pk-pk}$, $R_L = 16\ \Omega$

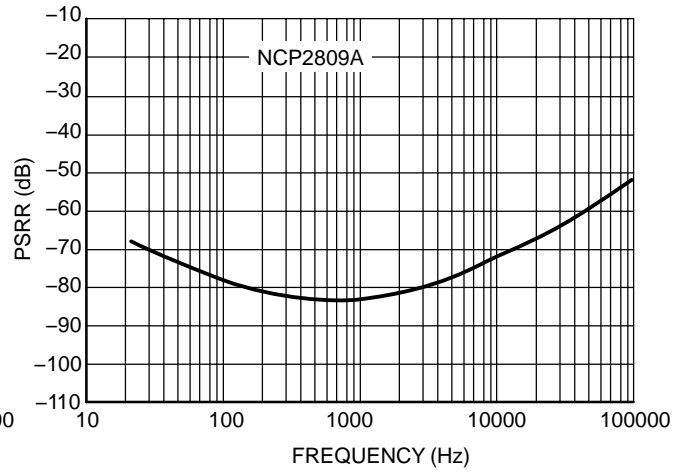

Figure 27. PSRR – Input Grounded with $10\ \Omega$
 $V_p = 2.4\text{ V}$, $V_{ripple} = 200\text{ mV pk-pk}$, $R_L = 32\ \Omega$

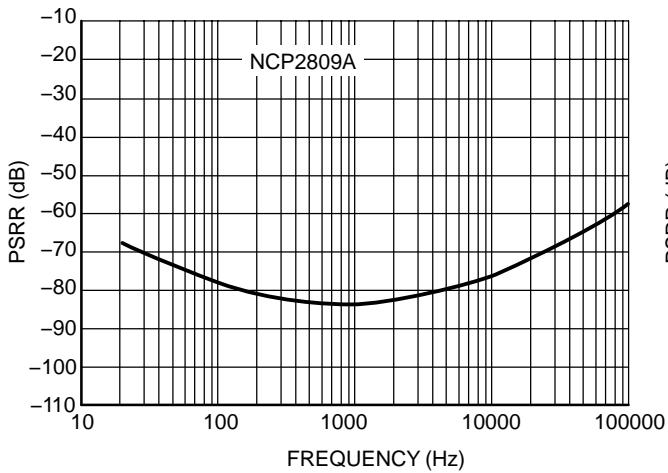

Figure 28. PSRR – Input Grounded with $10\ \Omega$
 $V_p = 3.0\text{ V}$, $V_{ripple} = 200\text{ mV pk-pk}$, $R_L = 16\ \Omega$

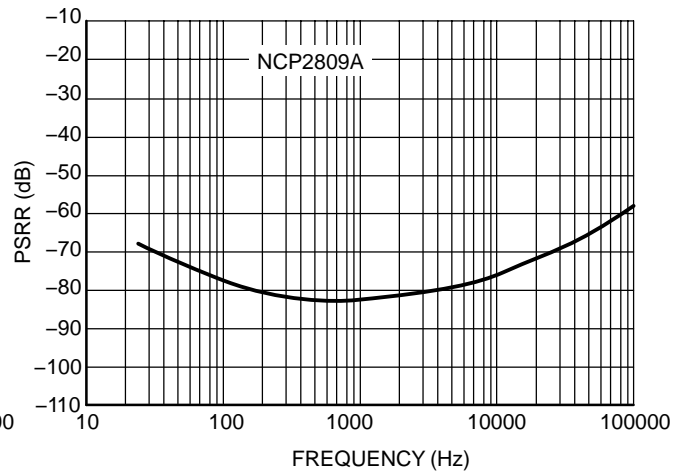

Figure 29. PSRR – Input Grounded with $10\ \Omega$
 $V_p = 3.0\text{ V}$, $V_{ripple} = 200\text{ mV pk-pk}$, $R_L = 32\ \Omega$

NCP2809 Series

TYPICAL CHARACTERISTICS

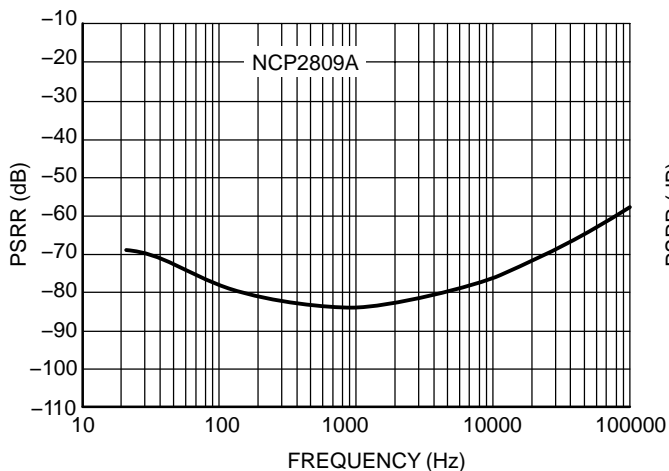

Figure 30. PSRR – Input Grounded with 10 Ω
 $V_p = 3.3\text{ V}$, $V_{\text{ripple}} = 200\text{ mV pk-pk}$, $R_L = 16\ \Omega$

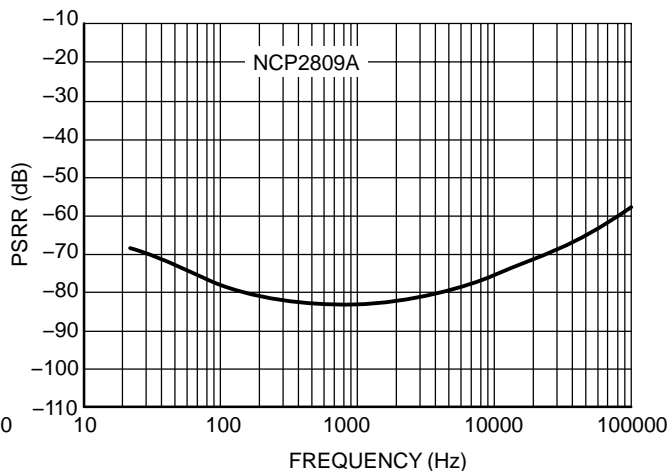

Figure 31. PSRR – Input Grounded with 10 Ω
 $V_p = 3.3\text{ V}$, $V_{\text{ripple}} = 200\text{ mV pk-pk}$, $R_L = 32\ \Omega$

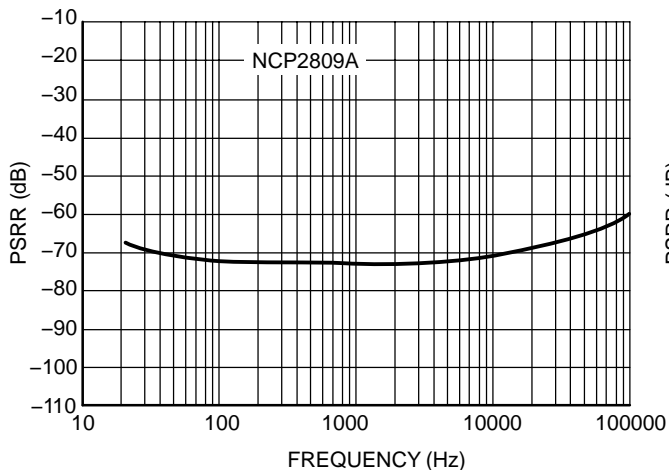

Figure 32. PSRR – Input Grounded with 10 Ω
 $V_p = 5.0\text{ V}$, $V_{\text{ripple}} = 200\text{ mV pk-pk}$, $R_L = 16\ \Omega$

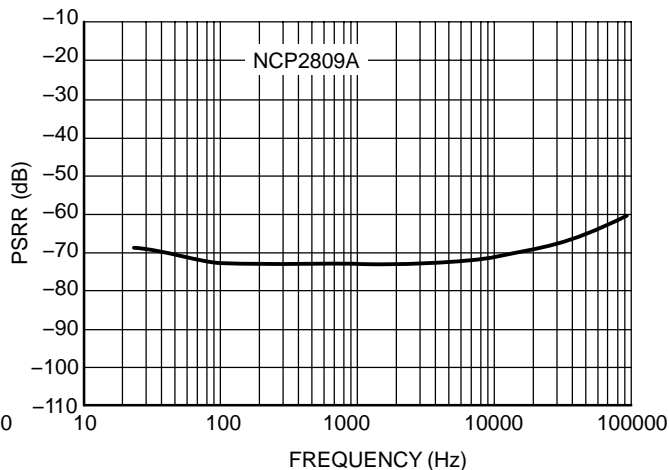

Figure 33. PSRR – Input Grounded with 10 Ω
 $V_p = 5.0\text{ V}$, $V_{\text{ripple}} = 200\text{ mV pk-pk}$, $R_L = 32\ \Omega$

NCP2809 Series

TYPICAL CHARACTERISTICS

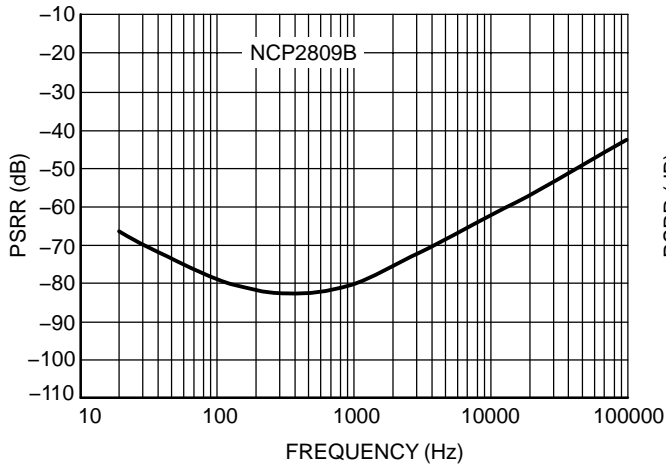

Figure 34. PSRR – Input Grounded with $10\ \Omega$
 $V_p = 2.4\ \text{V}$, $V_{\text{ripple}} = 200\ \text{mV pk-pk}$, $R_L = 16\ \Omega$,
 $G = 1\ (0\ \text{dB})$

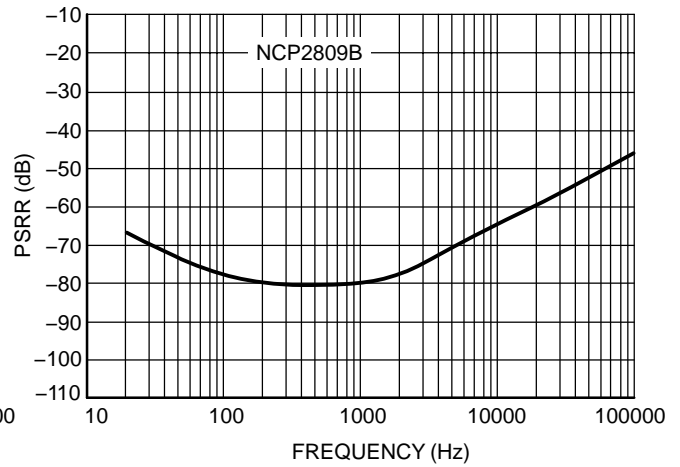

Figure 35. PSRR – Input Grounded with $10\ \Omega$
 $V_p = 5.0\ \text{V}$, $V_{\text{ripple}} = 200\ \text{mV pk-pk}$, $R_L = 16\ \Omega$,
 $G = 1\ (0\ \text{dB})$

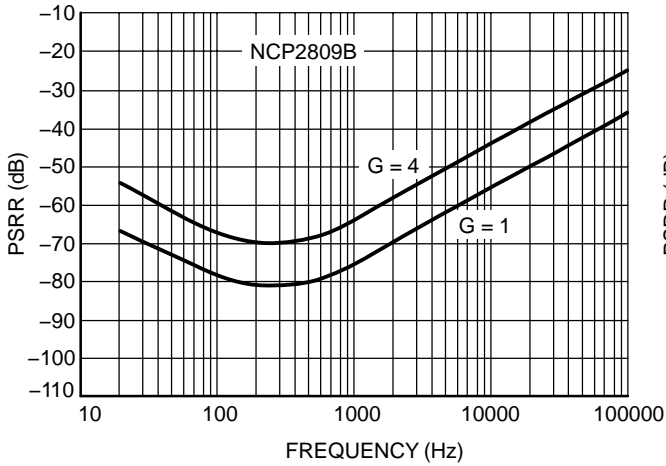

Figure 36. PSRR – Input Grounded with $10\ \Omega$
 $V_p = 2.4\ \text{V}$, $V_{\text{ripple}} = 200\ \text{mV pk-pk}$, $R_L = 16\ \Omega$,
 $G = 1\ (0\ \text{dB})$ and $G = 4\ (12\ \text{dB})$

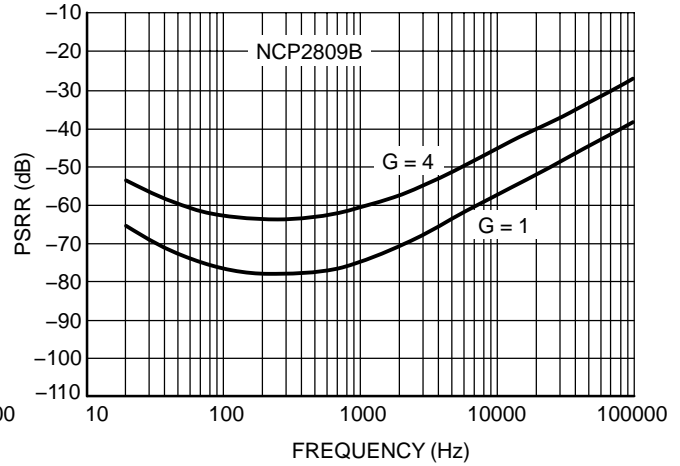

Figure 37. PSRR – Input Grounded with $10\ \Omega$
 $V_p = 5.0\ \text{V}$, $V_{\text{ripple}} = 200\ \text{mV pk-pk}$, $R_L = 16\ \Omega$,
 $G = 1\ (0\ \text{dB})$ and $G = 4\ (12\ \text{dB})$

NCP2809 Series

TYPICAL CHARACTERISTICS

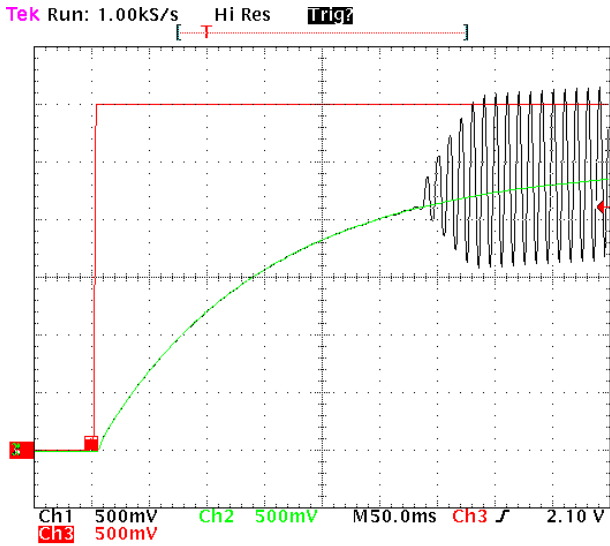

Figure 38. Turning-On Time/ $V_p = 5.0$ V
and $F = 100$ Hz
Ch1 = OUT_R, Ch2 = VMC and Ch3 = Shutdown

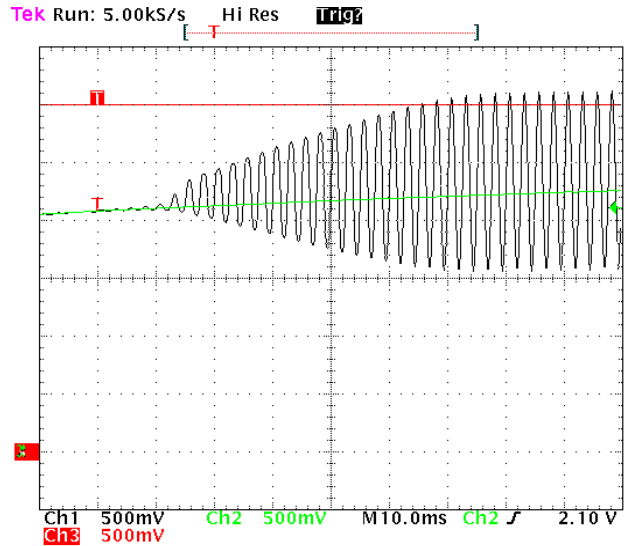

Figure 39. Turning-On Time Zoom/ $V_p = 5.0$ V
and $F = 400$ Hz
Ch1 = OUT_R, Ch2 = VMC and Ch3 = Shutdown

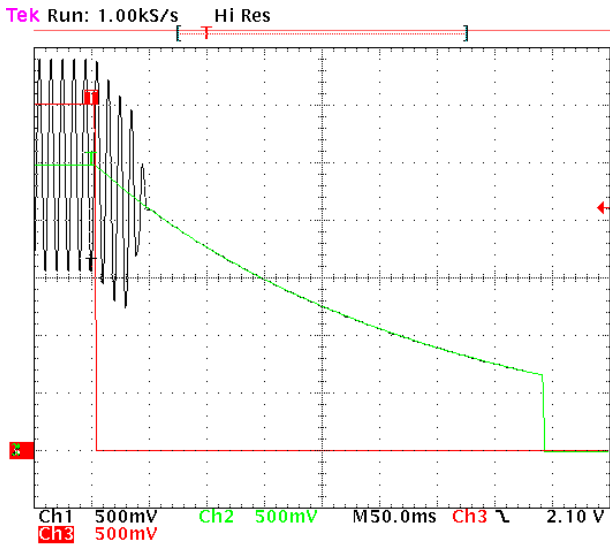

Figure 40. Turning-Off Time/ $V_p = 5.0$ V
and $F = 100$ Hz
Ch1 = OUT_R, Ch2 = VMC and Ch3 = Shutdown

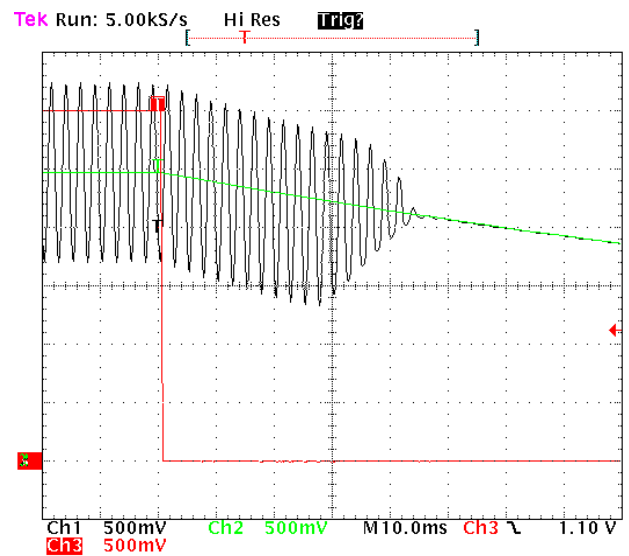

Figure 41. TurningOff Time Zoom/ $V_p = 5.0$ V
and $F = 400$ Hz
Ch1 = OUT_R, Ch2 = VMC and Ch3 = Shutdown

APPLICATION INFORMATION

Detailed Description

The NCP2809 power audio amplifier can operate from 2.6 V to 5.0 V power supply. It delivers 24 mW_{rms} output power to a 16 Ω load (V_P = 2.4 V) and 131 mW_{rms} output power to a 16 Ω load (V_P = 5.0 V).

The structure of NCP2809 is basically composed of two identical internal power amplifiers; NCP2809A has a fixed internal gain of 0 dB and the gain can be set externally with the NCP2809B.

Internal Power Amplifier

The output P_{mos} and N_{mos} transistors of the amplifier are designed to deliver the specified output power without clipping. The channel resistance (R_{on}) of the N_{mos} and P_{mos} transistors does not exceed 3.0 Ω when driving current.

The structure of the internal power amplifier is composed of three symmetrical gain stages, first and medium gain stages are transconductance gain stages in order to maximize bandwidth and DC gain.

Turn-On and Turn-Off Transitions

A Turn-on/off transition is shown in the following plot corresponding to curves in Figures 38 to 41.

In order to eliminate “pop and click” noises during transitions, output power in the load must be slowly established or cut. When logic high is applied to the shutdown pin, the bypass voltage begins to rise exponentially and once the output DC level is around the common mode voltage, the gain is established slowly (50 ms). This way to turn-on the device is optimized in terms of rejection of “pop and click” noises.

The device has the same behavior when turned-off by a logic low on the shutdown pin. During the shutdown mode, amplifier outputs are connected to the ground.

A theoretical value of turn-on and off times at 25°C is given by the following formula.

C_{by}: Bypass Capacitor

R: Internal 300 k resistor with a 25% accuracy

$$T_{on} = 0.95 * R * C_{by}$$

$$T_{off} = R * C_{by} * \ln(V_p/1.4)$$

Shutdown Function

The device enters shutdown mode when shutdown signal is low. During the shutdown mode, the DC quiescent current of the circuit does not exceed 600 nA.

Current Limit Protection Circuitry

The maximum output power of the circuit (P_{O_{rms}} = 135 mW, V_P = 5.0 V, R_L = 16 Ω) requires a peak current in the load of 130 mA.

In order to limit excessive power dissipation in the load when a short-circuit occurs, the current limit in the load is fixed to 250 mA. The current in the output MOS transistors is real-time monitored, and when exceeding 250 mA, the gate voltage of the corresponding MOS transistor is clipped and no more current can be delivered.

Thermal Overload Protection Circuitry

Internal amplifiers are switched off when temperature exceeds 160°C, and will be switched back on only when the temperature goes below 140°C.

NCP2809 is a stereo power audio amplifier.

If the application requires a Single Ended topology with output coupling capacitors, then the current provided by the battery for one output is as following:

- V_O(t) is the AC voltage seen by the load. Here we consider a sine wave signal with a period T and a peak voltage V_O.
- R_L is the load.

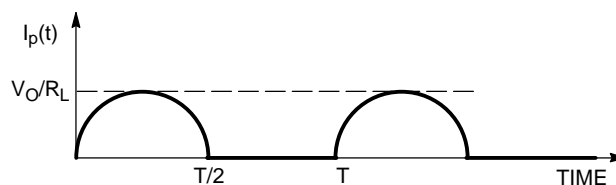

So, the total power delivered by the battery to the device is:

$$P_{TOT} = V_p \times I_{pavg}$$

$$I_{pavg} = \frac{1}{2\pi} \times \int_0^{\pi} \frac{V_O}{R_L} \sin(t) dt = \frac{V_O}{\pi \cdot R_L}$$

$$P_{TOT} = \frac{V_p \cdot V_O}{\pi \cdot R_L}$$

The power in the load is P_{OUT}.

$$P_{OUT} = \frac{V_O^2}{2R_L}$$

NCP2809 Series

The dissipated power by the device is

$$P_D = P_{TOT} - P_{OUT}$$

$$P_D = \frac{V_o}{R_L} \times \left[\frac{V_P}{\pi} - \frac{V_O}{2} \right]$$

At a given power supply voltage, the maximum power dissipated is:

$$P_{Dmax} = \frac{V_P^2}{2\pi^2 \cdot R_L}$$

Of course, if the device is used in a typical stereo application, each load with the same output power will give the same dissipated power. Thus the total lost power for the device is:

$$P_D = \frac{V_o}{R_L} \times \left[\frac{2V_P}{\pi} - V_O \right]$$

And in this case, the maximum power dissipated will be:

$$P_{Dmax} = \frac{V_P^2}{\pi^2 \cdot R_L}$$

In single ended operation, the efficiency is:

$$\eta = \frac{\pi \cdot V_O}{2V_P}$$

If the application requires a NOCAP scheme without output coupling capacitors, then the current provided by the battery for one output is as following:

- $V_o(t)$ is the AC voltage seen by the load. Here we consider a sine wave signal with a period T and a peak voltage V_o .
- R_L is the load.

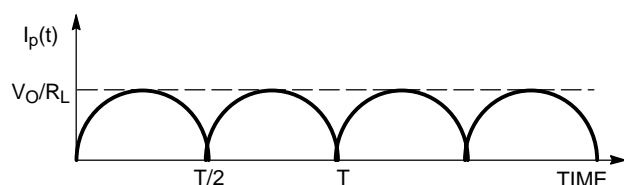

So, the total power delivered by the battery to the device is:

$$P_{TOT} = V_P \times I_{pavg}$$

$$I_{pavg} = \frac{1}{\pi} \times \int_0^{\pi} \frac{V_o}{R_L} \sin(t) dt = \frac{2V_o}{\pi \cdot R_L}$$

$$P_{TOT} = \frac{2V_P \cdot V_o}{\pi \cdot R_L}$$

The power in the load is P_{OUT}

$$P_{OUT} = \frac{V_o^2}{2R_L}$$

The dissipated power by the device is

$$P_D = P_{TOT} - P_{OUT}$$

$$P_D = \frac{V_o}{R_L} \times \left[\frac{2V_P}{\pi} - \frac{V_O}{2} \right]$$

At a given power supply voltage, the maximum power dissipated is:

$$P_{Dmax} = \frac{2V_P^2}{\pi^2 \cdot R_L}$$

Of course, if the device is used in a typical stereo application, each load with the same output power will give the same dissipated power. Thus the total lost power for the device is:

$$P_D = \frac{V_o}{R_L} \times \left[\frac{4V_P}{\pi} - V_O \right]$$

And in this case, the maximum power dissipated will be:

$$P_{Dmax} = \frac{4V_P^2}{\pi^2 \cdot R_L}$$

In NOCAP operation, the efficiency is:

$$\eta = \frac{\pi \cdot V_O}{4V_P}$$

Gain-Setting Selection

With NCP2809 Audio Amplifier family, you can select a closed-loop gain of 0db for the NCP2809A and an external gain setting with the NCP2809B. In order to optimize device and system performance, NCP2809 needs to be used in low gain configurations. It minimizes THD+N values and maximizes the signal-to-noise ratio, and the amplifier can still be used without running into the bandwidth limitations.

NCP2809A can be used when a 0 dB gain is required. Adjustable gain is available on NCP2809B.

NCP2809 Amplifier External Components

Input Capacitor Selection (C_{in})

The input coupling capacitor blocks the DC voltage at the amplifier input terminal. This capacitor creates a high-pass filter with the internal $R_{internal}$ resistor of 50 k Ω , the cut-off frequency of which is given by:

$$f_c = \frac{1}{2 * \pi * R_{in} * C_{in}} \quad (\text{eq. 1})$$

The size of the capacitor must be large enough to couple in low frequencies without severe attenuation. However a large input coupling capacitor requires more time to reach its quiescent DC voltage ($V_P/2$) and can increase the turn-on pops.

An input capacitor value of 100 nF performs well in many applications (With $R_{internal} = 50$ k Ω).

Bypass Capacitor Selection (C_{bypass})

The bypass capacitor C_{by} provides half-supply filtering and determines how fast the NCP2809 turns on.

A proper supply bypassing is critical for low noise performance and high power supply rejection ratio.

Moreover, this capacitor is a critical component to minimize the turn-on pop noise. A 1.0 μ F bypass capacitor value should produce clickless and popless shutdown transitions. The amplifier is still functional with a 0.1 μ F capacitor value but is more sensitive to “pop and click” noises.

Thus, for optimized performances, a 1.0 μ F ceramic bypassing capacitor is recommended.

Without Output Coupling Capacitor

As described in Figure 42, the internal circuitry of the NCP2809 device eliminates need of heavy bypassing capacitors when connecting a stereo headset with 3 connecting points. This circuitry produces a virtual ground and does not affect either output power or PSRR. Additionally, eliminating these capacitors reduces cost and PCB place.

However, user must take care to the connection between pin REF_I and ground of the headset: this pin is the ground reference for the headset. **So, in order to improve crosstalk performances, this pin must be plugged directly to the ground pin of the headset connector.**

With Output Coupling Capacitor

However, when using a low cost jack connector (with third connection to ground), the headset amplifier requires very few external components as described in Figure 43. Only two external coupling capacitors are needed. The main concern is in output coupling capacitors, because of the value and consequently the size of the components required. Purpose of these capacitors is biasing DC voltage and very low frequency elimination. Both, coupling capacitor and output load form a high pass filter. Audible frequency ranges from 20 Hz to 20 kHz, but headset used in portable appliance has poor ability to reproduce signals below 75 or 100 Hz. Input coupling capacitor and input resistance also form a high pass filter. These two first order filters form a second order high pass filter with the same -3 dB cut off frequency. Consequently, the following formula must be respected:

$$\frac{1}{2 * \pi * 50 \text{ k}\Omega * C_{in}} \approx \frac{1}{2 * \pi * R_L * C_{out}} \quad (\text{eq. 2})$$

Like for loudspeaker amplifier, the input impedance value for calculating filters cut off frequency is the minimum input impedance value at maximum output volume.

To obtain a frequency equal to when frequency is 5 times the cut off frequency, attenuation is 0.5 dB. So if we want a ± 0.5 dB at 150 Hz, we need to have a -3 dB cut off frequency of 30 Hz:

$$f_{-3dB} \geq \frac{1}{2 * \pi * R_L * C_{out}} \quad (\text{eq. 3})$$

$$C_{out} \geq \frac{1}{2 * \pi * R_L * f_{-3dB}} \quad (\text{eq. 4})$$

With $R_L = 16 \Omega$, and $f_{-3dB} = 30$ Hz formula (4) shows that $C_{out} \geq 330 \mu$ F.

With $C_{out} = 220 \mu$ F, ± 0.5 dB attenuation frequency will be 225 Hz with a -3.0 dB cut off frequency of 45 Hz. Following this, the input coupling capacitor choice is straightforward. Using formula (2) input coupling capacitor value would be 68 nF for a 220 μ F output coupling capacitor and 100 nF for a 330 μ F output coupling capacitor.

When using the NCP2809 with this configuration, pins REF_I and OUT_I must be left unconnected (see Figure 43).

NCP2809 Series

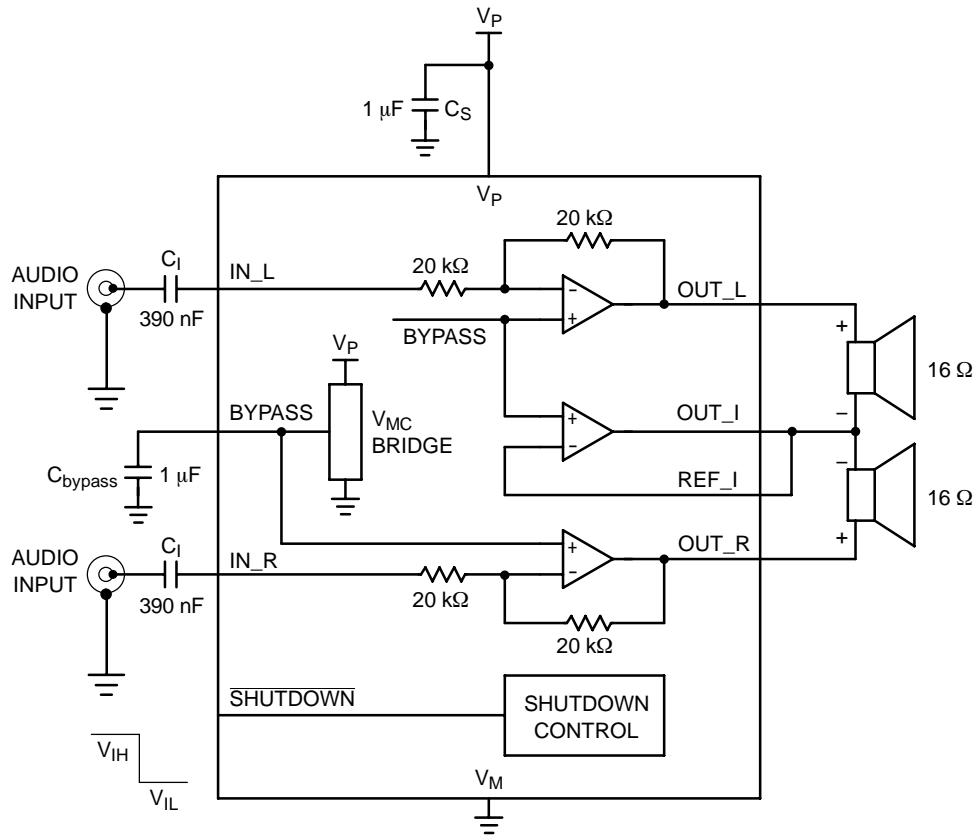

Figure 42. Typical Application Schematic Without Output Coupling Capacitor

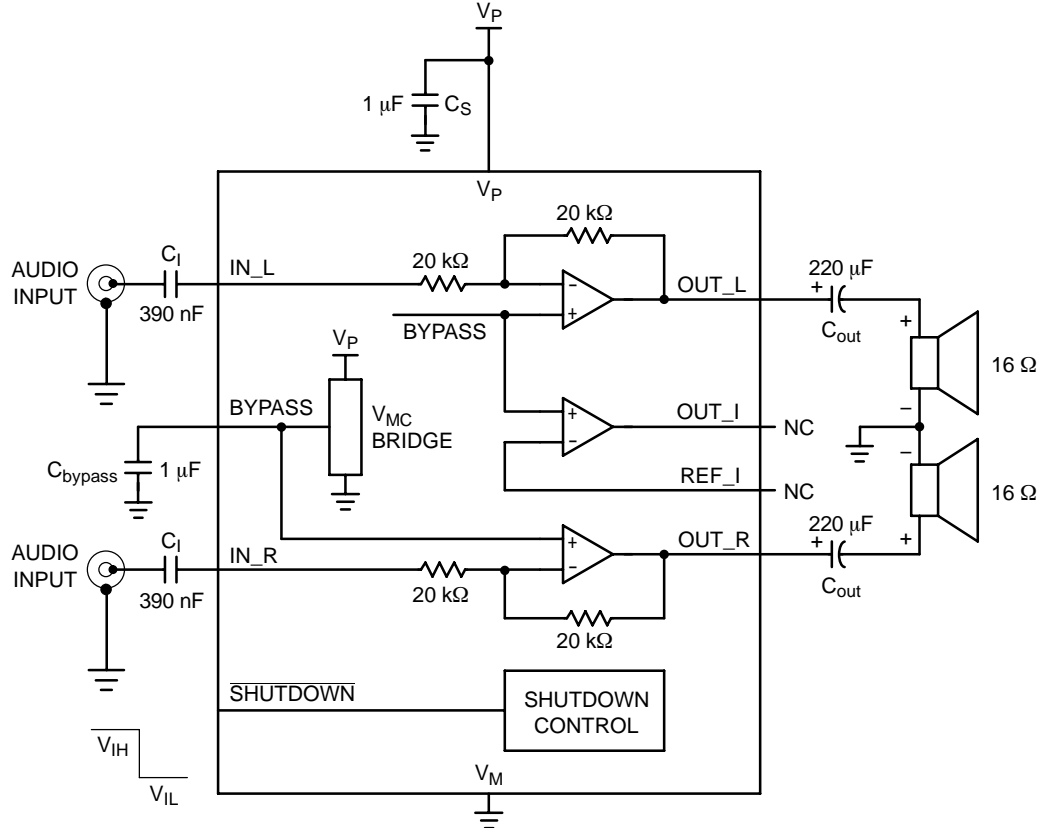

Figure 43. Typical Application Schematic With Output Coupling Capacitor

NCP2809 Series

DEMONSTRATION BOARD AND LAYOUT GUIDELINES

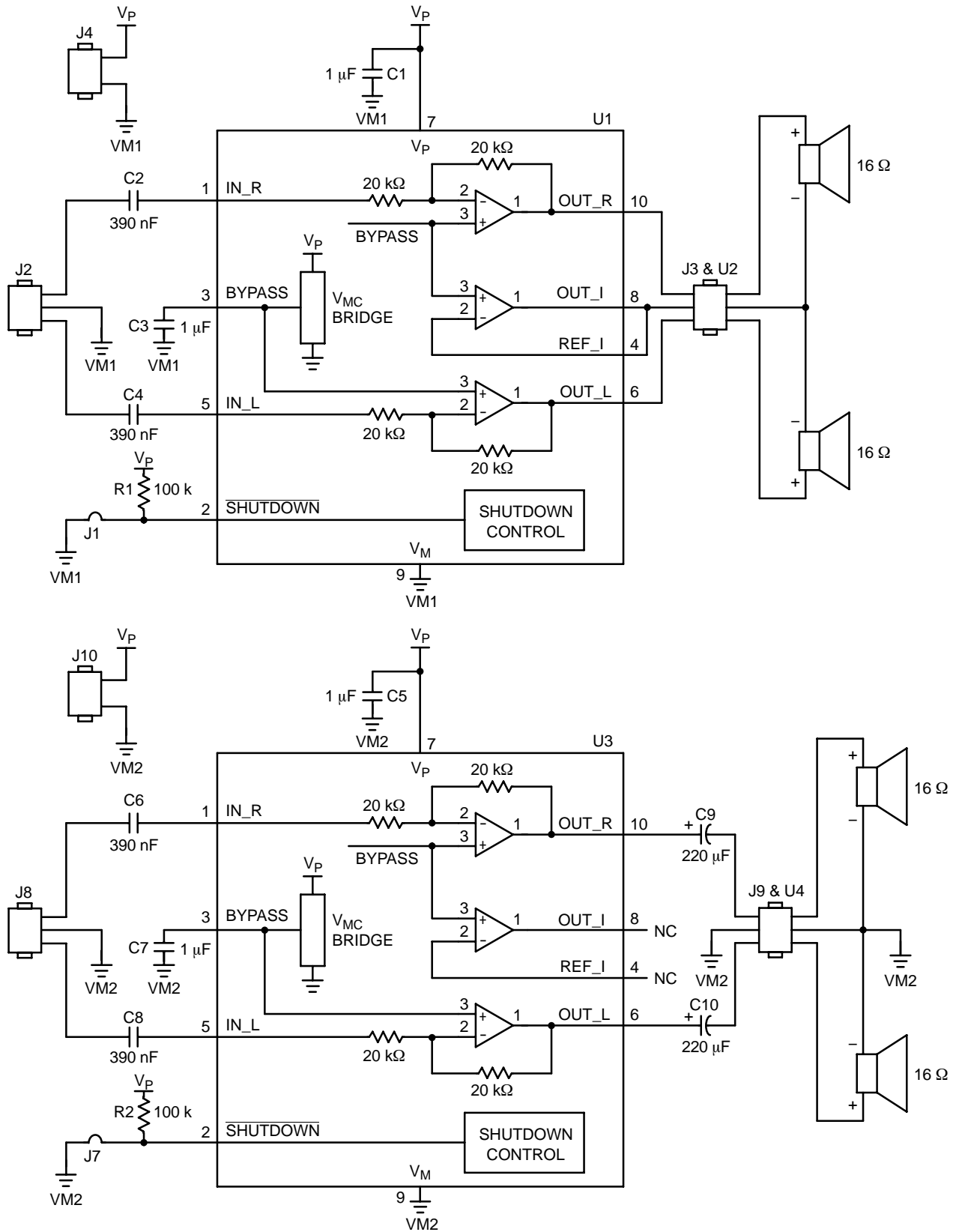
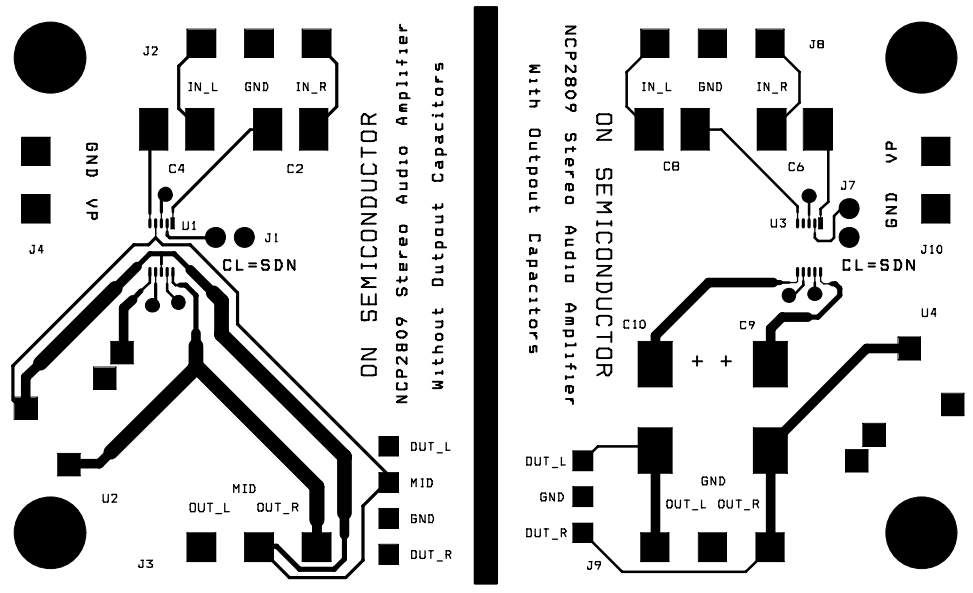
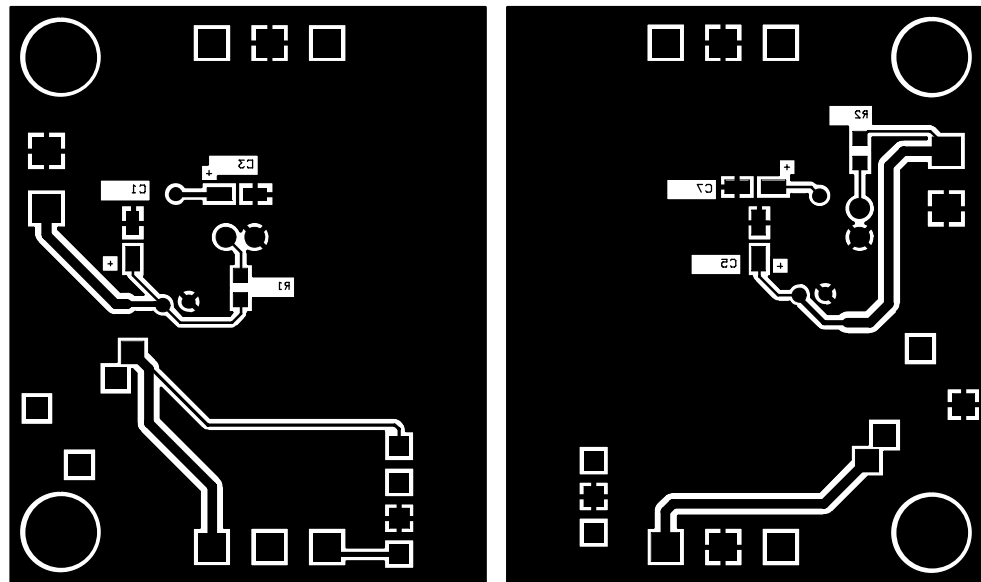

Figure 44. Schematic of the Demonstration Board for Micro10 Device

NCP2809 Series



TOP LAYER



BOTTOM LAYER

Figure 45. Demonstration Board for Micro10 Device – PCB Layers

NCP2809 Series

Table 1. Bill of Material

Item	Part Description	Ref.	PCB Footprint	Manufacturer	Manufacturer Reference
1	NCP2809 Audio Amplifier	U1,U3	Micro10	ON Semiconductor	NCP2809
2	SMD Resistor 100 K Ω	R1,R2	0805	Vishay–Draloric	D12CRCW Series
3	Ceramic Capacitor 390 nF 50 V Z5U	C2,C4, C6,C8	1812	Kemet	C1812C394M5UAC
4	Ceramic Capacitor 1.0 μ F 16 V X7R Optimized Performance	C1,C3, C5,C7	1206	Murata	GRM42–6X7R105K16
5	Tantalum Capacitor 220 μ F 10 V	C9,C10	–	Kemet	T495X227010AS
6	I/O Connector. It can be plugged by BLZ5.08/2 (Weidmüller Reference)	J4,J10	–	Weidmüller	SL5.08/2/90B
7	I/O Connector. It can be plugged by BLZ5.08/3 (Weidmüller Reference)	J2,J3, J8,J9	–	Weidmüller	SL5.08/3/90B
8	3.5 mm PCB Jack Connector	U2,U4	–	Decelect–Forgos	IES 101–3
9	Jumper Header Vertical Mount 2*1, 2.54 mm	J1,J7	–	–	–

PCB LAYOUT GUIDELINES

How to Optimize the Accuracy of VMC

The main innovation of the NCP2809 stereo NOCAP audio amplifier is the use of a virtual ground that allows connecting directly the headset on the outputs of the device saving DC–blocking output capacitors. In order to have the best performances in terms of crosstalk, noise and supply current, the feedback connection on the virtual ground amplifier is not closed internally. To reach this goal of excellence, one must connect OUT_I and REF_I as close as possible from the middle point of the output jack connector. The most suitable place for this connection is directly on the pad of this middle point.

How to Optimize THD+N Performances

To get the best THD+N level on the headset speakers, the traces of the power supply, ground, OUT_R, OUT_L and OUT_I need the lowest resistance. Thus, the PCB traces for these nets should be as wide and short as possible.

You need to avoid ground loops, run digital and analog traces parallel to each other. Due to its internal structure, the amplifier can be sensitive to coupling capacitors between Ground and each output (OUT_R, OUT_L and OUT_I). Avoid running the output traces between two ground layers or if traces must cross over on different layers, do it at 90 degrees.

ORDERING INFORMATION

Device	Marking	Package	Shipping†
NCP2809ADMR2	MAE	Micro10	4000 Tape & Reel
NCP2809ADMR2G	MAE	Micro10 (Pb–Free)	4000 Tape & Reel
NCP2809BDMR2	MAC	Micro10	4000 Tape & Reel
NCP2809BDMR2G	MAC	Micro10 (Pb–Free)	4000 Tape & Reel

†For information on tape and reel specifications, including part orientation and tape sizes, please refer to our Tape and Reel Packaging Specifications Brochure, BRD8011/D.

NCP2809 Series

PACKAGE DIMENSIONS

Micro10
CASE 846B-03
ISSUE D

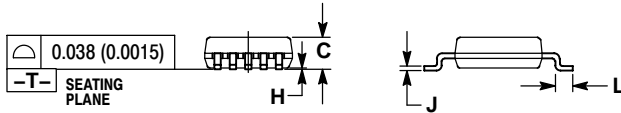
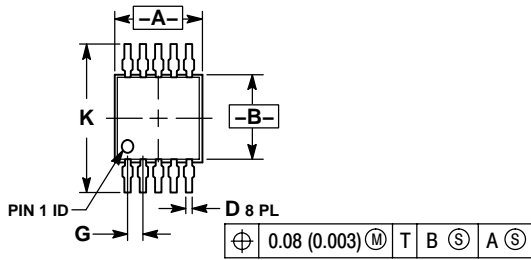

NOTES:

1. DIMENSIONING AND TOLERANCING PER ANSI Y14.5M, 1982.
2. CONTROLLING DIMENSION: MILLIMETER.
3. DIMENSION "A" DOES NOT INCLUDE MOLD FLASH, PROTRUSIONS OR GATE BURRS. MOLD FLASH, PROTRUSIONS OR GATE BURRS SHALL NOT EXCEED 0.15 (0.006) PER SIDE.
4. DIMENSION "B" DOES NOT INCLUDE INTERLEAD FLASH OR PROTRUSION. INTERLEAD FLASH OR PROTRUSION SHALL NOT EXCEED 0.25 (0.010) PER SIDE.
5. 846B-01 OBSOLETE. NEW STANDARD 846B-02

DIM	MILLIMETERS		INCHES	
	MIN	MAX	MIN	MAX
A	2.90	3.10	0.114	0.122
B	2.90	3.10	0.114	0.122
C	0.95	1.10	0.037	0.043
D	0.20	0.30	0.008	0.012
G	0.50 BSC		0.020 BSC	
H	0.05	0.15	0.002	0.006
J	0.10	0.21	0.004	0.008
K	4.75	5.05	0.187	0.199
L	0.40	0.70	0.016	0.028

SOLDERING FOOTPRINT*

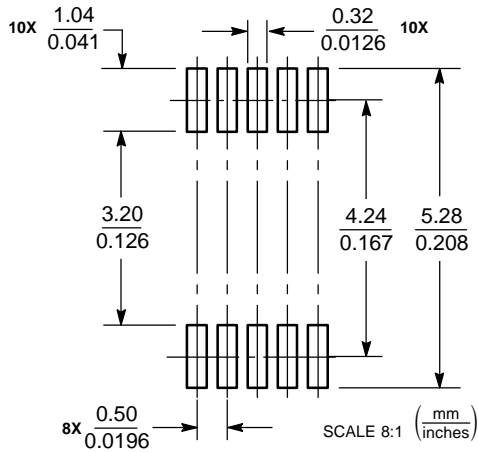

*For additional information on our Pb-Free strategy and soldering details, please download the ON Semiconductor Soldering and Mounting Techniques Reference Manual, SOLDERRM/D.

NCP2809 Series

NOCAP is a trademark of Semiconductor Components Industries, LLC (SCILLC).

ON Semiconductor and  are registered trademarks of Semiconductor Components Industries, LLC (SCILLC). SCILLC reserves the right to make changes without further notice to any products herein. SCILLC makes no warranty, representation or guarantee regarding the suitability of its products for any particular purpose, nor does SCILLC assume any liability arising out of the application or use of any product or circuit, and specifically disclaims any and all liability, including without limitation special, consequential or incidental damages. "Typical" parameters which may be provided in SCILLC data sheets and/or specifications can and do vary in different applications and actual performance may vary over time. All operating parameters, including "Typicals" must be validated for each customer application by customer's technical experts. SCILLC does not convey any license under its patent rights nor the rights of others. SCILLC products are not designed, intended, or authorized for use as components in systems intended for surgical implant into the body, or other applications intended to support or sustain life, or for any other application in which the failure of the SCILLC product could create a situation where personal injury or death may occur. Should Buyer purchase or use SCILLC products for any such unintended or unauthorized application, Buyer shall indemnify and hold SCILLC and its officers, employees, subsidiaries, affiliates, and distributors harmless against all claims, costs, damages, and expenses, and reasonable attorney fees arising out of, directly or indirectly, any claim of personal injury or death associated with such unintended or unauthorized use, even if such claim alleges that SCILLC was negligent regarding the design or manufacture of the part. SCILLC is an Equal Opportunity/Affirmative Action Employer. This literature is subject to all applicable copyright laws and is not for resale in any manner.

PUBLICATION ORDERING INFORMATION

LITERATURE FULFILLMENT:

Literature Distribution Center for ON Semiconductor
P.O. Box 61312, Phoenix, Arizona 85082-1312 USA
Phone: 480-829-7710 or 800-344-3860 Toll Free USA/Canada
Fax: 480-829-7709 or 800-344-3867 Toll Free USA/Canada
Email: orderlit@onsemi.com

N. American Technical Support: 800-282-9855 Toll Free
USA/Canada

Japan: ON Semiconductor, Japan Customer Focus Center
2-9-1 Kamimeguro, Meguro-ku, Tokyo, Japan 153-0051
Phone: 81-3-5773-3850

ON Semiconductor Website: <http://onsemi.com>

Order Literature: <http://www.onsemi.com/litorder>

For additional information, please contact your
local Sales Representative.