

JTDB 75

75 Watts, 36 Volts, Pulsed
Avionics 960 - 1215 MHz

GENERAL DESCRIPTION

The JTDB 75 is a high power COMMON BASE bipolar transistor. It is designed for pulsed systems in the frequency band 960-1215 MHz. The device has gold thin-film metallization and diffused ballasting for proven highest MTTF. The transistor includes input and output prematch for broadband capability. Low thermal resistance package reduces junction temperature, extends life.

ABSOLUTE MAXIMUM RATINGS

Maximum Power Dissipation @ 25°C² 220 Watts

Maximum Voltage and Current

BVces Collector to Base Voltage 55 Volts
BVebo Emitter to Base Voltage 3.5 Volts
Ic Collector Current 8.0 Amps

Maximum Temperatures

Storage Temperature - 65 to + 200°C
Operating Junction Temperature + 200°C

CASE OUTLINE 55AW, STYLE 1

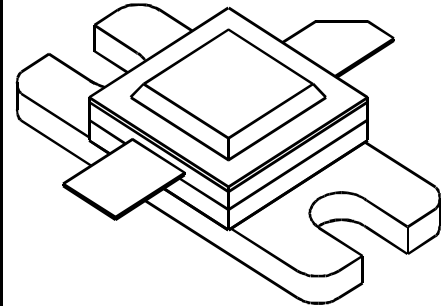

ELECTRICAL CHARACTERISTICS @ 25 °C

| SYMBOL | CHARACTERISTICS | TEST CONDITIONS | MIN | TYP | MAX | UNITS |
|----------------|-------------------------|------------------|-----|-----|-----|-------|
| Pout | Power Out | F = 960-1215 MHz | 75 | | | Watts |
| Pin | Power Input | Vcc = 36 Volts | | | 15 | Watts |
| Pg | Power Gain | PW = 10 μsec | 7.0 | 7.5 | | dB |
| η _c | Collector Efficiency | DF = 40% | | 40 | | % |
| VSWR | Load Mismatch Tolerance | F = 1090 MHz | | | 3:1 | |

| | | | | | | |
|------------------------------|--------------------------------|-----------------------|-----|--|-----|-------|
| BVebo | Emitter to Base Breakdown | Ie = 30mA | 3.5 | | | Volts |
| BVces | Collector to Emitter Breakdown | Ic = 30 mA | 55 | | | Volts |
| h _{FE} | DC - Current Gain | Ic = 25 mA, Vce = 5 V | 10 | | | |
| θ _{jc} ² | Thermal Resistance | | | | 0.8 | °C/W |

Note 1: At rated output power and pulse conditions

2: At rated pulse conditions

Issue A, July 1997

GHz TECHNOLOGY INC. RESERVES THE RIGHT TO MAKE CHANGES WITHOUT FURTHER NOTICE. GHz RECOMMENDS THAT BEFORE THE PRODUCT(S) DESCRIBED HEREIN ARE WRITTEN INTO SPECIFICATIONS, OR USED IN CRITICAL APPLICATIONS, THAT THE PERFORMANCE CHARACTERISTICS BE VERIFIED BY CONTACTING THE FACTORY.

GHz Technology Inc. 3000 Oakmead Village Drive, Santa Clara, CA 95051-0808 Tel. 408 / 986-8031 Fax 408 / 986-8120

All Data shown is for operation under the rated pulse conditions.

POWER OUTPUT vs FREQUENCY

V_{cc} = 36 V, P_{in} = 15 W

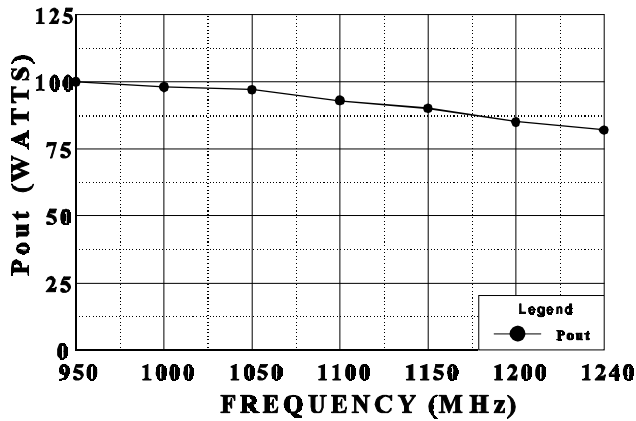

THERMAL RESISTANCE vs CASE TEMP.

V_{cc} = 36V, P_o = 75 W

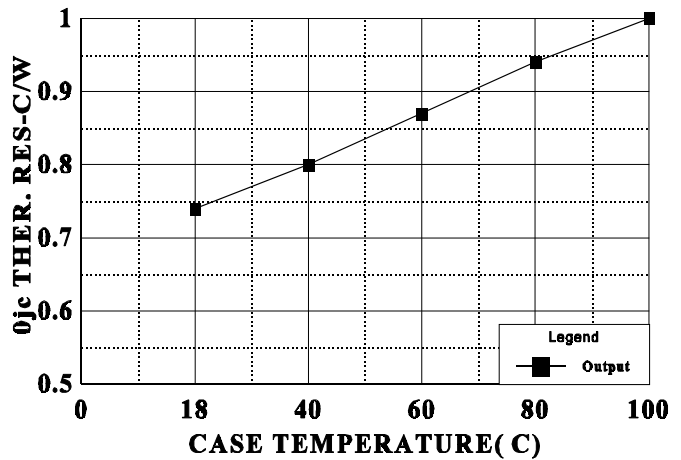

SERIES INPUT IMPEDANCE vs FREQUENCY

V_{cc} = 36 V, P_{in} = 13W Peak

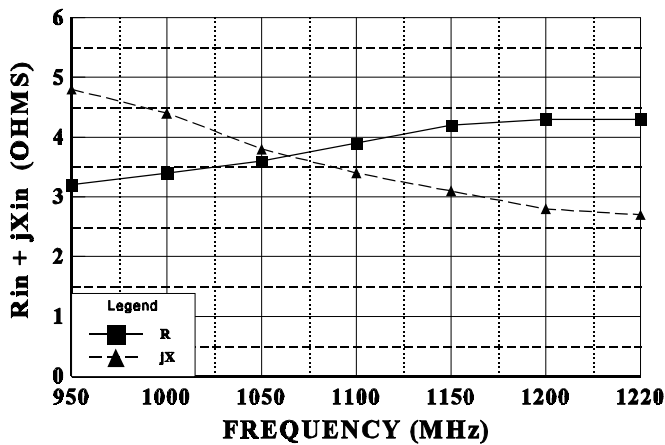

SERIES LOAD IMPEDANCE vs FREQUENCY

V_{cc} = 36 V, P_{in} = 13 W Peak

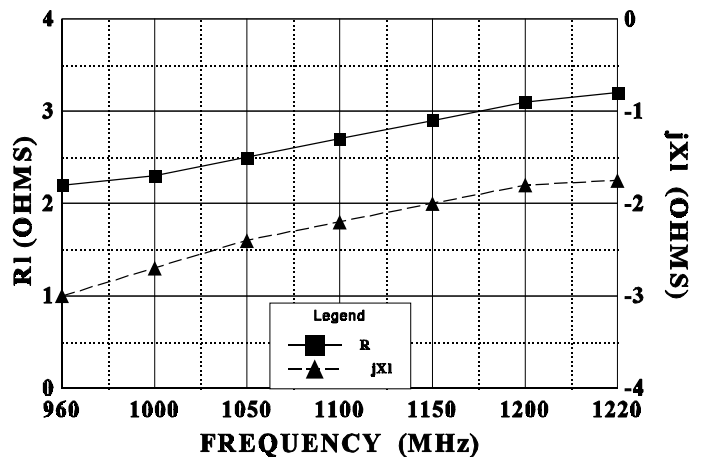

July 1997

GHz TECHNOLOGY INC. RESERVES THE RIGHT TO MAKE CHANGES WITHOUT FURTHER NOTICE. GHz RECOMMENDS THAT BEFORE THE PRODUCT(S) DESCRIBED HEREIN ARE WRITTEN INTO SPECIFICATIONS, OR USED IN CRITICAL APPLICATIONS, THAT THE PERFORMANCE CHARACTERISTICS BE VERIFIED BY CONTACTING THE FACTORY.

GHz Technology Inc. 3000 Oakmead Village Drive, Santa Clara, CA 95051-0808 Tel. 408 / 986-8031 Fax 408 / 986-8120

REVISIONS

| ZONE | REV | DESCRIPTION | DATE | APPROVED |
|------|-----|-------------|------|----------|
|------|-----|-------------|------|----------|

| DIM | INCHES |
|-----|--------|
| A | .675 |
| B | .200 |
| C | .150 |
| D | .028 |
| E | .575 |
| F | .245 |
| G | .325 |
| H | .500 |
| I | .175 |
| J | .700 |
| K | .250 |
| L | .650 |
| M | .580 |
| N | .230 |
| O | .150 |

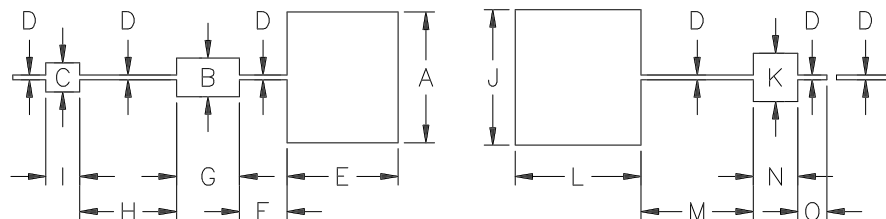

JTDB 75 TEST CIRCUIT

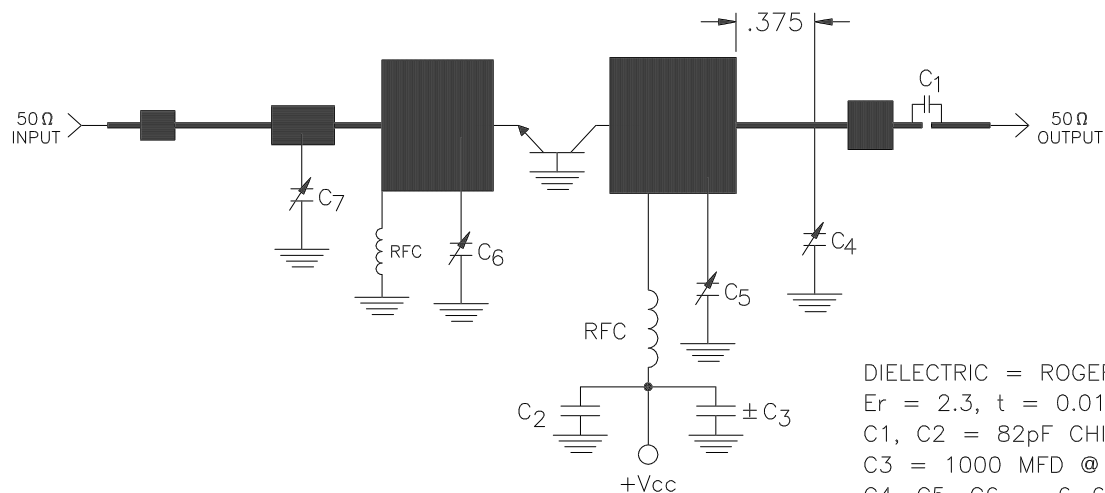

DIELECTRIC = ROGERS DUROID
 Er = 2.3, t = 0.010"
 C1, C2 = 82pF CHIP ATC "A"
 C3 = 1000 MFD @ 50V
 C4, C5, C6 = .6-6.5Pf Johanson
 C7 = 0.3-3.5Pf Johanson
 RFC = 5 turns #22 wire 1/16" I.D.



| | | | |
|---------------|---------|---------|----------|
| CAGE OPJR2 | DWG NO. | JTDB 75 | REV A |
| | SCALE | 1/1 | SHEET |