

# MITSUBISHI MICROCOMPUTERS

# M35047-XXXSP/FP

SCREEN CHARACTER and PATTERN DISPLAY CONTROLLERS

## DESCRIPTION

The M35047-XXXSP/FP is a character pattern display control IC can display on the CRT display the liquid crystal display and the plasma display. It uses a silicon gate CMOS process and it housed in a 20-pin shrink DIP package (M35047-XXXSP) or a 20-pin shrink SOP package (M35047-XXXFP).

For M35047-002SP/FP that is a standard ROM version of M35047-XXXSP/FP respectively, the character pattern is also mentioned.

## FEATURES

- Screen composition ..... 24 characters X 12 lines
- Number of characters displayed ..... 288 (Max.)
- Character composition ..... 12 X 18 dot matrix
- Characters available ..... ROM character:255 characters  
RAM character:8 characters
- Character sizes available ..... 4 (vertical) X 4 (horizontal)
- Display locations available
  - Horizontal direction ..... 2007 locations
  - Vertical direction ..... 2047 locations
- Blinking ..... Character units
  - Cycle : division of vertical synchronization signal into 32 or 64
  - Duty : 25%, 50%, or 75%
- Data input ..... By the I<sup>2</sup>C-BUS serial input function
- Coloring for ROM character
  - Character color ..... 8 colors (Character unit)
  - Background coloring ..... 8 colors (Character unit)
  - Border (shadow) coloring ..... 8 colors (unit of screen / character unit)
  - Raster coloring ..... 8 colors (unit of screen)
- Blanking for ROM character
  - Character size blanking
  - Border size blanking
  - Matrix-outline blanking
  - All blanking (all raster area)
- Coloring for RAM character ..... 8 colors (dot by dot)
- Blanking for RAM character
  - Character size blanking
  - Matrix-outline blanking
  - All blanking (all raster area)
- Output ports
  - 4 shared output ports (toggled between RGB output)
  - 4 dedicated output ports
- Display RAM erase function
- Display input frequency range ..... Fosc = 20.0MHz to 100.0MHz
- Horizontal synchronous input frequency
  - ..... H.sync = 15 kHz to 130 kHz
- Display oscillation stop function

## APPLICATION

CRT display, Liquid crystal display, Plasma display

## PIN CONFIGURATION (TOP VIEW)

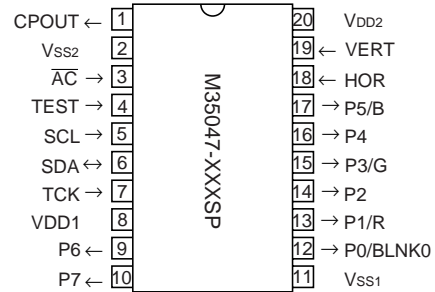

**Outline 20P4B**

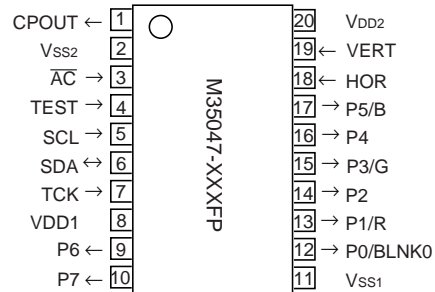

**Outline 20P2Q-A**

**PIN DESCRIPTION**

Pin Number	Symbol	Pin name	Input/Output	Function
1	CPOUT	Filter output	Output	Filter output. Connect loop filter to this pin.
2	Vss2	Earthing pin	–	Connect to GND.
3	$\overline{AC}$	Auto-clear input	Input	When "L", this pin resets the internal IC circuit. Hysteresis input. Built-in pull-up resistor.
4	TEST	Test input	Input	Test pin. Connect to +5V.
5	SCL	Clock input	Input	SDA pin serial data is taken in when SCL rises. Hysteresis input.
6	SDA	Data I/O	I/O	This is the pin for serial input of display control register and display RAM data. Also, this pin output acknowledge signal. Hysteresis input. Nch opendrain output.
7	TCK	External clock	Input	This is the pin for external clock input.
8	VDD1	Power pin	–	Please connect to +5V with the power pin.
9	P6	Port P6 output	Output	This is the output port.
10	P7	Port P7 output	Output	This is the output port.
11	Vss1	Earthing pin	–	Please connect to GND using circuit earthing pin.
12	P0/BLNK0	Port P0 output	Output	This pin can be toggled between port pin output and BLNK0 signal output.
13	P1/R	Port P1 output	Output	This pin can be toggled between port pin output and R signal output.
14	P2	Port P2 output	Output	This is the output port.
15	P3/G	Port P3 output	Output	This pin can be toggled between port pin output and G signal output.
16	P4	Port P4 output	Output	This is the output port.
17	P5/B	Port P5 output	Output	This pin can be toggled between port pin output and B signal output.
18	HOR	Horizontal synchronous signal input	Input	This pin inputs the horizontal synchronous signal. Hysteresis input.
19	VERT	Vertical synchronous signal input	Input	This pin inputs the vertical synchronous signal. Hysteresis input.
20	VDD2	Power pin	–	Please connect to +5V with the power pin.

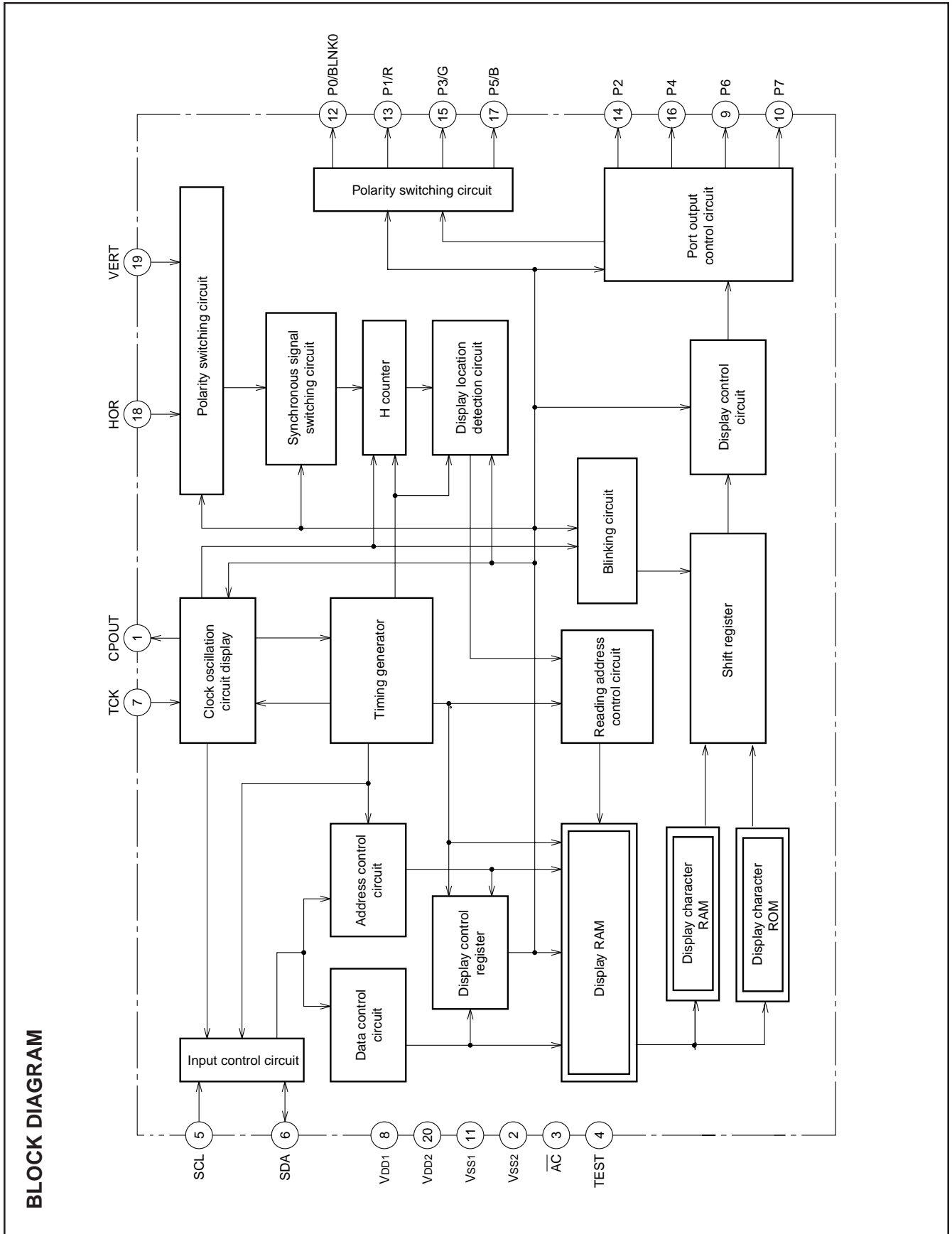

SCREEN CHARACTER and PATTERN DISPLAY CONTROLLERS

**MEMORY CONSTITUTION**

Address 000<sub>16</sub> to 11F<sub>16</sub> are assigned to the display RAM, address 120<sub>16</sub> to 129<sub>16</sub> are assigned to the display control registers and address 200<sub>16</sub> to 2F1<sub>16</sub> are assigned to the RAM characters. The internal circuit is reset and all display control registers (address 120<sub>16</sub> to 129<sub>16</sub>) are set to "0" when the AC pin level is "L". And

then, RAM is not erased and be undefined. For detail, see "DATA INPUT EXAMPLE". Memory constitution is shown in Figure 1 to 9.

Addresses	DAF	DAE	DAD	DAC	DAB	DAA	DA9	DA8	DA7	DA6	DA5	DA4	DA3	DA2	DA1	DA0
000 <sub>16</sub>	0	BB	BG	BR	BLINK	B	G	R	C7	C6	C5	C4	C3	C2	C1	C0
001 <sub>16</sub>	0	BB	BG	BR	BLINK	B	G	R	C7	C6	C5	C4	C3	C2	C1	C0
⋮	⋮	Background coloring			Blinking	Character color			Character code							
11E <sub>16</sub>	0	BB	BG	BR	BLINK	B	G	R	C7	C6	C5	C4	C3	C2	C1	C0
11F <sub>16</sub>	0	BB	BG	BR	BLINK	B	G	R	C7	C6	C5	C4	C3	C2	C1	C0
120 <sub>16</sub>	0	SPACE2	SPACE1	SPACE0	TEST10	DIV10	DIV9	DIV8	DIV7	DIV6	DIV5	DIV4	DIV3	DIV2	DIV1	DIV0
121 <sub>16</sub>	0	EXCK1	EXCK0	RSEL1	RSEL0	DIVS2	DIVS1	DIVS0	PTC7	PTC6	PTC5	PTC4	PTC3	PTC2	PTC1	PTC0
122 <sub>16</sub>	0	TEST17	TEST16	TEST15	TEST14	TEST13	TEST12	TEST11	PTD7	PTD6	PTD5	PTD4	PTD3	PTD2	PTD1	PTD0
123 <sub>16</sub>	0	TEST3	TEST2	TEST1	TEST0	HP10	HP9	HP8	HP7	HP6	HP5	HP4	HP3	HP2	HP1	HP0
124 <sub>16</sub>	0	TEST20	RBLK0	TEST19	TEST18	VP10	VP9	VP8	VP7	VP6	VP5	VP4	VP3	VP2	VP1	VP0
125 <sub>16</sub>	0	TEST23	TEST22	TEST21	DSP11	DSP10	DSP9	DSP8	DSP7	DSP6	DSP5	DSP4	DSP3	DSP2	DSP1	DSP0
126 <sub>16</sub>	0	TEST24	VSZ1H1	VSZ1H0	VSZ1L1	VSZ1L0	V1SZ1	V1SZ0	LIN9	LIN8	LIN7	LIN6	LIN5	LIN4	LIN3	LIN2
127 <sub>16</sub>	0	TEST25	VSZ2H1	VSZ2H0	VSZ2L1	VSZ2L0	V18SZ1	V18SZ0	LIN17	LIN16	LIN15	LIN14	LIN13	LIN12	LIN11	LIN10
128 <sub>16</sub>	0	TEST29	HSZ21	HSZ20	HSZ11	HSZ10	BETA14	TEST28	TEST27	TEST26	FB	FG	FR	RB	RG	RR
129 <sub>16</sub>	0	TEST30	BLINK2	BLINK1	BLINK0	DSPON	STOP	RAMERS	SYAD	BLK1	BLK0	POLH	POLV	VMASK	B/F	BCOL

Fig.1 Memory constitution (Display RAM, Display Control register)

SCREEN CHARACTER and PATTERN DISPLAY CONTROLLERS

Address	DAF	DAE	DAD	DAC	DAB	DAA	DA9	DA8	DA7	DA6	DA5	DA4	DA3	DA2	DA1	DA0
200 <sub>16</sub>	0	BS	GS	RS	FR000B	FR000A	FR0009	FR0008	FR0007	FR0009	FR0005	FR0004	FR0003	FR0002	FR0001	FR0000
201 <sub>16</sub>	0	BS	GS	RS	FR001B	FR001A	FR0019	FR0018	FR0017	FR0019	FR0015	FR0014	FR0013	FR0012	FR0011	FR0010
202 <sub>16</sub>	0	BS	GS	RS	FR002B	FR002A	FR0029	FR0028	FR0027	FR0026	FR0025	FR0024	FR0023	FR0022	FR0021	FR0020
203 <sub>16</sub>	0	BS	GS	RS	FR003B	FR003A	FR0039	FR0038	FR0037	FR0036	FR0035	FR0034	FR0033	FR0032	FR0031	FR0030
204 <sub>16</sub>	0	BS	GS	RS	FR004B	FR004A	FR0049	FR0048	FR0047	FR0046	FR0045	FR0044	FR0043	FR0042	FR0041	FR0040
205 <sub>16</sub>	0	BS	GS	RS	FR005B	FR005A	FR0059	FR0058	FR0057	FR0056	FR0055	FR0054	FR0053	FR0052	FR0051	FR0050
206 <sub>16</sub>	0	BS	GS	RS	FR006B	FR006A	FR0069	FR0068	FR0067	FR0066	FR0065	FR0064	FR0063	FR0062	FR0061	FR0060
207 <sub>16</sub>	0	BS	GS	RS	FR007B	FR007A	FR0079	FR0078	FR0077	FR0076	FR0075	FR0074	FR0073	FR0072	FR0071	FR0070
208 <sub>16</sub>	0	BS	GS	RS	FR008B	FR008A	FR0089	FR0088	FR0087	FR0086	FR0085	FR0084	FR0083	FR0082	FR0081	FR0080
209 <sub>16</sub>	0	BS	GS	RS	FR009B	FR009A	FR0099	FR0098	FR0097	FR0096	FR0095	FR0094	FR0093	FR0092	FR0091	FR0090
20A <sub>16</sub>	0	BS	GS	RS	FR00AB	FR00AA	FR00A9	FR00A8	FR00A7	FR00A6	FR00A5	FR00A4	FR00A3	FR00A2	FR00A1	FR00A0
20B <sub>16</sub>	0	BS	GS	RS	FR00BB	FR00BA	FR00B9	FR00B8	FR00B7	FR00B6	FR00B5	FR00B4	FR00B3	FR00B2	FR00B1	FR00B0
20C <sub>16</sub>	0	BS	GS	RS	FR00CB	FR00CA	FR00C9	FR00C8	FR00C7	FR00C6	FR00C5	FR00C4	FR00C3	FR00C2	FR00C1	FR00C0
20D <sub>16</sub>	0	BS	GS	RS	FR00DB	FR00DA	FR00D9	FR00D8	FR00D7	FR00D6	FR00D5	FR00D4	FR00D3	FR00D2	FR00D1	FR00D0
20E <sub>16</sub>	0	BS	GS	RS	FR00EB	FR00EA	FR00E9	FR00E8	FR00E7	FR00E6	FR00E5	FR00E4	FR00E3	FR00E2	FR00E1	FR00E0
20F <sub>16</sub>	0	BS	GS	RS	FR00FB	FR00FA	FR00F9	FR00F8	FR00F7	FR00F6	FR00F5	FR00F4	FR00F3	FR00F2	FR00F1	FR00F0
210 <sub>16</sub>	0	BS	GS	RS	FR010B	FR010A	FR0109	FR0108	FR0107	FR0106	FR0105	FR0104	FR0103	FR0102	FR0101	FR0100
211 <sub>16</sub>	0	BS	GS	RS	FR011B	FR011A	FR0119	FR0118	FR0117	FR0116	FR0115	FR0114	FR0113	FR0112	FR0111	FR0110
212 <sub>16</sub> ⋮ 21F <sub>16</sub>	Can not be used															

Fig.2 Memory constitution (RAM character 0)

Address	DAF	DAE	DAD	DAC	DAB	DAA	DA9	DA8	DA7	DA6	DA5	DA4	DA3	DA2	DA1	DA0
220 <sub>16</sub>	0	BS	GS	RS	FR100B	FR100A	FR1009	FR1008	FR1007	FR1006	FR1005	FR1004	FR1003	FR1002	FR1001	FR1000
221 <sub>16</sub> ⋮ 230 <sub>16</sub>	RAM character 1 data															
231 <sub>16</sub>	0	BS	GS	RS	FR111B	FR111A	FR1119	FR1118	FR1117	FR1116	FR1115	FR1114	FR1113	FR1112	FR1111	FR1110
232 <sub>16</sub> ⋮ 23F <sub>16</sub>	Can not be used															

Fig.3 Memory constitution (RAM character 1)

SCREEN CHARACTER and PATTERN DISPLAY CONTROLLERS

Address	DAF	DAE	DAD	DAC	DAB	DAA	DA9	DA8	DA7	DA6	DA5	DA4	DA3	DA2	DA1	DA0
240 <sub>16</sub>	0	BS	GS	RS	FR200B	FR200A	FR2009	FR2008	FR2007	FR2006	FR2005	FR2004	FR2003	FR2002	FR2001	FR2000
241 <sub>16</sub> ⋮ 250 <sub>16</sub>	RAM character 2 data															
251 <sub>16</sub>	0	BS	GS	RS	FR211B	FR211A	FR2119	FR2118	FR2117	FR2116	FR2115	FR2114	FR2113	FR2112	FR2111	FR2110
252 <sub>16</sub> ⋮ 25F <sub>16</sub>	Can not be used															

**Fig.4 Memory constitution (RAM character 2)**

Address	DAF	DAE	DAD	DAC	DAB	DAA	DA9	DA8	DA7	DA6	DA5	DA4	DA3	DA2	DA1	DA0
260 <sub>16</sub>	0	BS	GS	RS	FR300B	FR300A	FR3009	FR3008	FR3007	FR3006	FR3005	FR3004	FR3003	FR3002	FR3001	FR3000
261 <sub>16</sub> ⋮ 270 <sub>16</sub>	RAM character 3 data															
271 <sub>16</sub>	0	BS	GS	RS	FR311B	FR311A	FR3119	FR3118	FR3117	FR3116	FR3115	FR3114	FR3113	FR3112	FR3111	FR3110
272 <sub>16</sub> ⋮ 27F <sub>16</sub>	Can not be used															

**Fig.5 Memory constitution (RAM character 3)**

Address	DAF	DAE	DAD	DAC	DAB	DAA	DA9	DA8	DA7	DA6	DA5	DA4	DA3	DA2	DA1	DA0
280 <sub>16</sub>	0	BS	GS	RS	FR400B	FR400A	FR4009	FR4008	FR4007	FR4006	FR4005	FR4004	FR4003	FR4002	FR4001	FR4000
281 <sub>16</sub> ⋮ 290 <sub>16</sub>	RAM character 4 data															
291 <sub>16</sub>	0	BS	GS	RS	FR411B	FR411A	FR4119	FR4118	FR4117	FR4116	FR4115	FR4114	FR4113	FR4112	FR4111	FR4510
292 <sub>16</sub> ⋮ 29F <sub>16</sub>	Can not be used															

**Fig.6 Memory constitution (RAM character 4)**

SCREEN CHARACTER and PATTERN DISPLAY CONTROLLERS

Address	DAF	DAE	DAD	DAC	DAB	DAA	DA9	DA8	DA7	DA6	DA5	DA4	DA3	DA2	DA1	D00
2A0 <sub>16</sub>	0	BS	GS	RS	FR500B	FR500A	FR5009	FR5008	FR5007	FR5006	FR5005	FR5004	FR5003	FR5002	FR5001	FR5000
2A1 <sub>16</sub> ⋮ 2B0 <sub>16</sub>	RAM character 5 data															
2B1 <sub>16</sub>	0	BS	GS	RS	FR511B	FR511A	FR5119	FR5118	FR5117	FR5116	FR5115	FR5114	FR5113	FR5112	FR5111	FR5110
2B2 <sub>16</sub> ⋮ 2BF <sub>16</sub>	Can not be used															

**Fig.7 Memory constitution (RAM character 5)**

Address	DAF	DAE	DAD	DAC	DAB	DAA	DA9	DA8	DA7	DA6	DA5	DA4	DA3	DA2	DA1	DA0
2C0 <sub>16</sub>	0	BS	GS	RS	FR600B	FR600A	FR6009	FR6008	FR6007	FR6006	FR6005	FR6004	FR6003	FR6002	FR6001	FR6000
2C1 <sub>16</sub> ⋮ 2D0 <sub>16</sub>	RAM character 6 data															
2D1 <sub>16</sub>	0	BS	GS	RS	FR611B	FR611A	FR6119	FR6118	FR6117	FR6116	FR6115	FR6114	FR6113	FR6112	FR6111	FR6110
2D2 <sub>16</sub> ⋮ 2DF <sub>16</sub>	Can not be used															

**Fig.8 Memory constitution (RAM character 6)**

Address	DAF	DAE	DAD	DAC	DAB	DAA	DA9	DA8	DA7	DA6	DA5	DA4	DA3	DA2	DA1	DA0
2E0 <sub>16</sub>	0	BS	GS	RS	FR700B	FR700A	FR7009	FR7008	FR7007	FR7006	FR7005	FR7004	FR7003	FR7002	FR7001	FR7000
2E1 <sub>16</sub> ⋮ 2F0 <sub>16</sub>	RAM character 7 data															
2F1 <sub>16</sub>	0	BS	GS	RS	FR711B	FR711A	FR7119	FR7118	FR7117	FR7116	FR7115	FR7114	FR7113	FR7112	FR7111	FR7110

**Fig.9 Memory constitution (RAM character 7)**

SCREEN CHARACTER and PATTERN DISPLAY CONTROLLERS

**SCREEN CONSTITUTION**

The screen lines and rows are determined from each address of the display RAM . The screen constitution is shown in Figure 10.

Row Line	1	2	3	4	5	6	7	8	9	10	11	12	13	14	15	16	17	18	19	20	21	22	23	24
1	000 <sub>16</sub>	001 <sub>16</sub>	002 <sub>16</sub>	003 <sub>16</sub>	004 <sub>16</sub>	005 <sub>16</sub>	006 <sub>16</sub>	007 <sub>16</sub>	008 <sub>16</sub>	009 <sub>16</sub>	00A <sub>16</sub>	00B <sub>16</sub>	00C <sub>16</sub>	00D <sub>16</sub>	00E <sub>16</sub>	00F <sub>16</sub>	010 <sub>16</sub>	011 <sub>16</sub>	012 <sub>16</sub>	013 <sub>16</sub>	014 <sub>16</sub>	015 <sub>16</sub>	016 <sub>16</sub>	017 <sub>16</sub>
2	018 <sub>16</sub>	019 <sub>16</sub>	01A <sub>16</sub>	01B <sub>16</sub>	01C <sub>16</sub>	01D <sub>16</sub>	01E <sub>16</sub>	01F <sub>16</sub>	020 <sub>16</sub>	021 <sub>16</sub>	022 <sub>16</sub>	023 <sub>16</sub>	024 <sub>16</sub>	025 <sub>16</sub>	026 <sub>16</sub>	027 <sub>16</sub>	028 <sub>16</sub>	029 <sub>16</sub>	02A <sub>16</sub>	02B <sub>16</sub>	02C <sub>16</sub>	02D <sub>16</sub>	02E <sub>16</sub>	02F <sub>16</sub>
3	030 <sub>16</sub>	031 <sub>16</sub>	032 <sub>16</sub>	033 <sub>16</sub>	034 <sub>16</sub>	035 <sub>16</sub>	036 <sub>16</sub>	037 <sub>16</sub>	038 <sub>16</sub>	039 <sub>16</sub>	03A <sub>16</sub>	03B <sub>16</sub>	03C <sub>16</sub>	03D <sub>16</sub>	03E <sub>16</sub>	03F <sub>16</sub>	040 <sub>16</sub>	041 <sub>16</sub>	042 <sub>16</sub>	043 <sub>16</sub>	044 <sub>16</sub>	045 <sub>16</sub>	046 <sub>16</sub>	047 <sub>16</sub>
4	048 <sub>16</sub>	049 <sub>16</sub>	04A <sub>16</sub>	04B <sub>16</sub>	04C <sub>16</sub>	04D <sub>16</sub>	04E <sub>16</sub>	04F <sub>16</sub>	050 <sub>16</sub>	051 <sub>16</sub>	052 <sub>16</sub>	053 <sub>16</sub>	054 <sub>16</sub>	055 <sub>16</sub>	056 <sub>16</sub>	057 <sub>16</sub>	058 <sub>16</sub>	059 <sub>16</sub>	05A <sub>16</sub>	05B <sub>16</sub>	05C <sub>16</sub>	05D <sub>16</sub>	05E <sub>16</sub>	05F <sub>16</sub>
5	060 <sub>16</sub>	061 <sub>16</sub>	062 <sub>16</sub>	063 <sub>16</sub>	064 <sub>16</sub>	065 <sub>16</sub>	066 <sub>16</sub>	067 <sub>16</sub>	068 <sub>16</sub>	069 <sub>16</sub>	06A <sub>16</sub>	06B <sub>16</sub>	06C <sub>16</sub>	06D <sub>16</sub>	06E <sub>16</sub>	06F <sub>16</sub>	070 <sub>16</sub>	071 <sub>16</sub>	072 <sub>16</sub>	073 <sub>16</sub>	074 <sub>16</sub>	075 <sub>16</sub>	076 <sub>16</sub>	077 <sub>16</sub>
6	078 <sub>16</sub>	079 <sub>16</sub>	07A <sub>16</sub>	07B <sub>16</sub>	07C <sub>16</sub>	07D <sub>16</sub>	07E <sub>16</sub>	07F <sub>16</sub>	080 <sub>16</sub>	081 <sub>16</sub>	082 <sub>16</sub>	083 <sub>16</sub>	084 <sub>16</sub>	085 <sub>16</sub>	086 <sub>16</sub>	087 <sub>16</sub>	088 <sub>16</sub>	089 <sub>16</sub>	08A <sub>16</sub>	08B <sub>16</sub>	08C <sub>16</sub>	08D <sub>16</sub>	08E <sub>16</sub>	08F <sub>16</sub>
7	090 <sub>16</sub>	091 <sub>16</sub>	092 <sub>16</sub>	093 <sub>16</sub>	094 <sub>16</sub>	095 <sub>16</sub>	096 <sub>16</sub>	097 <sub>16</sub>	098 <sub>16</sub>	099 <sub>16</sub>	09A <sub>16</sub>	09B <sub>16</sub>	09C <sub>16</sub>	09D <sub>16</sub>	09E <sub>16</sub>	09F <sub>16</sub>	0A0 <sub>16</sub>	0A1 <sub>16</sub>	0A2 <sub>16</sub>	0A3 <sub>16</sub>	0A4 <sub>16</sub>	0A5 <sub>16</sub>	0A6 <sub>16</sub>	0A7 <sub>16</sub>
8	0A8 <sub>16</sub>	0A9 <sub>16</sub>	0AA <sub>16</sub>	0AB <sub>16</sub>	0AC <sub>16</sub>	0AD <sub>16</sub>	0AE <sub>16</sub>	0AF <sub>16</sub>	0B0 <sub>16</sub>	0B1 <sub>16</sub>	0B2 <sub>16</sub>	0B3 <sub>16</sub>	0B4 <sub>16</sub>	0B5 <sub>16</sub>	0B6 <sub>16</sub>	0B7 <sub>16</sub>	0B8 <sub>16</sub>	0B9 <sub>16</sub>	0BA <sub>16</sub>	0BB <sub>16</sub>	0BC <sub>16</sub>	0BD <sub>16</sub>	0BE <sub>16</sub>	0BF <sub>16</sub>
9	0C0 <sub>16</sub>	0C1 <sub>16</sub>	0C2 <sub>16</sub>	0C3 <sub>16</sub>	0C4 <sub>16</sub>	0C5 <sub>16</sub>	0C6 <sub>16</sub>	0C7 <sub>16</sub>	0C8 <sub>16</sub>	0C9 <sub>16</sub>	0CA <sub>16</sub>	0CB <sub>16</sub>	0CC <sub>16</sub>	0CD <sub>16</sub>	0CE <sub>16</sub>	0CF <sub>16</sub>	0D0 <sub>16</sub>	0D1 <sub>16</sub>	0D2 <sub>16</sub>	0D3 <sub>16</sub>	0D4 <sub>16</sub>	0D5 <sub>16</sub>	0D6 <sub>16</sub>	0D7 <sub>16</sub>
10	0D8 <sub>16</sub>	0D9 <sub>16</sub>	0DA <sub>16</sub>	0DB <sub>16</sub>	0DC <sub>16</sub>	0DD <sub>16</sub>	0DE <sub>16</sub>	0DF <sub>16</sub>	0E0 <sub>16</sub>	0E1 <sub>16</sub>	0E2 <sub>16</sub>	0E3 <sub>16</sub>	0E4 <sub>16</sub>	0E5 <sub>16</sub>	0E6 <sub>16</sub>	0E7 <sub>16</sub>	0E8 <sub>16</sub>	0E9 <sub>16</sub>	0EA <sub>16</sub>	0EB <sub>16</sub>	0EC <sub>16</sub>	0ED <sub>16</sub>	0EE <sub>16</sub>	0EF <sub>16</sub>
11	0F0 <sub>16</sub>	0F1 <sub>16</sub>	0F2 <sub>16</sub>	0F3 <sub>16</sub>	0F4 <sub>16</sub>	0F5 <sub>16</sub>	0F6 <sub>16</sub>	0F7 <sub>16</sub>	0F8 <sub>16</sub>	0F9 <sub>16</sub>	0FA <sub>16</sub>	0FB <sub>16</sub>	0FC <sub>16</sub>	0FD <sub>16</sub>	0FE <sub>16</sub>	0FF <sub>16</sub>	100 <sub>16</sub>	101 <sub>16</sub>	102 <sub>16</sub>	103 <sub>16</sub>	104 <sub>16</sub>	105 <sub>16</sub>	106 <sub>16</sub>	107 <sub>16</sub>
12	108 <sub>16</sub>	109 <sub>16</sub>	10A <sub>16</sub>	10B <sub>16</sub>	10C <sub>16</sub>	10D <sub>16</sub>	10E <sub>16</sub>	10F <sub>16</sub>	110 <sub>16</sub>	111 <sub>16</sub>	112 <sub>16</sub>	113 <sub>16</sub>	114 <sub>16</sub>	115 <sub>16</sub>	116 <sub>16</sub>	117 <sub>16</sub>	118 <sub>16</sub>	119 <sub>16</sub>	11A <sub>16</sub>	11B <sub>16</sub>	11C <sub>16</sub>	11D <sub>16</sub>	11E <sub>16</sub>	11F <sub>16</sub>

\* The hexadecimal numbers in the boxes show the display RAM address.

Fig.10 Screen constitution

**RAM Character CONSTITUTION**

The dot lines and dot rows of the character RAM are determined from each address and bit of the character RAM . The RAM character constitution is shown in Figure 11.

Dot Dot	1	2	3	4	5	6	7	8	9	10	11	12
1	FRn00B	FRn00A	FRn009	FRn008	FRn007	FRn006	FRn005	FRn004	FRn003	FRn002	FRn001	FRn000
2	FRn01B	FRn01A	FRn019	FRn018	FRn017	FRn016	FRn015	FRn014	FRn013	FRn012	FRn011	FRn010
3	FRn02B	FRn02A	FRn029	FRn028	FRn027	FRn026	FRn025	FRn024	FRn023	FRn022	FRn021	FRn020
4	FRn03B	FRn03A	FRn039	FRn038	FRn037	FRn036	FRn035	FRn034	FRn033	FRn032	FRn031	FRn030
5	FRn04B	FRn04A	FRn049	FRn048	FRn047	FRn046	FRn045	FRn044	FRn043	FRn042	FRn041	FRn040
6	FRn05B	FRn05A	FRn059	FRn058	FRn057	FRn056	FRn055	FRn054	FRn053	FRn052	FRn051	FRn050
7	FRn06B	FRn06A	FRn069	FRn068	FRn067	FRn066	FRn065	FRn064	FRn063	FRn062	FRn061	FRn060
8	FRn07B	FRn07A	FRn079	FRn078	FRn077	FRn076	FRn075	FRn074	FRn073	FRn072	FRn071	FRn070
9	FRn08B	FRn08A	FRn089	FRn088	FRn087	FRn086	FRn085	FRn084	FRn083	FRn082	FRn081	FRn080
10	FRn09B	FRn09A	FRn099	FRn098	FRn097	FRn096	FRn095	FRn094	FRn093	FRn092	FRn091	FRn090
11	FRn0AB	FRn0AA	FRn0A9	FRn0A8	FRn0A7	FRn0A6	FRn0A5	FRn0A4	FRn0A3	FRn0A2	FRn0A1	FRn0A0
12	FRn0BB	FRn0BA	FRn0B9	FRn0B8	FRn0B7	FRn0B6	FRn0B5	FRn0B4	FRn0B3	FRn0B2	FRn0B1	FRn0B0
13	FRn0CB	FRn0CA	FRn0C9	FRn0C8	FRn0C7	FRn0C6	FRn0C5	FRn0C4	FRn0C3	FRn0C2	FRn0C1	FRn0C0
14	FRn0DB	FRn0DA	FRn0D9	FRn0D8	FRn0D7	FRn0D6	FRn0D5	FRn0D4	FRn0D3	FRn0D2	FRn0D1	FRn0D0
15	FRn0EB	FRn0EA	FRn0E9	FRn0E8	FRn0E7	FRn0E6	FRn0E5	FRn0E4	FRn0E3	FRn0E2	FRn0E1	FRn0E0
16	FRn0FB	FRn0FA	FRn0F9	FRn0F8	FRn0F7	FRn0F6	FRn0F5	FRn0F4	FRn0F3	FRn0F2	FRn0F1	FRn0F0
17	FRn10B	FRn10A	FRn109	FRn108	FRn107	FRn106	FRn105	FRn104	FRn103	FRn102	FRn101	FRn100
18	FRn11B	FRn11A	FRn119	FRn118	FRn117	FRn116	FRn115	FRn114	FRn113	FRn112	FRn111	FRn110

\* The number in the boxes show the bit address of the RAM character : n. ("n" is RAM number : 0 to 7)

Fig.11 RAM character constitution

Note. When the RAM character is used, it is necessary to clear all areas of the RAM character first.



SCREEN CHARACTER and PATTERN DISPLAY CONTROLLERS

**DISPLAY RAM**

Address 000<sub>16</sub> to 11F<sub>16</sub>

DA	Register	Contents		Remarks																																				
		Status	Function																																					
0	C0	0	Set the displayed ROM character code.  *RAM character is selected using the 8 bits from C7 to C0. When C7 to C0=(11111110 <sub>2</sub> ) is set. And, RAM character code is set to R, G and B.	Set display character																																				
		1																																						
1	C1	0																																						
		1																																						
2	C2	0																																						
		1																																						
3	C3	0																																						
		1																																						
4	C4	0																																						
		1																																						
5	C5	0																																						
		1																																						
6	C6	0																																						
		1																																						
7	C7	0																																						
		1																																						
8	R	0	<table border="1"> <thead> <tr> <th>B</th> <th>G</th> <th>R</th> <th>RAM character code</th> </tr> </thead> <tbody> <tr><td>0</td><td>0</td><td>0</td><td>RAM character 0</td></tr> <tr><td>0</td><td>0</td><td>1</td><td>RAM character 1</td></tr> <tr><td>0</td><td>1</td><td>0</td><td>RAM character 2</td></tr> <tr><td>0</td><td>1</td><td>1</td><td>RAM character 3</td></tr> <tr><td>1</td><td>0</td><td>0</td><td>RAM character 4</td></tr> <tr><td>1</td><td>0</td><td>1</td><td>RAM character 5</td></tr> <tr><td>1</td><td>1</td><td>0</td><td>RAM character 6</td></tr> <tr><td>1</td><td>1</td><td>1</td><td>RAM character 7</td></tr> </tbody> </table>	B	G	R	RAM character code	0	0	0	RAM character 0	0	0	1	RAM character 1	0	1	0	RAM character 2	0	1	1	RAM character 3	1	0	0	RAM character 4	1	0	1	RAM character 5	1	1	0	RAM character 6	1	1	1	RAM character 7	Set character color (character unit) * When set C7 to C0=(11111110 <sub>2</sub> ), can be set RAM character code.
		B		G	R	RAM character code																																		
0	0	0		RAM character 0																																				
0	0	1		RAM character 1																																				
0	1	0		RAM character 2																																				
0	1	1		RAM character 3																																				
1	0	0		RAM character 4																																				
1	0	1		RAM character 5																																				
1	1	0		RAM character 6																																				
1	1	1		RAM character 7																																				
1																																								
9	G	0																																						
		1																																						
A	B	0																																						
		1																																						
B	BLINK	0		Do not blink.	Set blinking See register BLINK2 to BLINK0 (address 129 <sub>16</sub> )																																			
		1	Blinking																																					
C	BR	0	<table border="1"> <thead> <tr> <th>BB</th> <th>BG</th> <th>BR</th> <th>Color</th> </tr> </thead> <tbody> <tr><td>0</td><td>0</td><td>0</td><td>Black</td></tr> <tr><td>0</td><td>0</td><td>1</td><td>Red</td></tr> <tr><td>0</td><td>1</td><td>0</td><td>Green</td></tr> <tr><td>0</td><td>1</td><td>1</td><td>Yellow</td></tr> <tr><td>1</td><td>0</td><td>0</td><td>Blue</td></tr> <tr><td>1</td><td>0</td><td>1</td><td>Magenta</td></tr> <tr><td>1</td><td>1</td><td>0</td><td>Cyan</td></tr> <tr><td>1</td><td>1</td><td>1</td><td>White</td></tr> </tbody> </table>	BB	BG	BR	Color	0	0	0	Black	0	0	1	Red	0	1	0	Green	0	1	1	Yellow	1	0	0	Blue	1	0	1	Magenta	1	1	0	Cyan	1	1	1	White	Set character background color. (character unit) * When set C7 to C0=(11111110 <sub>2</sub> ) and register RBLK0 (address 124 <sub>16</sub> )= "1", set coloring prohibition color. Moreover, when the blink is set, the parts other than the color set by this register are blinks. See DISPLAY FORM 2.
		BB		BG	BR	Color																																		
0	0	0		Black																																				
0	0	1		Red																																				
0	1	0		Green																																				
0	1	1		Yellow																																				
1	0	0		Blue																																				
1	0	1		Magenta																																				
1	1	0		Cyan																																				
1	1	1		White																																				
1																																								
D	BG	0																																						
		1																																						
E	BB	0																																						
		1																																						

Note. The display RAM is undefined state at the AC pin.

**REGISTERS DESCRIPTION**

(1) Address 120<sub>16</sub>

DA	Register	Contents		Remarks																																			
		Status	Function																																				
0	DIV0	0	Set division value (multiply value) of horizontal oscillation frequency.	Set display frequency by division value (multiply value) setting. For details, see REGISTER SUPPLEMENTARY DESCRIPTION (1).  Also, set the display frequency range by registers DIVS0, DIVS1, DIVS2, RSEL0 and RSEL1(address 121 <sub>16</sub> ) in accordance with the display frequency.  Any of this settings above is required only when EXCK1 = 0, EXCK0 = 1 and EXCK1 = 1, EXCK0 = 1.																																			
		1																																					
1	DIV1	0	$N1 = \sum_{n=0}^{10} (DIVn \times 2^n)$ N1 : division value (multiply value)																																				
		1																																					
2	DIV2	0																																					
		1																																					
3	DIV3	0																																					
		1																																					
4	DIV4	0																																					
		1																																					
5	DIV5	0																																					
		1																																					
6	DIV6	0																																					
		1																																					
7	DIV7	0																																					
		1																																					
8	DIV8	0																																					
		1																																					
9	DIV9	0																																					
		1																																					
A	DIV10	0																																					
		1																																					
B	TEST10	0	It should be fixed to "0".																																				
		1	Can not be used.																																				
C	SPACE0	0	<table border="1" style="margin-left: auto; margin-right: auto;"> <thead> <tr> <th colspan="3">SPACE</th> <th>Number of Lines and Space &lt;(S) represents space&gt;</th> </tr> </thead> <tbody> <tr> <td>2</td> <td>1</td> <td>0</td> <td>12</td> </tr> <tr> <td>0</td> <td>0</td> <td>0</td> <td>1 (S) 10 (S) 1</td> </tr> <tr> <td>0</td> <td>0</td> <td>1</td> <td>2 (S) 8 (S) 2</td> </tr> <tr> <td>0</td> <td>1</td> <td>0</td> <td>3 (S) 6 (S) 3</td> </tr> <tr> <td>1</td> <td>0</td> <td>0</td> <td>4 (S) 4 (S) 4</td> </tr> <tr> <td>1</td> <td>0</td> <td>1</td> <td>5 (S) 2 (S) 5</td> </tr> <tr> <td>1</td> <td>1</td> <td>0</td> <td>6 (S) 6</td> </tr> <tr> <td>1</td> <td>1</td> <td>1</td> <td>6 (S)(S) 6</td> </tr> </tbody> </table> (S) represents one line worth of space	SPACE			Number of Lines and Space <(S) represents space>	2	1	0	12	0	0	0	1 (S) 10 (S) 1	0	0	1	2 (S) 8 (S) 2	0	1	0	3 (S) 6 (S) 3	1	0	0	4 (S) 4 (S) 4	1	0	1	5 (S) 2 (S) 5	1	1	0	6 (S) 6	1	1	1	6 (S)(S) 6
		SPACE			Number of Lines and Space <(S) represents space>																																		
2	1	0		12																																			
0	0	0		1 (S) 10 (S) 1																																			
0	0	1		2 (S) 8 (S) 2																																			
0	1	0		3 (S) 6 (S) 3																																			
1	0	0		4 (S) 4 (S) 4																																			
1	0	1		5 (S) 2 (S) 5																																			
1	1	0		6 (S) 6																																			
1	1	1		6 (S)(S) 6																																			
1																																							
D	SPACE1	0																																					
		1																																					
E	SPACE2	0																																					
		1																																					

Note. The mark 0 around the status value means the reset status by the "L" level is input to AC pin.

SCREEN CHARACTER and PATTERN DISPLAY CONTROLLERS

(2) Address 121<sub>16</sub>

DA	Register	Contents		Remarks															
		Status	Function																
0	PTC0	0	P0 output (port P0).	P0 pin output control.															
		1	BLNK0 output.																
1	PTC1	0	P1 output (port P1).	P1 pin output control.															
		1	R signal output.																
2	PTC2	0	P2 output (port P2).	P2 pin output control.															
		1	Can not be used.																
3	PTC3	0	P3 output (port P3).	P3 pin output control.															
		1	G signal output.																
4	PTC4	0	P4 output (port P4).	P4 pin output control.															
		1	Can not be used.																
5	PTC5	0	P5 output (port P5).	P5 pin output control.															
		1	B signal output.																
6	PTC6	0	P6 output (port P6).	P6 pin output control.															
		1	Can not be used.																
7	PTC7	0	P7 output (port P7).	P7 pin output control.															
		1	Can not be used.																
8	DIVS0	0	For setting, see REGISTER SUPPLEMENTARY DESCRIPTION (2).	Set display frequency range.															
		1																	
9	DIVS1	0																	
		1																	
A	DIVS2	0																	
		1																	
B	RSEL0	0																	
		1																	
C	RSEL1	0																	
		1																	
D	EXCK0	0	<table border="1"> <thead> <tr> <th>EXCK1</th> <th>EXCK0</th> <th>Display clock input</th> </tr> </thead> <tbody> <tr> <td>0</td> <td>0</td> <td>External synchronous (external clock)</td> </tr> <tr> <td>0</td> <td>1</td> <td>Internal synchronous</td> </tr> <tr> <td>1</td> <td>0</td> <td>Do not set</td> </tr> <tr> <td>1</td> <td>1</td> <td>External synchronous (internal clock)</td> </tr> </tbody> </table>	EXCK1	EXCK0	Display clock input	0	0	External synchronous (external clock)	0	1	Internal synchronous	1	0	Do not set	1	1	External synchronous (internal clock)	Display clock setting See REGISTER SUPPLEMENTARY DESCRIPTION (1)
		EXCK1		EXCK0	Display clock input														
0	0	External synchronous (external clock)																	
0	1	Internal synchronous																	
1	0	Do not set																	
1	1	External synchronous (internal clock)																	
1																			
E	EXCK1	0																	
		1																	

Note. The mark 0 around the status value means the reset status by the "L" level is input to  $\overline{AC}$  pin.

SCREEN CHARACTER and PATTERN DISPLAY CONTROLLERS

(3) Address 122<sub>16</sub>

DA	Register	Contents		Remarks
		Status	Function	
0	PTD0	⓪	"L" output or negative polarity output (BLNK0 output).	P0 pin data control.
		1	"H" output or positive polarity output (BLNK0 output).	
1	PTD1	⓪	"L" output or negative polarity output (R signal output).	P1 pin data control.
		1	"H" output or positive polarity output (R signal output).	
2	PTD2	⓪	"L" output.	P2 pin data control.
		1	"H" output.	
3	PTD3	⓪	"L" output or negative polarity output (G signal output).	P3 pin data control.
		1	"H" output or positive polarity output (G signal output).	
4	PTD4	⓪	"L" output.	P4 pin data control.
		1	"H" output.	
5	PTD5	⓪	"L" output or negative polarity output (B signal output).	P5 pin data control.
		1	"H" output or positive polarity output (B signal output).	
6	PTD6	⓪	"L" output.	P6 pin data control.
		1	"H" output.	
7	PTD7	⓪	"L" output.	P7 pin data control.
		1	"H" output.	
8	TEST11	⓪	Can not be used.	
		1	It should be fixed to "1".	
9	TEST12	⓪	It should be fixed to "0".	
		1	Can not be used.	
A	TEST13	⓪	It should be fixed to "0".	
		1	Can not be used.	
B	TEST14	⓪	It should be fixed to "0".	
		1	Can not be used.	
C	TEST15	⓪	It should be fixed to "0".	
		1	Can not be used.	
D	TEST16	⓪	It should be fixed to "0".	
		1	Can not be used.	
E	TEST17	⓪	It should be fixed to "0".	
		1	Can not be used.	

Note. The mark ⓪ around the status value means the reset status by the "L" level is input to  $\overline{AC}$  pin.

SCREEN CHARACTER and PATTERN DISPLAY CONTROLLERS

(4) Address 123<sub>16</sub>

DA	Register	Contents		Remarks															
		Status	Function																
0	HP0	0	<p>If HS is the horizontal display start location,</p> $HS = T \times \left( \sum_{n=0}^{10} 2^n NP_{n+m} \right)$ <p>T: Period of display frequency</p> <p>2007 settings are possible.</p> <p>m : offset value differ for the setting of the register EXCK0 and EXCK1. It shown below.</p> <table border="1" style="margin-left: auto; margin-right: auto;"> <tr> <td>EXCK1</td> <td>0</td> <td>0</td> <td>1</td> <td>1</td> </tr> <tr> <td>EXCK0</td> <td>0</td> <td>1</td> <td>0</td> <td>1</td> </tr> <tr> <td>m</td> <td>13</td> <td>13</td> <td>Do not set</td> <td>19</td> </tr> </table>	EXCK1	0	0	1	1	EXCK0	0	1	0	1	m	13	13	Do not set	19	<p>Horizontal display start location is specified using the 11 bits from HP10 to HP0. HP10 to HP0 = (000000000002) and (000001001112) setting is forbidden.</p>
		EXCK1		0	0	1	1												
EXCK0	0	1		0	1														
m	13	13		Do not set	19														
1																			
1	HP1	0																	
		1																	
2	HP2	0																	
		1																	
3	HP3	0																	
		1																	
4	HP4	0																	
		1																	
5	HP5	0																	
		1																	
6	HP6	0																	
		1																	
7	HP7	0																	
		1																	
8	HP8	0																	
		1																	
9	HP9	0																	
		1																	
A	HP10	0																	
		1																	
B	TEST0	0	It should be fixed to "0".																
		1	Can not be used.																
C	TEST1	0	It should be fixed to "0".																
		1	Can not be used.																
D	TEST2	0	It should be fixed to "0".																
		1	Can not be used.																
E	TEST3	0	It should be fixed to "0".																
		1	Can not be used.																

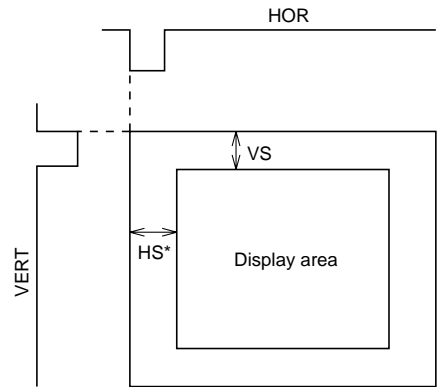

HS\*(shown left) shows horizontal display start location this is register B/F (address 129<sub>16</sub>) = "0" is set.

Note. The mark 0 around the status value means the reset status by the "L" level is input to AC pin.

SCREEN CHARACTER and PATTERN DISPLAY CONTROLLERS

(5) Address 124<sub>16</sub>

DA	Register	Contents		Remarks
		Status	Function	
0	VP0	0	If VS is the vertical display start location, $VS = H \times \sum_{n=0}^{10} 2^n VP_n$	The vertical start location is specified using the 11 bits from VP10 to VP0. VP10 to VP0 = (00000000000 <sub>2</sub> ) setting is forbidden.  HS*(shown left) shows horizontal display start location this is register B/F (address 129 <sub>16</sub> ) = "0" is set.
		1		
1	VP1	0	T: Cycle with the horizontal synchronizing pulse 2047 settings are possible.	
		1		
2	VP2	0		
		1		
3	VP3	0		
		1		
4	VP4	0		
		1		
5	VP5	0		
		1		
6	VP6	0		
		1		
7	VP7	0		
		1		
8	VP8	0		
		1		
9	VP9	0		
		1		
A	VP10	0		
		1		
B	TEST18	0	It should be fixed to "0".	
		1	Can not be used.	
C	TEST19	0	It should be fixed to "0".	
		1	Can not be used.	
D	RBLK0	0	Matrix-outline size.	Sets the blanking mode of RAM character. See DISPLAY FORM 2.
		1	Character size. (Note 2)	
E	TEST20	0	It should be fixed to "0".	
		1	Can not be used.	

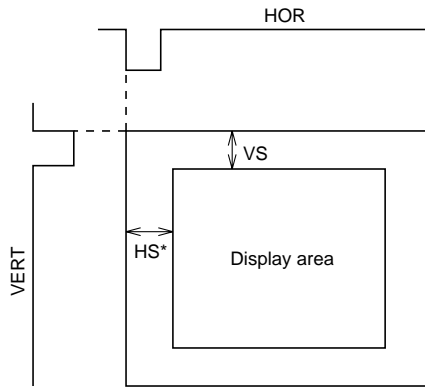

Note1. The mark 0 around the status value means the reset status by the "L" level is input to AC pin.  
 Note2. The part of the appointed color by BB, BG and BB of the display RAM changes that the blanking is "OFF".

SCREEN CHARACTER and PATTERN DISPLAY CONTROLLERS

(6) Address 125<sub>16</sub>

DA	Register	Contents		Remarks																				
		Status	Function																					
0	DSP0	0	The display modes of display screen inside n+1 line by DSPn (n=0~11)	Sets the display mode of line 1.																				
		1																						
1	DSP1	0	The display mode decided by the combination with registers BLK1 and BLK0 (address 129 <sub>16</sub> ). Settings are given below.	Sets the display mode of line 2.																				
		1																						
2	DSP2	0	<table border="1" style="margin-left: auto; margin-right: auto;"> <thead> <tr> <th>BLK1</th> <th>BLK0</th> <th>DSPn="0"</th> <th>DSPn="1"</th> </tr> </thead> <tbody> <tr> <td>0</td> <td>0</td> <td>Matrix-outline border</td> <td>Matrix-outline</td> </tr> <tr> <td>0</td> <td>1</td> <td>Character</td> <td>Border</td> </tr> <tr> <td>1</td> <td>0</td> <td>Border</td> <td>Matrix-outline</td> </tr> <tr> <td>1</td> <td>1</td> <td>Matrix-outline</td> <td>Character</td> </tr> </tbody> </table>	BLK1	BLK0	DSPn="0"	DSPn="1"	0	0	Matrix-outline border	Matrix-outline	0	1	Character	Border	1	0	Border	Matrix-outline	1	1	Matrix-outline	Character	Sets the display mode of line 3.
		BLK1		BLK0	DSPn="0"	DSPn="1"																		
0	0	Matrix-outline border	Matrix-outline																					
0	1	Character	Border																					
1	0	Border	Matrix-outline																					
1	1	Matrix-outline	Character																					
1																								
3	DSP3	0	(At register BCOL="0")	Sets the display mode of line 4.																				
		1																						
4	DSP4	0	For detail, see DISPLAY FORM 1 (1).	Sets the display mode of line 5.																				
		1																						
5	DSP5	0		Sets the display mode of line 6.																				
		1																						
6	DSP6	0		Sets the display mode of line 7.																				
		1																						
7	DSP7	0		Sets the display mode of line 8.																				
		1																						
8	DSP8	0		Sets the display mode of line 9.																				
		1																						
9	DSP9	0		Sets the display mode of line 10.																				
		1																						
A	DSP10	0		Sets the display mode of line 11.																				
		1																						
B	DSP11	0		Sets the display mode of line 12.																				
		1																						
C	TEST21	0	It should be fixed to "0".																					
		1	Can not be used.																					
D	TEST22	0	It should be fixed to "0".																					
		1	Can not be used.																					
E	TEST23	0	It should be fixed to "0".																					
		1	Can not be used.																					

Note. The mark 0 around the status value means the reset status by the "L" level is input to  $\overline{AC}$  pin.

SCREEN CHARACTER and PATTERN DISPLAY CONTROLLERS

(7) Address 126<sub>16</sub>

DA	Register	Contents		Remarks															
		Status	Function																
0	LIN2	0	The vertical dot size for line n in the character dot lines (18 vertical lines) is set using LINn (n = 2 to 17).	Character size setting in the vertical direction for the 2nd line.															
		1																	
1	LIN3	0	Dot size can be selected between 2 types for each dot line.	Character size setting in the vertical direction for the 3rd line.															
		1																	
2	LIN4	0	For dot size, see the below registers. Line 1 and lines 2 to 12 can be set independent of one another.	Character size setting in the vertical direction for the 4th line.															
		1																	
3	LIN5	0	<table border="1" style="display: inline-table; vertical-align: middle;"> <thead> <tr> <th></th> <th>LINn = "0"</th> <th>LINn = "1"</th> </tr> </thead> <tbody> <tr> <td>1st line</td> <td>Refer to VSZ1L0 and VSZ1L1</td> <td>Refer to VSZ1H0 and VSZ1H1</td> </tr> <tr> <td>2nd to 12th line</td> <td>Refer to VSZ2L0 and VSZ2L1</td> <td>Refer to VSZ2H0 and VSZ2H1</td> </tr> </tbody> </table>		LINn = "0"	LINn = "1"	1st line	Refer to VSZ1L0 and VSZ1L1	Refer to VSZ1H0 and VSZ1H1	2nd to 12th line	Refer to VSZ2L0 and VSZ2L1	Refer to VSZ2H0 and VSZ2H1	Character size setting in the vertical direction for the 5th line.						
				LINn = "0"	LINn = "1"														
1st line	Refer to VSZ1L0 and VSZ1L1	Refer to VSZ1H0 and VSZ1H1																	
2nd to 12th line	Refer to VSZ2L0 and VSZ2L1	Refer to VSZ2H0 and VSZ2H1																	
1																			
4	LIN6	0		Character size setting in the vertical direction for the 6th line.															
		1																	
5	LIN7	0		Character size setting in the vertical direction for the 7th line.															
		1																	
6	LIN8	0		Character size setting in the vertical direction for the 8th line.															
		1																	
7	LIN9	0		Character size setting in the vertical direction for the 9th line.															
		1																	
8	V1SZ0	0	H: Cycle with the horizontal synchronizing pulse	Character size setting in the vertical direction for the 1st line. (display monitor 1 to 12 line)															
		1																	
9	V1SZ1	0	<table border="1" style="display: inline-table; vertical-align: middle;"> <thead> <tr> <th>V1SZ1</th> <th>V1SZ0</th> <th>Vertical direction size</th> </tr> </thead> <tbody> <tr> <td>0</td> <td>0</td> <td>1H/dot</td> </tr> <tr> <td>0</td> <td>1</td> <td>2H/dot</td> </tr> <tr> <td>1</td> <td>0</td> <td>3H/dot</td> </tr> <tr> <td>1</td> <td>1</td> <td>4H/dot</td> </tr> </tbody> </table>	V1SZ1	V1SZ0	Vertical direction size	0	0	1H/dot	0	1	2H/dot	1	0	3H/dot	1	1	4H/dot	
		V1SZ1		V1SZ0	Vertical direction size														
0	0	1H/dot																	
0	1	2H/dot																	
1	0	3H/dot																	
1	1	4H/dot																	
1																			
A	VSZ1L0	0	H: Cycle with the horizontal synchronizing pulse	Character size setting in the vertical direction (display monitor 1 line) at "0" state in register LIN2 to LIN17 (address 126 <sub>16</sub> , 127 <sub>16</sub> ).															
		1																	
B	VSZ1L1	0	<table border="1" style="display: inline-table; vertical-align: middle;"> <thead> <tr> <th>VSZ1L1</th> <th>VSZ1L0</th> <th>Vertical direction size</th> </tr> </thead> <tbody> <tr> <td>0</td> <td>0</td> <td>1H/dot</td> </tr> <tr> <td>0</td> <td>1</td> <td>2H/dot</td> </tr> <tr> <td>1</td> <td>0</td> <td>3H/dot</td> </tr> <tr> <td>1</td> <td>1</td> <td>4H/dot</td> </tr> </tbody> </table>	VSZ1L1	VSZ1L0	Vertical direction size	0	0	1H/dot	0	1	2H/dot	1	0	3H/dot	1	1	4H/dot	
		VSZ1L1		VSZ1L0	Vertical direction size														
0	0	1H/dot																	
0	1	2H/dot																	
1	0	3H/dot																	
1	1	4H/dot																	
1																			
C	VSZ1H0	0	H: Cycle with the horizontal synchronizing pulse	Character size setting in the vertical direction (display monitor 1 line) at "1" state in register LIN2 to LIN17 (address 126 <sub>16</sub> , 127 <sub>16</sub> ).															
		1																	
D	VSZ1H1	0	<table border="1" style="display: inline-table; vertical-align: middle;"> <thead> <tr> <th>VSZ1H1</th> <th>VSZ1H0</th> <th>Vertical direction size</th> </tr> </thead> <tbody> <tr> <td>0</td> <td>0</td> <td>1H/dot</td> </tr> <tr> <td>0</td> <td>1</td> <td>2H/dot</td> </tr> <tr> <td>1</td> <td>0</td> <td>3H/dot</td> </tr> <tr> <td>1</td> <td>1</td> <td>4H/dot</td> </tr> </tbody> </table>	VSZ1H1	VSZ1H0	Vertical direction size	0	0	1H/dot	0	1	2H/dot	1	0	3H/dot	1	1	4H/dot	
		VSZ1H1		VSZ1H0	Vertical direction size														
0	0	1H/dot																	
0	1	2H/dot																	
1	0	3H/dot																	
1	1	4H/dot																	
1																			
E	TEST24	0	It should be fixed to "0".																
		1			Can not be used.														

Note. The mark ○ around the status value means the reset status by the "L" level is input to  $\overline{AC}$  pin.



SCREEN CHARACTER and PATTERN DISPLAY CONTROLLERS

(8) Address 127<sub>16</sub>

DA	Register	Contents		Remarks															
		Status	Function																
0	LIN10	0	The vertical dot size for line n in the character dot lines (18 vertical lines) is set using LINn (n = 2 to 17).	Character size setting in the vertical direction for the 10th line.															
		1																	
1	LIN11	0	Dot size can be selected between 2 types for each dot line.	Character size setting in the vertical direction for the 11th line.															
		1																	
2	LIN12	0	For dot size, see the below registers. Line 1 and lines 2 to 12 can be set independent of one another.	Character size setting in the vertical direction for the 12th line.															
		1																	
3	LIN13	0	<table border="1" style="margin-left: auto; margin-right: auto;"> <thead> <tr> <th></th> <th>LINn = "0"</th> <th>LINn = "1"</th> </tr> </thead> <tbody> <tr> <td>1st line</td> <td>Refer to VSZ1L0 and VSZ1L1</td> <td>Refer to VSZ1H0 and VSZ1H1</td> </tr> <tr> <td>2nd to 12th line</td> <td>Refer to VSZ2L0 and VSZ2L1</td> <td>Refer to VSZ2H0 and VSZ2H1</td> </tr> </tbody> </table>		LINn = "0"	LINn = "1"	1st line	Refer to VSZ1L0 and VSZ1L1	Refer to VSZ1H0 and VSZ1H1	2nd to 12th line	Refer to VSZ2L0 and VSZ2L1	Refer to VSZ2H0 and VSZ2H1	Character size setting in the vertical direction for the 13th line.						
				LINn = "0"	LINn = "1"														
1st line	Refer to VSZ1L0 and VSZ1L1	Refer to VSZ1H0 and VSZ1H1																	
2nd to 12th line	Refer to VSZ2L0 and VSZ2L1	Refer to VSZ2H0 and VSZ2H1																	
1																			
4	LIN14	0		Character size setting in the vertical direction for the 14th line.															
		1																	
5	LIN15	0		Character size setting in the vertical direction for the 15th line.															
		1																	
6	LIN16	0		Character size setting in the vertical direction for the 16th line.															
		1																	
7	LIN17	0		Character size setting in the vertical direction for the 17th line.															
		1																	
8	V18SZ0	0	H: Cycle with the horizontal synchronizing pulse	Character size setting in the vertical direction for the 18th line. (display monitor 1 to 12 line)															
		1																	
9	V18SZ1	0	<table border="1" style="margin-left: auto; margin-right: auto;"> <thead> <tr> <th>V18SZ1</th> <th>V18SZ0</th> <th>Vertical direction size</th> </tr> </thead> <tbody> <tr> <td>0</td> <td>0</td> <td>1H/dot</td> </tr> <tr> <td>0</td> <td>1</td> <td>2H/dot</td> </tr> <tr> <td>1</td> <td>0</td> <td>3H/dot</td> </tr> <tr> <td>1</td> <td>1</td> <td>4H/dot</td> </tr> </tbody> </table>	V18SZ1	V18SZ0	Vertical direction size	0	0	1H/dot	0	1	2H/dot	1	0	3H/dot	1	1	4H/dot	
		V18SZ1		V18SZ0	Vertical direction size														
0	0	1H/dot																	
0	1	2H/dot																	
1	0	3H/dot																	
1	1	4H/dot																	
1																			
A	VSZ2L0	0	H: Cycle with the horizontal synchronizing pulse	Character size setting in the vertical direction (display monitor for 2 to 12 line) at "0" state in register LIN2 to LIN17 (address 126 <sub>16</sub> , 127 <sub>16</sub> ).															
		1																	
B	VSZ2L1	0	<table border="1" style="margin-left: auto; margin-right: auto;"> <thead> <tr> <th>VSZ2L1</th> <th>VSZ2L0</th> <th>Vertical direction size</th> </tr> </thead> <tbody> <tr> <td>0</td> <td>0</td> <td>1H/dot</td> </tr> <tr> <td>0</td> <td>1</td> <td>2H/dot</td> </tr> <tr> <td>1</td> <td>0</td> <td>3H/dot</td> </tr> <tr> <td>1</td> <td>1</td> <td>4H/dot</td> </tr> </tbody> </table>	VSZ2L1	VSZ2L0	Vertical direction size	0	0	1H/dot	0	1	2H/dot	1	0	3H/dot	1	1	4H/dot	
		VSZ2L1		VSZ2L0	Vertical direction size														
0	0	1H/dot																	
0	1	2H/dot																	
1	0	3H/dot																	
1	1	4H/dot																	
1																			
C	VSZ2H0	0	H: Cycle with the horizontal synchronizing pulse	Character size setting in the vertical direction (display monitor for 2 to 12 line) at "1" state in register LIN2 to LIN17 (address 126 <sub>16</sub> , 127 <sub>16</sub> ).															
		1																	
D	VSZ2H1	0	<table border="1" style="margin-left: auto; margin-right: auto;"> <thead> <tr> <th>VSZ2H1</th> <th>VSZ2H0</th> <th>Vertical direction size</th> </tr> </thead> <tbody> <tr> <td>0</td> <td>0</td> <td>1H/dot</td> </tr> <tr> <td>1</td> <td>1</td> <td>2H/dot</td> </tr> <tr> <td>0</td> <td>0</td> <td>3H/dot</td> </tr> <tr> <td>1</td> <td>1</td> <td>4H/dot</td> </tr> </tbody> </table>	VSZ2H1	VSZ2H0	Vertical direction size	0	0	1H/dot	1	1	2H/dot	0	0	3H/dot	1	1	4H/dot	
		VSZ2H1		VSZ2H0	Vertical direction size														
0	0	1H/dot																	
1	1	2H/dot																	
0	0	3H/dot																	
1	1	4H/dot																	
1																			
E	TEST25	0	It should be fixed to "0".																
		1	Can not be used.																

Note. The mark ○ around the status value means the reset status by the "L" level is input to  $\overline{AC}$  pin.

SCREEN CHARACTER and PATTERN DISPLAY CONTROLLERS

(9) Address 128<sub>16</sub>

DA	Register	Contents				Remarks	
		Status	Function				
0	RR	⓪				Sets the raster color of all blankings.	
		1	RB	RG	RR		Color
1	RG	⓪	0	0	0		Black
		1	0	0	1		Red
2	RB	⓪	0	1	0		Green
		1	0	1	1		Yellow
3	FR	⓪	1	0	0		Blue
		1	1	0	1		Magenta
4	FG	⓪	1	1	0		Cyan
		1	1	1	1		White
5	FB	⓪				Set the blanking color of the Border size, or the shadow size.	
		1	FB	FG	FR		Color
6	TEST26	⓪	0	0	0		Black
		1	0	0	1		Red
7	TEST27	⓪	0	1	0		Green
		1	0	1	1		Yellow
8	TEST28	⓪	1	0	0		Blue
		1	1	0	1		Magenta
9	BETA14	⓪	1	1	0		Cyan
		1	1	1	1		White
A	HSZ10	⓪	It should be fixed to "0".			Charcter size setting in the horizontal direction for the first line. T: Display frequency cycle	
		1	Can not be used.				
B	HSZ11	⓪	HSZ11	HSZ10	Horizontal direction size		
		1	0	0	1T/dot		
C	HSZ20	⓪	0	1	2T/dot		
		1	1	0	3T/dot		
D	HSZ21	⓪	1	1	4T/dot		
		1	Can not be used.				
E	TEST29	⓪	It should be fixed to "0".				
		1	Can not be used.				

Note. The mark ⓪ around the status value means the reset status by the "L" level is input to  $\overline{AC}$  pin.

SCREEN CHARACTER and PATTERN DISPLAY CONTROLLERS

(10) Address 129<sub>16</sub>

DA	Register	Contents		Remarks															
		Status	Function																
0	BCOL	0	Blanking of BLK0, BLK1	Sets all raster blanking															
		1	All raster blanking																
1	B $\bar{F}$	0	Synchronize with the leading edge of horizontal synchronization.	Synchronize with the front porch or back porch of the horizontal synchronization signal.															
		1	Synchronize with the trailing edge of horizontal synchronization.																
2	VMASK	0	Do not mask by VERT input signal	Set mask at phase comparison operating.															
		1	Mask by VERT input signal																
3	POLV	0	VERT pin is negative polarity	Set VERT pin polarity.															
		1	VERT pin is positive polarity																
4	POLH	0	HOR pin is negative polarity	Set HOR pin polarity.															
		1	HOR pin is positive polarity																
5	BLK0	0	<table border="1"> <thead> <tr> <th>BLK1</th> <th>BLK0</th> <th>Blanking mode</th> </tr> </thead> <tbody> <tr> <td>0</td> <td>0</td> <td>Matrix-outline size</td> </tr> <tr> <td>0</td> <td>1</td> <td>Character size</td> </tr> <tr> <td>1</td> <td>0</td> <td>Border size</td> </tr> <tr> <td>1</td> <td>1</td> <td>Matrix-outline size</td> </tr> </tbody> </table>	BLK1	BLK0	Blanking mode	0	0	Matrix-outline size	0	1	Character size	1	0	Border size	1	1	Matrix-outline size	Set blanking mode. See DISPLAY FORM 1 (1).
BLK1	BLK0	Blanking mode																	
0	0	Matrix-outline size																	
0	1	Character size																	
1	0	Border size																	
1	1	Matrix-outline size																	
1	( When DSPn (address 125 <sub>16</sub> ) = "0" )																		
6	BLK1	0	( When DSPn (address 125 <sub>16</sub> ) = "0" )																
		1																	
7	SYAD	0	Border display of character	See DISPLAY FORM 1 (2).															
		1	Shadow display of character																
8	RAMERS	0	RAM not erased	When register RAMERS is set to "1," do not stop the display clock. There is no need to reset because there is no register for this bit. Refer to REGISTER SUPPLEMENTARY DESCRIPTION.															
		1	RAM erased																
9	STOP	0	Oscillation of clock for display																
		1	Stop the oscillation of clock for display																
A	DSPON	0	Display OFF																
		1	Display ON																
B	BLINK0	0	<table border="1"> <thead> <tr> <th>BLINK1</th> <th>BLINK0</th> <th>Duty</th> </tr> </thead> <tbody> <tr> <td>0</td> <td>0</td> <td>Blinking OFF</td> </tr> <tr> <td>0</td> <td>1</td> <td>25%</td> </tr> <tr> <td>1</td> <td>0</td> <td>50%</td> </tr> <tr> <td>1</td> <td>1</td> <td>75%</td> </tr> </tbody> </table>	BLINK1	BLINK0	Duty	0	0	Blinking OFF	0	1	25%	1	0	50%	1	1	75%	Set blinking duty ratio.
BLINK1	BLINK0	Duty																	
0	0	Blinking OFF																	
0	1	25%																	
1	0	50%																	
1	1	75%																	
1																			
C	BLINK1	0																	
		1																	
D	BLINK2	0	Divided into 64 of vertical synchronous signal	Set blinking frequency.															
		1	Divided into 32 of vertical synchronous signal																
E	TEST30	0	It should be fixed to "0".																
		1	Can not be used.																

Note. The mark 0 around the status value means the reset status by the "L" level is input to  $\bar{AC}$  pin.

**REGISTER SUPPLEMENTARY DESCRIPTION**

(1) Setting external clock input and display frequency mode  
 Setting external clock input and display frequency mode (by use of EXCK0, EXCK1 (121<sub>16</sub>) and DIV10 to DIV0 (120<sub>16</sub>), as explained here following.

(a) When (EXCK1, EXCK0) = (0, 0) .....External synchronous 1 (External clock display) ... Fosc = 20 to 70 MHz  
 Input from the TCK pin a constant-period continuous external clock that synchronizes with the horizontal synchronous signal. And input from HOR pin a constant period continuous horizontal synchronous signal. Never stop inputting the clock while displaying. Do not have to set a display frequency because the clock just as it is entered from outside is used as the display clock.

(b) When (EXCK1, EXCK0) = (0, 1) .....Internal synchronous... Fosc = 20 to 100 MHz  
 Clock input from the TCK pin is unnecessary. The multiply clock of the internally generated horizontal synchronous signal is used as the display clock. The display frequency is set by setting the multiply value of the horizontal synchronous frequency (of the display frequency) in DIV10 to DIV0 (address 120<sub>16</sub>). Also, set the display frequency range. (See the next page.) Display frequency is calculated using the below expression.

$$\text{Display frequency} = \text{Horizontal synchronous frequency} \times \text{Multiply value}$$

(c) When (EXCK1, EXCK0) = (1, 0) ..... Setting disabled

(d) When (EXCK1, EXCK0) = (1, 1) .....External synchronous 2 (Internal oscillation clock display) ... Fosc = 20 to 100 MHz  
 Input from the TCK pin a constant-period continuous external clock that synchronizes with the horizontal synchronous signal. And input from HOR pin a constant-period continuous horizontal synchronous signal. Never stop inputting the clock while displaying. An internal clock which is in sync with the external input clock is used as the display clock.

Because the display frequency equals the external clock frequency, set N1 (division value) that satisfies the below expressions to DIV10 to DIV0 (address 120<sub>16</sub>) for make the display frequency is equal to the external clock frequency.

$$N1 = \text{external clock frequency} / \text{horizontal synchronous frequency}$$

$$N1 = \sum_{n=0}^{10} 2^n \text{DIV}_n$$

Also, set the display frequency range. (See the next page.)

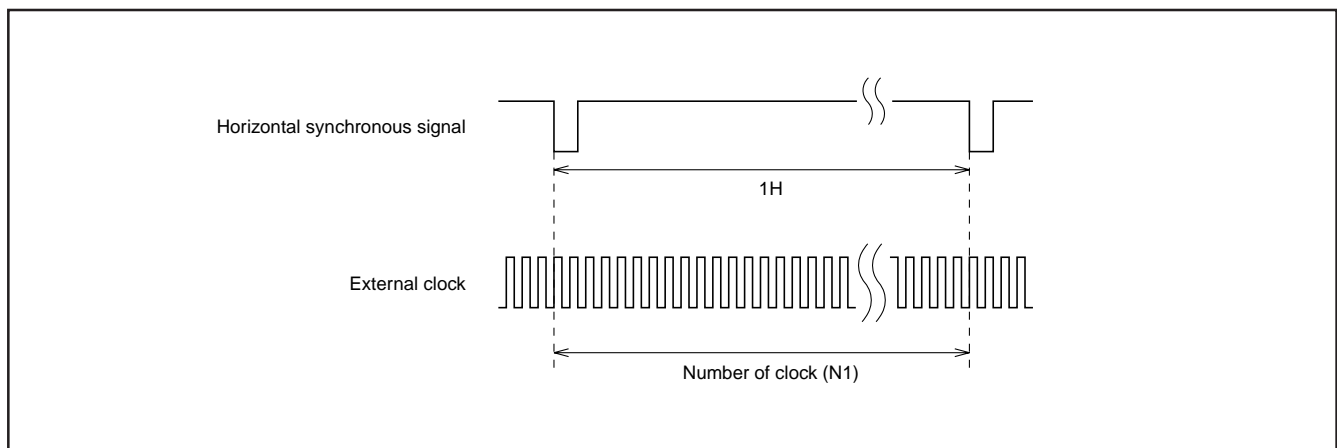

Fig. 12 Example of external clock input

(2) To set display frequency range

Whenever setting display frequency (when EXCK1 = "0", EXCK0 = "1", or EXCK1 = "1", EXCK0 = "1"), always set the display frequency range in accordance with the display frequency. This range is set from DIVS0, DIVS1, DIVS2, RSEL0 and RSEL1 (address 121<sub>16</sub>). Frequency ranges are given here below.

RSEL1	RSEL0	DIVS2	DIVS1	DIVS0	Display frequency range MHz
0	1	0	0	0	90.00 to 100.00
0	0	0	0	0	80.00 to 90.50
1	1	0	0	1	73.33 to 80.67
1	0	0	0	1	66.67 to 74.00
0	1	0	0	1	60.00 to 67.33
0	0	0	0	1	53.33 to 60.67
1	0	0	1	0	50.00 to 54.00
0	1	0	1	0	45.00 to 50.50
0	0	0	1	0	40.00 to 45.50
1	1	0	1	1	36.67 to 40.33
1	0	0	1	1	33.33 to 37.00
0	1	0	1	1	30.00 to 33.67
0	0	0	1	1	26.67 to 30.33
1	0	1	0	0	25.00 to 27.75
0	1	1	0	0	22.50 to 25.25
0	0	1	0	0	20.00 to 22.75

(3) Notes on setting display frequency

To change external clock (display) frequency or horizontal synchronization frequency, always use the following procedures.

To set EXCK1 = "0", EXCK0 = "1"

- (a) Turn the display OFF. ... DSPON (address 129<sub>16</sub>) = "0"
- (b) Set the display frequency. ... Set from DIV10 to DIV0(address 120<sub>16</sub>), DIVS0, DIVS1, DIVS2, RSEL0 and RSEL1 (address 121<sub>16</sub>).
- (c) Wait 20 ms while the horizontal synchronization signal is being input.
- (d) Turn the display ON. ... DSPON (address 129<sub>16</sub>) = "1"

To set EXCK1 = "1", EXCK0 = "1"

- (a) Turn the display OFF. ... DSPON (address 129<sub>16</sub>) = "0"
- (b) Set the display frequency. ... Set from DIV10 to DIV0(address 120<sub>16</sub>), DIVS0, DIVS1, DIVS2, RSEL0 and RSEL1 (address 121<sub>16</sub>).
- (c) Wait 20 ms while the horizontal synchronization signal and external clock are being input.
- (d) Turn the display ON. ... DSPON (address 129<sub>16</sub>) = "1"

SCREEN CHARACTER and PATTERN DISPLAY CONTROLLERS

**DISPLAY FORM 1**

M35047-XXXSP/FP has the following four display forms.

(1) ROM character blanking mode

Character size

: Blanking same as the character size.

Border size

: Blanking the background as a size from character.

Matrix-outline size

: Blanking the background 12 X 18 dot.

All blanking size

: When set register BCOL to "1", all raster area is blanking.

The display mode and blanking mode can be set line-by-line, as follows, from registers BCOL, BLK1, BLK0 (address 129<sub>16</sub>), DSP0 to DSP11 (address 125<sub>16</sub>).

BCOL	BLK1	BLK0	Line of DSPn = "0"		Line of DSPn = "1"	
			Display mode	Blanking mode	Display mode	Blanking mode
0	0	0	Matrix-outline border display	Matrix-outline size	Matrix-outline display	Matrix-outline size
	0	1	Character display	Character size	Border display	Border size
	1	0	Border display	Border size	Matrix-outline display	Matrix-outlinesize
	1	1	Matrix-outline display	Matrix-outline size	Character display	Character size
1	0	0	Matrix-outline border display	All blanking size	Matrix-outline display	All blanking size
	0	1	Character display		Border display	
	1	0	Border display		Matrix-outline display	
	1	1	Matrix-outline display		Character display	

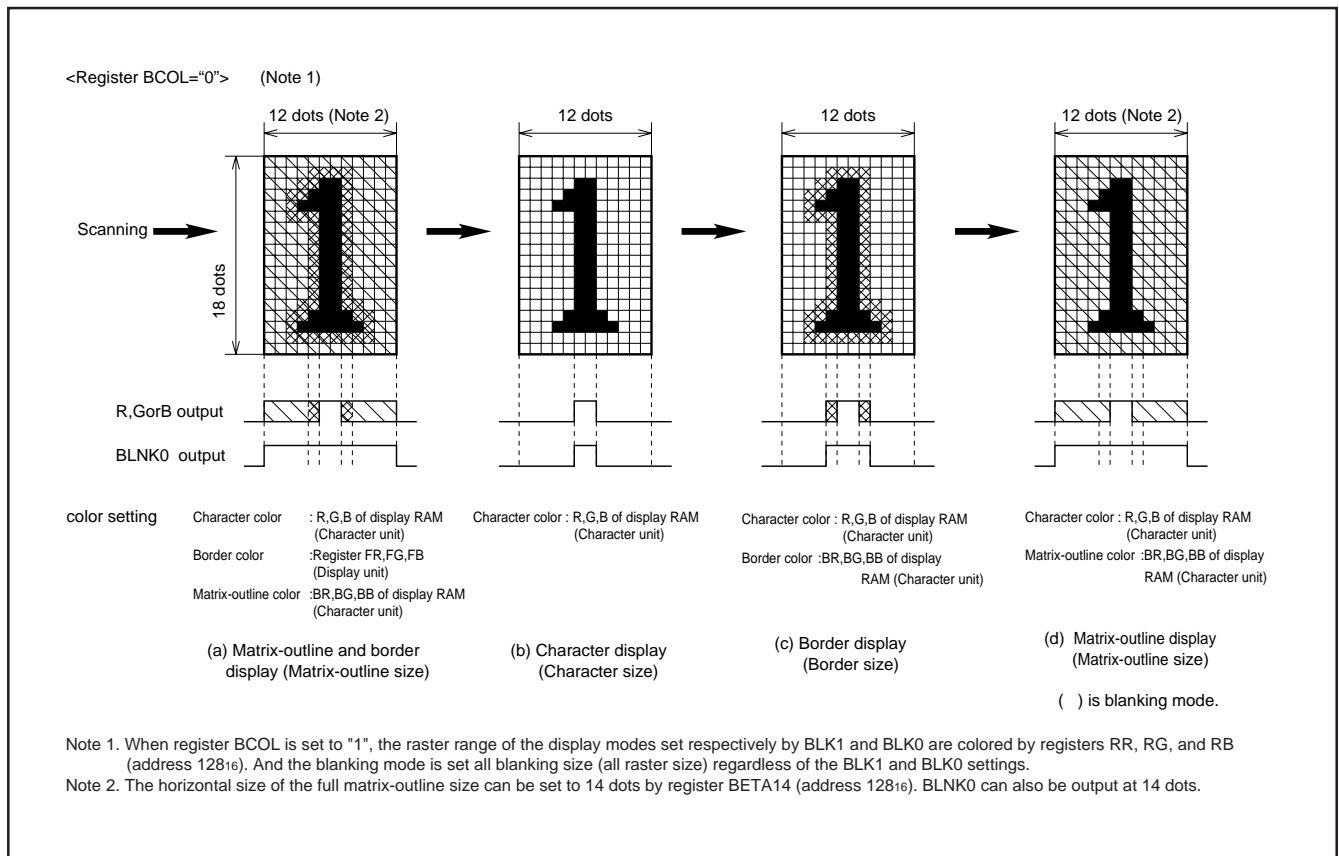

Fig. 13 Display form

SCREEN CHARACTER and PATTERN DISPLAY CONTROLLERS

(2) Shadow display

When border display mode, if set SYAD (address 129<sub>16</sub>) = "0" to "1", it change to shadow display mode.

Border and shadow display are shown below.

Set shadow display color by BR, BG and BB of display RAM or by register FR, FG and FB.

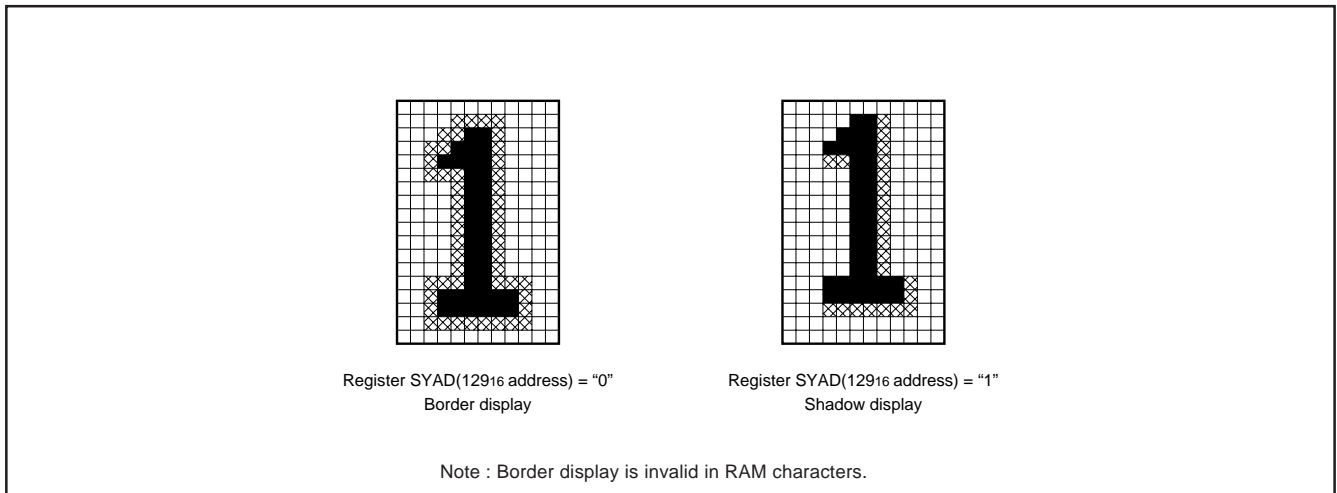

**Fig.14 Border and shadow display**

**DISPLAY FORM 2**

This IC can display both ROM character and RAM character at the same time. The display form is shown in Figure 15 and 16.

(1) RAM character blanking mode

BCOL	RBLK0	Display mode	Blanking mode
0	0	Matrix-outline display	Matrix-outline size
	1	Character display (Note1)	Character size (Note2)
1	0	Matrix-outline display	All blanking size
	1	Character display (Note1)	All blanking size

Note1: The part of the appointed color by BR, BG and BB of the display RAM changes that is not coloring.

Note2: The part of the appointed color by BR, BG and BB of the display RAM changes that the blanking is "OFF"

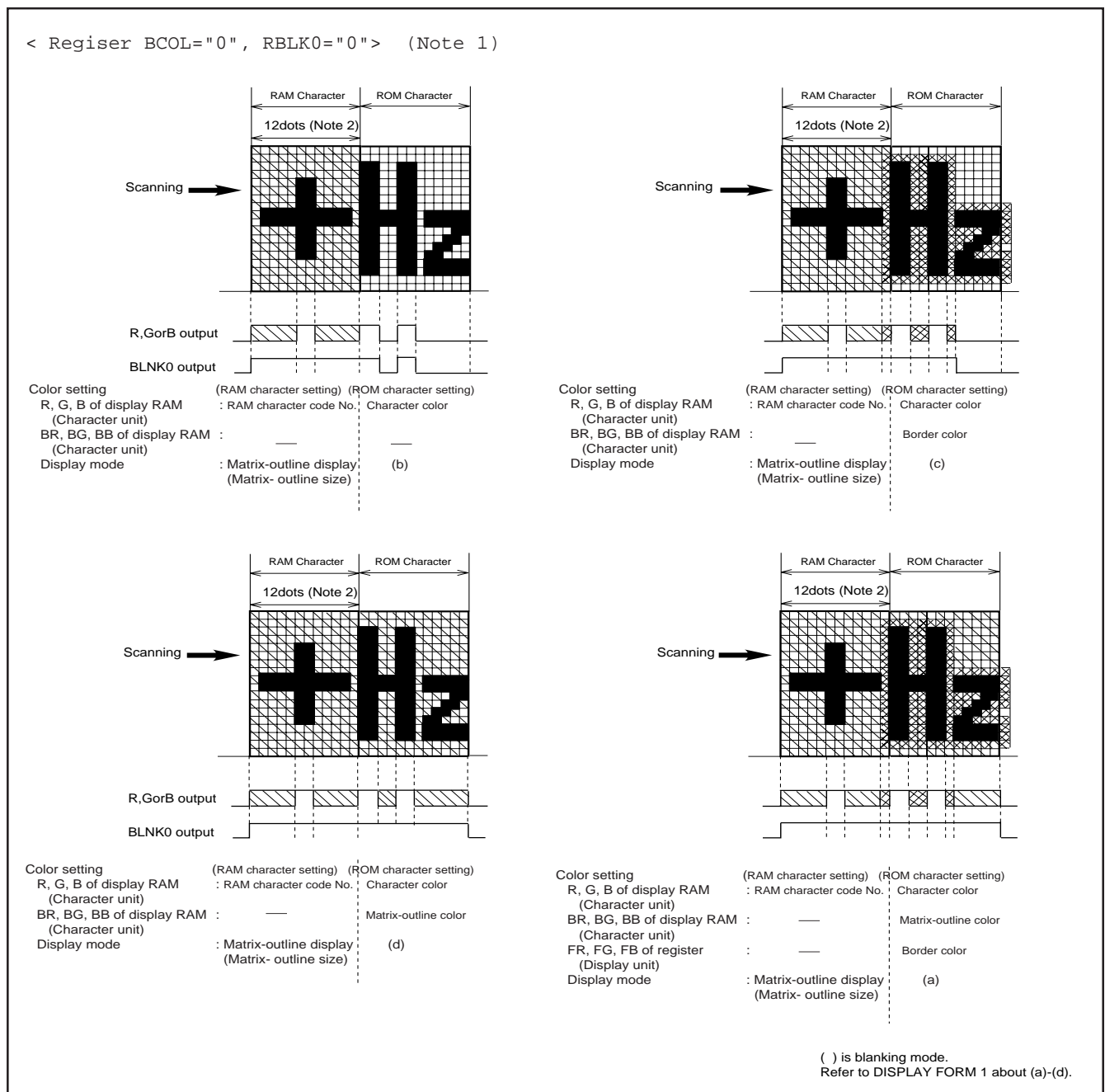

Fig.15 Display form1

Continue to Next



SCREEN CHARACTER and PATTERN DISPLAY CONTROLLERS

< Register BCOL="0", RBLK0="1" > (Note 1)

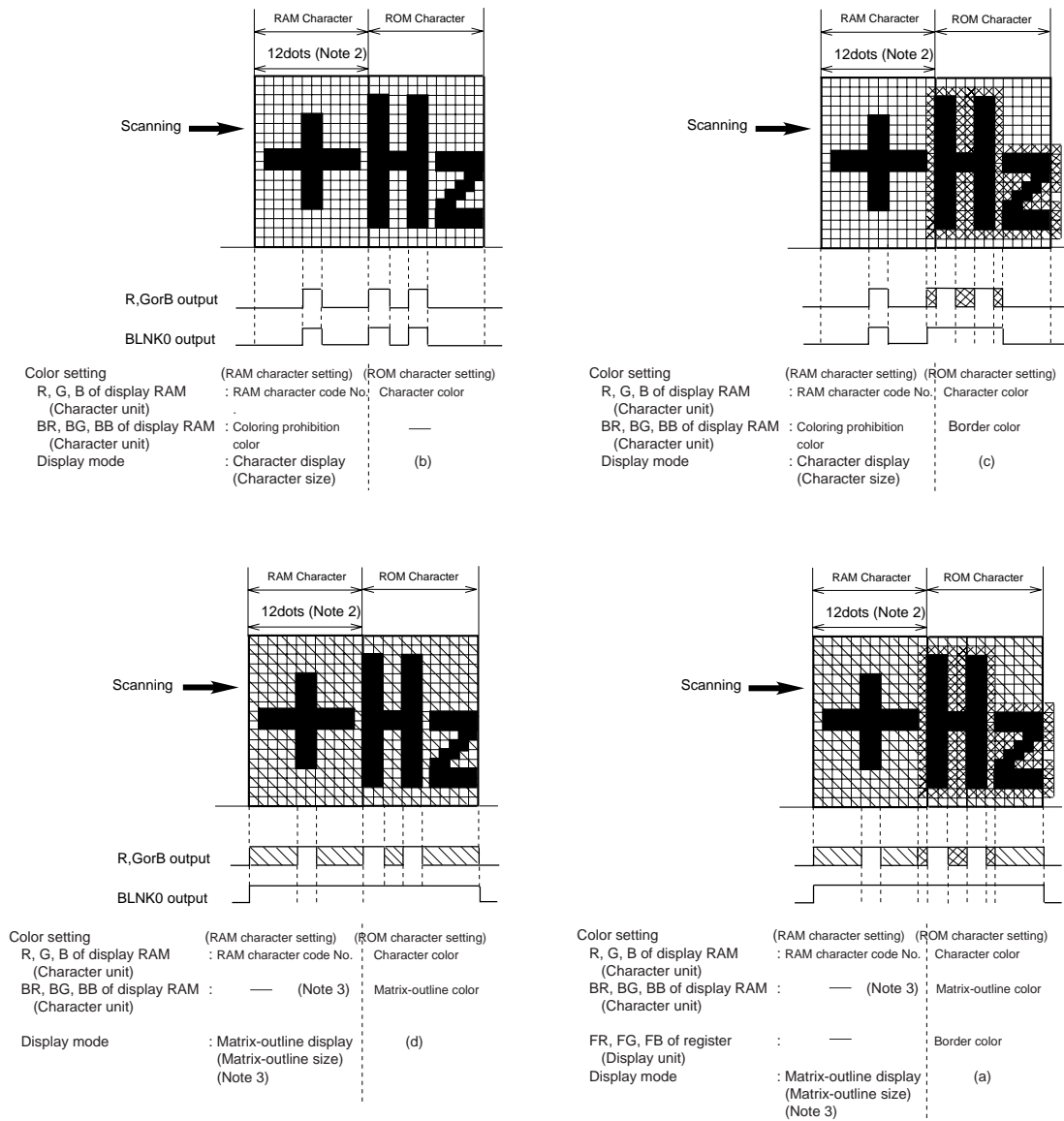

( ) is blanking mode.  
Refer to DISPLAY FORM 1 about (a)-(d).

- Note 1 : When register BCOL = "1", the raster range of the display modes set respectively by RBLK0 is colored by register RR, RG and RB (address 128<sub>16</sub>) . And the blanking mode is set all blanking size (all raster size) independent of the RBLK0 settings.
- Note 2 : The horizontal size of the full matrix-outline size can be set to 14 dots by register BETA14 (address 128<sub>16</sub>). BLNK0 can also be output at 14 dots.
- Note 3 : When display mode (setting by register BLK1, BLK0, DSPn) is Matrix-outline display or Matrix-outline border display, register RBLK0= "1" setting (coloring prohibition color setting) is invalid.

Fig. 16 Display form2

Example of setting RAM character data

For example : RAM character 0

Example of setting the RED bit code data

Address	DAF	DAE (BS)	DAD (GS)	DAC (RS)	DAB (1)	DAA (2)	DA9 (3)	DA8 (4)	DA7 (5)	DA6 (6)	DA5 (7)	DA4 (8)	DA3 (9)	DA2 (10)	DA1 (11)	DA0 (12)
(1)20016	0	0	0	1	0	0	0	0	0	0	0	0	0	0	0	0
(2)20116	0	0	0	1	0	0	0	0	0	0	0	0	0	0	0	0
(3)20216	0	0	0	1	0	0	0	0	0	0	0	0	0	0	0	0
(4)20316	0	0	0	1	0	0	1	1	1	1	1	1	1	1	0	0
(5)20416	0	0	0	1	0	0	1	1	1	1	1	1	1	1	0	0
(6)20516	0	0	0	1	0	0	1	1	1	1	1	1	1	1	0	0
(7)20616	0	0	0	1	0	0	1	1	1	1	1	1	1	1	0	0
(8)20716	0	0	0	1	0	0	1	1	1	1	1	1	1	1	0	0
(9)20816	0	0	0	1	0	0	1	1	1	1	1	1	1	1	0	0
(10)20916	0	0	0	1	0	0	1	1	1	1	1	1	1	1	0	0
(11)20A16	0	0	0	1	0	0	1	1	1	1	1	1	1	1	0	0
(12)20B16	0	0	0	1	0	0	1	1	1	1	1	1	1	1	0	0
(13)20C16	0	0	0	1	0	0	1	1	1	1	1	1	1	1	0	0
(14)20D16	0	0	0	1	0	0	1	1	1	1	1	1	1	1	0	0
(15)20E16	0	0	0	1	0	0	1	1	1	1	1	1	1	1	0	0
(16)20F16	0	0	0	1	0	0	0	0	0	0	0	0	0	0	0	0
(17)21016	0	0	0	1	0	0	0	0	0	0	0	0	0	0	0	0
(18)21116	0	0	0	1	0	0	0	0	0	0	0	0	0	0	0	0
21216	Can not used															
...																
21F16	Can not used															

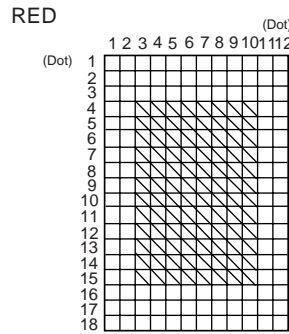

Example of setting the GREEN bit code data

Address	DAF	DAE (BS)	DAD (GS)	DAC (RS)	DAB (1)	DAA (2)	DA9 (3)	DA8 (4)	DA7 (5)	DA6 (6)	DA5 (7)	DA4 (8)	DA3 (9)	DA2 (10)	DA1 (11)	DA0 (12)
(1)20016	0	0	1	0	0	0	0	0	0	0	0	0	0	0	0	0
(2)20116	0	0	1	0	0	0	0	0	0	0	0	0	0	0	0	0
(3)20216	0	0	1	0	0	1	1	1	1	1	1	1	1	1	0	0
(4)20316	0	0	1	0	0	1	0	0	0	0	0	0	0	0	1	0
(5)20416	0	0	1	0	0	1	0	0	1	1	1	1	1	1	0	0
(6)20516	0	0	1	0	0	1	0	1	0	0	0	0	1	0	1	0
(7)20616	0	0	1	0	0	1	0	1	0	0	0	0	1	0	1	0
(8)20716	0	0	1	0	0	1	0	1	0	0	0	0	0	0	1	0
(9)20816	0	0	1	0	0	1	0	1	0	0	1	1	1	1	0	0
(10)20916	0	0	1	0	0	1	0	1	0	0	0	0	1	0	1	0
(11)20A16	0	0	1	0	0	1	0	1	0	0	0	0	1	0	1	0
(12)20B16	0	0	1	0	0	1	0	1	0	0	0	1	1	0	1	0
(13)20C16	0	0	1	0	0	1	0	0	1	1	1	1	1	0	1	0
(14)20D16	0	0	1	0	0	1	0	0	0	0	0	0	0	0	1	0
(15)20E16	0	0	1	0	0	1	0	0	0	0	0	0	0	0	1	0
(16)20F16	0	0	1	0	0	1	1	1	1	1	1	1	1	1	1	0
(17)21016	0	0	1	0	0	0	0	0	0	0	0	0	0	0	0	0
(18)21116	0	0	1	0	0	0	0	0	0	0	0	0	0	0	0	0
21216	Can not used															
...																
21F16	Can not used															

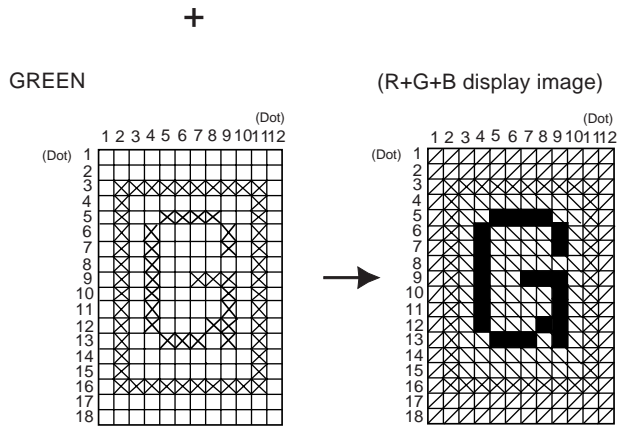

Example of setting the BLUE bit code data

Address	DAF	DAE (BS)	DAD (GS)	DAC (RS)	DAB (1)	DAA (2)	DA9 (3)	DA8 (4)	DA7 (5)	DA6 (6)	DA5 (7)	DA4 (8)	DA3 (9)	DA2 (10)	DA1 (11)	DA0 (12)
(1)20016	0	1	0	0	1	1	1	1	1	1	1	1	1	1	1	1
(2)20116	0	1	0	0	1	1	1	1	1	1	1	1	1	1	1	1
(3)20216	0	1	0	0	1	0	0	0	0	0	0	0	0	0	0	1
(4)20316	0	1	0	0	1	0	0	0	0	0	0	0	0	0	0	1
(5)20416	0	1	0	0	1	0	0	0	0	0	0	0	0	0	0	1
(6)20516	0	1	0	0	1	0	0	0	0	0	0	0	0	0	0	1
(7)20616	0	1	0	0	1	0	0	0	0	0	0	0	0	0	0	1
(8)20716	0	1	0	0	1	0	0	0	0	0	0	0	0	0	0	1
(9)20816	0	1	0	0	1	0	0	0	0	0	0	0	0	0	0	1
(10)20916	0	1	0	0	1	0	0	0	0	0	0	0	0	0	0	1
(11)20A16	0	1	0	0	1	0	0	0	0	0	0	0	0	0	0	1
(12)20B16	0	1	0	0	1	0	0	0	0	0	0	0	0	0	0	1
(13)20C16	0	1	0	0	1	0	0	0	0	0	0	0	0	0	0	1
(14)20D16	0	1	0	0	1	0	0	0	0	0	0	0	0	0	0	1
(15)20E16	0	1	0	0	1	0	0	0	0	0	0	0	0	0	0	1
(16)20F16	0	1	0	0	1	0	0	0	0	0	0	0	0	0	0	1
(17)21016	0	1	0	0	1	1	1	1	1	1	1	1	1	1	1	1
(18)21116	0	1	0	0	1	1	1	1	1	1	1	1	1	1	1	1
21216	Can not used															
...																
21F16	Can not used															

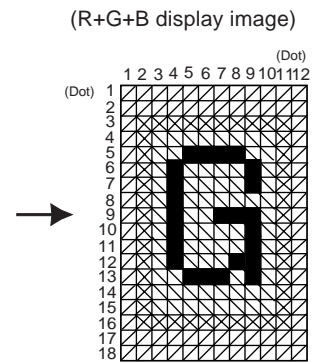
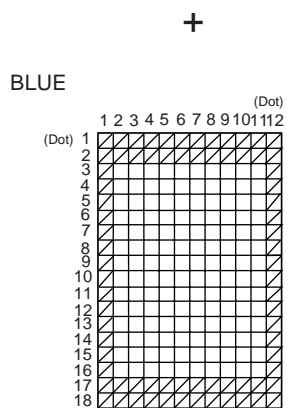

- Note 1 : After clearing or setting all character RAM areas, and use the RAM characters.
- Note 2 : The RAM character's dots are set RED, GREEN and BLUE data, which are controlled by BS, GS and RS bit. (Can be set at same time)

Fig.17 Setting of the data of RAM character

**CHARACTER FONT**

Images are composed on a 12 X 18 dot matrix, and characters can be linked vertically and horizontally with other characters to allow the display the continuous symbols.

Character code FF16 is fixed as a blank without background. Therefore, cannot register a character font in this code.

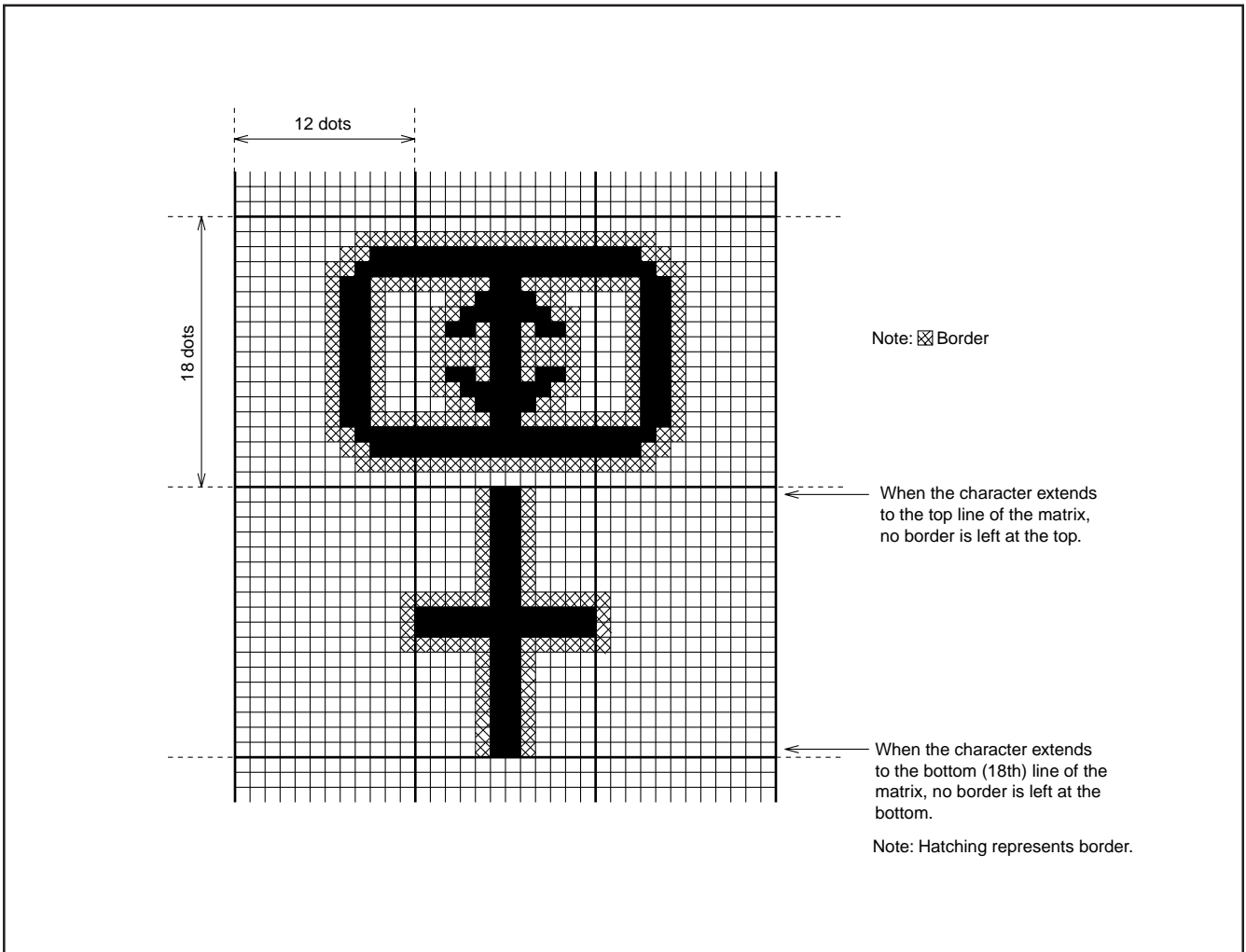

Fig.18 Example of border display

**DATA INPUT EXAMPLE**

Data of display RAM and display control registers can be set by the I<sup>2</sup>C-BUS serial input function. Example of data setting is shown in Figure 19 (at EXCK0 = "1", EXCK1 = "0" setting).

Address/data	DAF	DAE	DAD	DAC	DAB	DAA	DA9	DA8	DA7	DA6	DA5	DA4	DA3	DA2	DA1	DA0	Remarks
200 m sec hold																	System set up (Note 3)
Address 120 <sub>16</sub>	0	0	0	0	0	0	0	1	0	0	1	0	0	0	0	0	Address setting
Data 120 <sub>16</sub>	0	0	0	0	0	DIV10	DIV9	DIV8	DIV7	DIV6	DIV5	DIV4	DIV3	DIV2	DIV1	DIV0	Frequency value setting
Data 121 <sub>16</sub>	0	0	1	RSEL1	RSELO	DIVS2	DIVS1	DIVS0	1	1	1	0	1	0	1	1	Frequency range setting
Data 122 <sub>16</sub>	0	0	0	0	0	0	0	1	1	1	1	0	1	0	1	1	Output setting
Data 123 <sub>16</sub>	0	0	0	0	0	HP10	HP9	HP8	HP7	HP6	HP5	HP4	HP3	HP2	HP1	HP0	Horizontal display location setting
Data 124 <sub>16</sub>	0	0	0	0	0	VP10	VP9	VP8	VP7	VP6	VP5	VP4	VP3	VP2	VP1	VP0	Vertical display location setting
Data 125 <sub>16</sub>	0	0	0	0	0	0	0	0	0	0	0	0	0	0	0	0	Display form setting
Data 126 <sub>16</sub>	0	0	0	0	0	0	0	0	0	0	0	0	0	0	0	0	Character size setting
Data 127 <sub>16</sub>	0	0	0	0	0	0	0	0	0	0	0	0	0	0	0	0	Character size setting
Data 128 <sub>16</sub>	0	0	0	0	0	0	0	0	0	0	0	0	0	0	0	0	Color, character size setting
Data 129 <sub>16</sub>	0	0	0	0	0	0	0	0	0	0	0	POLH	POLV	0	0	0	Display OFF
20 m sec hold																	Be stable/Waiting time
Address 200 <sub>16</sub>	0	0	0	0	0	0	1	0	0	0	0	0	0	0	0	0	Address setting
Data 200 <sub>16</sub>	0	0	0	1	FR000B	FR000A	FR0009	FR0008	FR0007	FR0006	FR0005	FR0004	FR0003	FR0002	FR0001	FR0000	RED•bit code setting
⋮	⋮	Bit color			Bit code/RED												
Data 2F <sub>16</sub>	0	0	0	1	FR711B	FR711A	FR7119	FR7118	FR7117	FR7116	FR7115	FR7114	FR7113	FR7112	FR7111	FR7110	Address setting
Address 200 <sub>16</sub>	0	0	0	0	0	0	1	0	0	0	0	0	0	0	0	0	
Data 200 <sub>16</sub>	0	0	1	0	FR000B	FR000A	FR0009	FR0008	FR0007	FR0006	FR0005	FR0004	FR0003	FR0002	FR0001	FR0000	GREEN•bit code setting
⋮	⋮	Bit color			Bit code/GREEN												
Data 2F <sub>16</sub>	0	0	1	0	FR711B	FR711A	FR7119	FR7118	FR7117	FR7116	FR7115	FR7114	FR7113	FR7112	FR7111	FR7110	Address setting
Address 200 <sub>16</sub>	0	0	0	0	0	0	1	0	0	0	0	0	0	0	0	0	
Data 200 <sub>16</sub>	0	1	0	0	FR000B	FR000A	FR0009	FR0008	FR0007	FR0006	FR0005	FR0004	FR0003	FR0002	FR0001	FR0000	BLUE•bit code setting
⋮	⋮	Bit color			Bit code/BLUE												
Data 2F <sub>16</sub>	0	1	0	0	FR711B	FR711A	FR7119	FR7118	FR7117	FR7116	FR7115	FR7114	FR7113	FR7112	FR7111	FR7110	Address setting
Address 000 <sub>16</sub>	0	0	0	0	0	0	0	0	0	0	0	0	0	0	0	0	
Data 000 <sub>16</sub>	0	BB	BG	BR	BLINK	B	G	R	C7	C6	C5	C4	C3	C2	C1	C0	Character setting
⋮	⋮	Background coloring			Blink-ing	Character color			Character code								
Data 11F <sub>16</sub>	0	BB	BG	BR	BLINK	B	G	R	C7	C6	C5	C4	C3	C2	C1	C0	
Address 129 <sub>16</sub>	0	0	0	0	0	0	0	1	0	0	1	0	1	0	0	1	Address setting
Data 129 <sub>16</sub>	0	0	0	0	0	1	0	0	0	1	1	POLH	POLV	0	0	0	Display ON (Note 2)

Notes 1: Input a continuous clock of constant period from the TCK pin. Also, input a horizontal synchronous signal into the HOR pin and a vertical synchronous signal into the VERT pin.  
 2: Matrix-outline display in this data.  
 3: Secure the waiting time of 200ms after releasing  $\overline{AC}$ , and set data from setting the display frequency (setting of the register).

Fig. 19 Example of data setting

M35047-XXXSP/FP

SCREEN CHARACTER and PATTERN DISPLAY CONTROLLERS

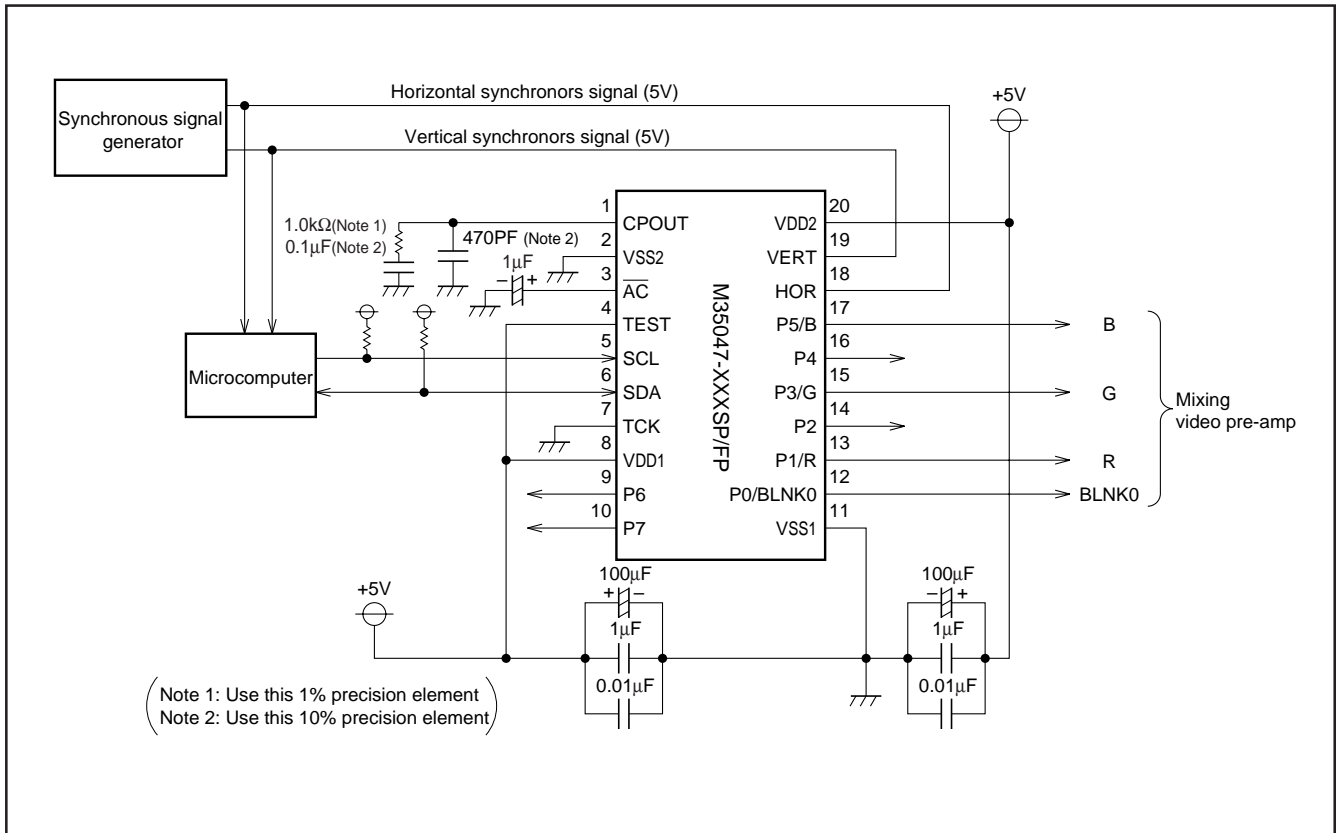

Fig.20 Example of the M35047-XXXSP/FP peripheral circuit (Internal synchronous. At EXCK1 = "0", EXCK0 = "1")

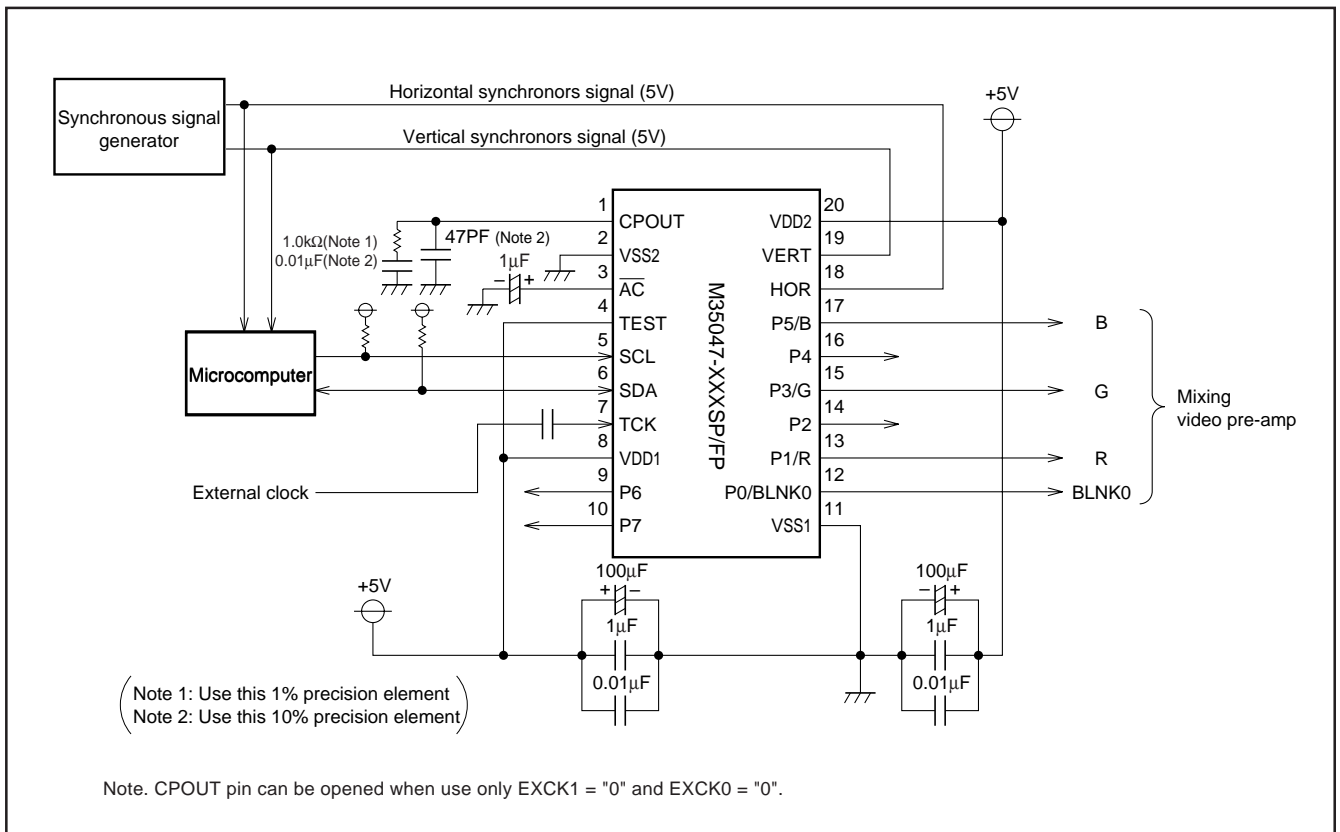

Fig.21 Example of the M35047-XXXSP/FP peripheral circuit (External synchronous. At EXCK1 = "1", EXCK0 = "1")

**DATA INPUT**

(1) I<sup>2</sup>C-Bus communication function

This IC has a built-in data transmission interface which utilizes 2 unidirectional buses. In communications, this IC functions as a slave reception device.

The IC is synchronized with the serial clock (SCL) sent from the master device and receives the data (SDA).

Communications are controlled from the start/stop states. Also, always in put the control byte after attaining the start state.

The below chart shows the start/stop state and control byte configuration.

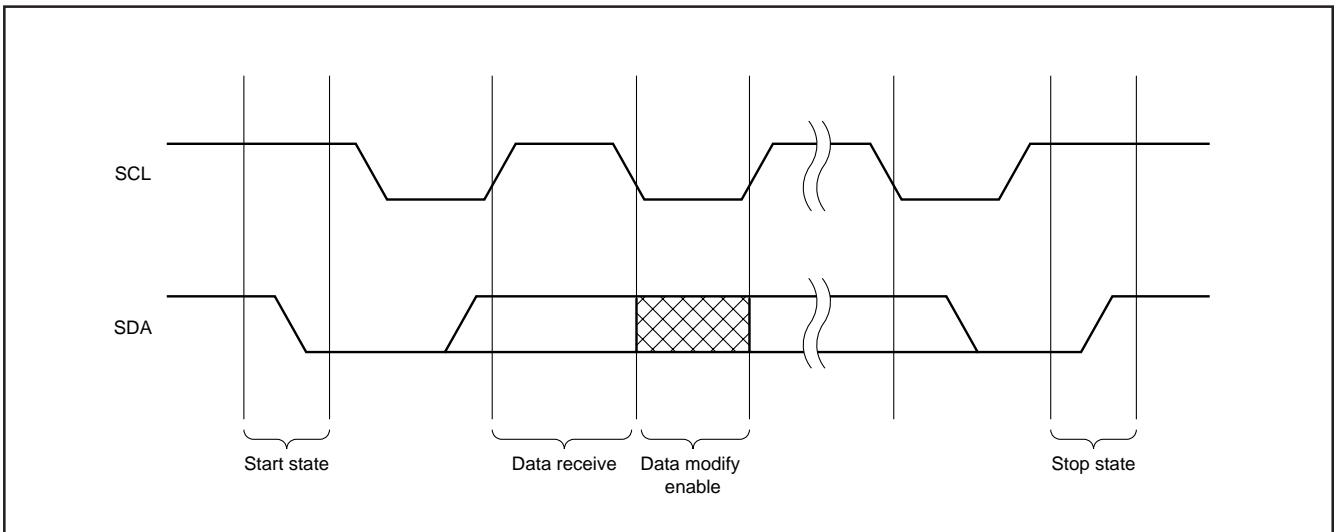

**Fig.22 Start state / Stop state**

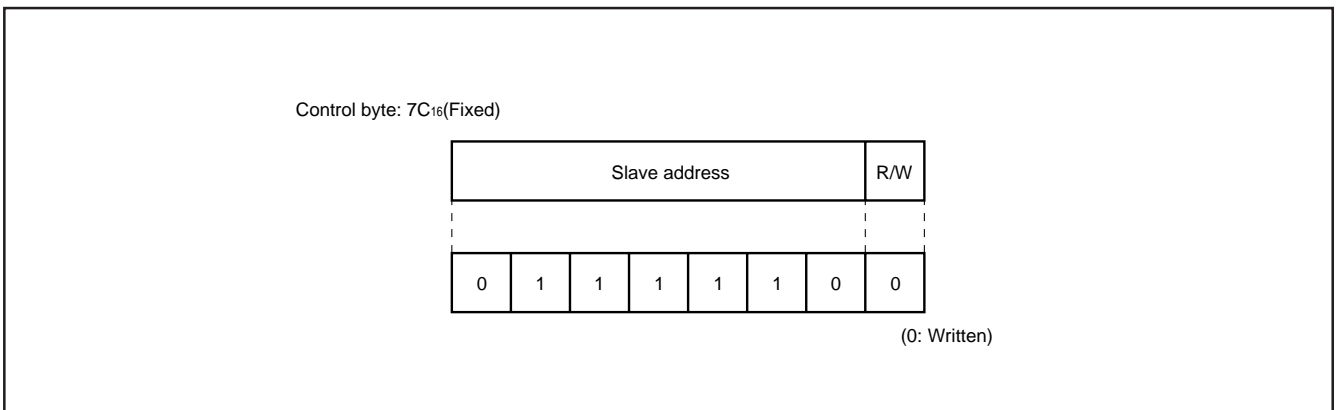
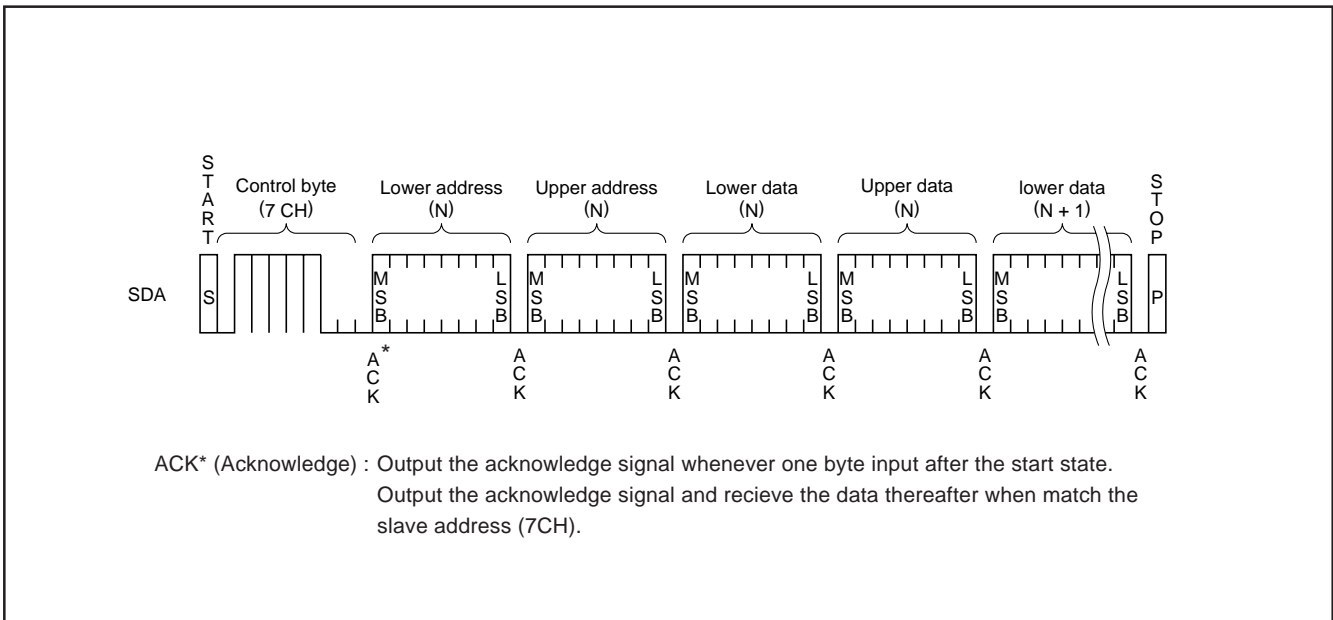

**Fig.23 Control byte configuration**

(2) Data input (Sequence)

- (a) Addresses are consists of 16 bits.
- (b) Data is consists of 16 bits.
- (c) Addresses and data are communicated in 8-bit units. Input the lower 8 bits before the upper 8 bits. Make input from the MSB side.
- (d) After the start state has been attained and the control byte (7CH) received, the next 16 bits (2 bytes) are for inputting the address. Addresses are increased in increments for every 16 bits (2 bytes) of data input thereafter. As a result, it is not necessary to input the address from the second data.

Note: During external synchronous, do not stop the external clock input from the TCK pin while inputting data.



**Fig.24 Data input sequence**

**TIMING REQUIREMENTS**

Data input

Symbol	Parameter	Limits				Unit	Remarks
		Typ. mode		High-speed mode			
		Min.	Max.	Min.	Max.		
fCLK	Clock frequency	0	100	0	400	KHz	
tHIGH	HIGH period of Clock	4000	–	600	–	ns	
tLOW	LOW period of Clock	4700	–	1300	–	ns	
tR	SDA & SCL rise time	–	1000	20+(Note) 0.1CB	300	ns	
tF	SDA & SCL fall time	–	300	20+(Note) 0.1CB	300	ns	
tHD : STA	Hold time at START status	4000	–	600	–	ns	
tsu : STA	Set up time at START status	4700	–	600	–	ns	Only at START state repeating generation
tHD : DAT	Data input hold time	0	–	0	–	ns	
tsu : DAT	Data input setup time	250	–	100	–	ns	
tsu : STO	Set up time at STOP state	4000	–	600	–	ns	
tBUF	Bus release time	4700	–	1300	–	ns	Time must be released bus before next transmission
tSP	Input filter / spike suppress (SDA & SCL pin)	N/A	N/A	0	50	ns	

Note. CB = total capacitance of 1 bus line.

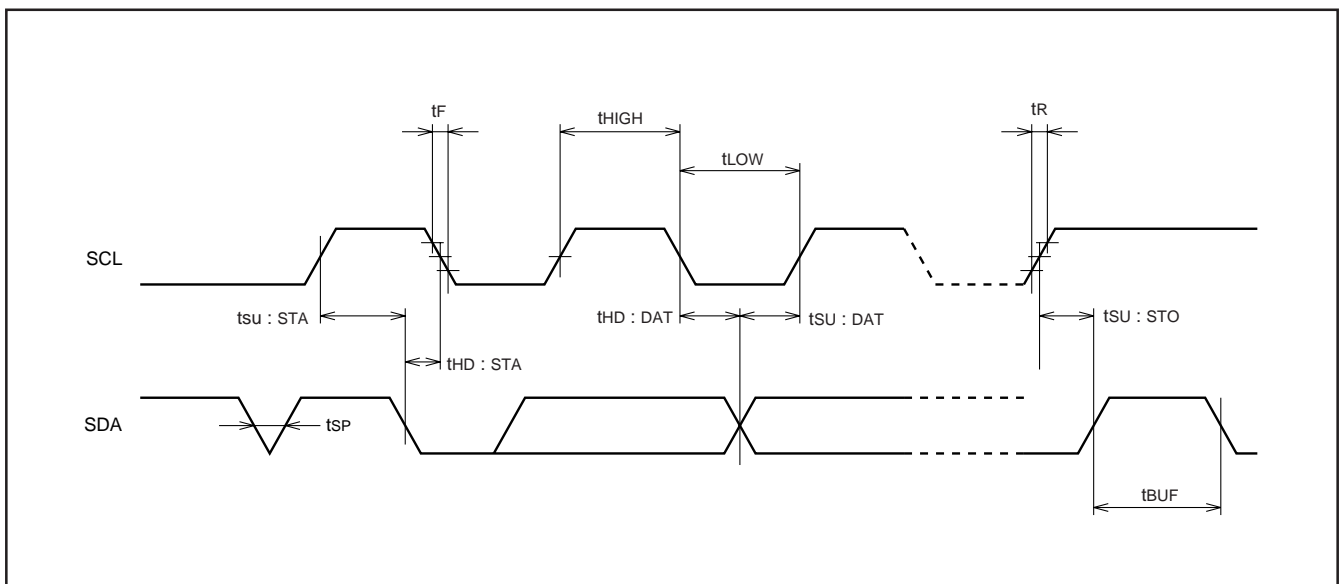

Fig.25 Data input timing



SCREEN CHARACTER and PATTERN DISPLAY CONTROLLERS

**ABSOLUTE MAXIMUM RATINGS** ( $V_{DD} = 5.00V$ ,  $T_a = -20$  to  $+85^\circ C$ , unless otherwise noted)

Symbol	Parameter	Conditions	Ratings	Unit
VDD	Supply voltage	With respect to VSS.	-0.3 to +6.0	V
Vi	Input voltage		$V_{SS} - 0.3 \leq V_i \leq V_{DD} + 0.3$	V
Vo	Output voltage		$V_{SS} \leq V_o \leq V_{DD}$	V
Pd	Power dissipation	$T_a = +25^\circ C$	+300	mW
Topr	Operating temperature		-20 to +85	°C
Tstg	Storage temperature		-40 to +125	°C

**RECOMMENDED OPERATING CONDITIONS** ( $V_{DD} = 5.00V$ ,  $T_a = -20$  to  $+85^\circ C$ , unless otherwise noted)

Symbol	Parameter	Limits			Unit	
		Min.	Typ.	Max.		
VDD	Supply voltage	4.75	5.0	5.25	V	
VIH	"H" level input voltage	$\overline{AC}$ HOR, VERT	0.8VDD	VDD	VDD	V
		SCL, SDA	0.7VDD	VDD	VDD	V
VIL	"L" level input voltage	$\overline{AC}$ HOR, VERT	0	0	0.2VDD	V
		SCL, SDA	0	0	0.3VDD	V
FOSC	Oscillating frequency for display	20.0	—	100.0	MHz	
H.sync	Horizontal synchronous signal input frequency	15.0	—	130.0	kHz	

**ELECTRICAL CHARACTERISTICS** ( $V_{DD} = 5.00V$ ,  $T_a = 25^\circ C$ , unless otherwise noted)

Symbol	Parameter	Test conditions	Limits			Unit	
			Min.	Typ.	Max.		
VDD	Supply voltage	$T_a = -20$ to $+85^\circ C$	4.75	5.0	5.25	V	
IDD	Supply current	$V_{DD} = 5.00V$	—	40	60	mA	
VOH	"H" level output voltage	P0 to P7 (Note1)	3.5	—	—	V	
		CPOUT					$V_{DD} = 4.75V$ , $I_{OH} = -0.05mA$
VOL	"L" level output voltage	P0 to P7 (Note2)	—	—	0.4	V	
		CPOUT					$V_{DD} = 4.75V$ , $I_{OL} = 0.05mA$
		SDA					$V_{DD} = 4.75V$ , $I_{OL} = 3.0mA$
Ri	Pull-up resistance $\overline{AC}$	$V_{DD} = 5.00V$	10	30	100	k $\Omega$	
VTCK	External clock input width	$4.75V \leq V_{DD} \leq 5.25V$	0.6VDD	—	0.9VDD	V	

- Notes 1. The current from the IC must not exceed -0.4 mA/port at any of the port pins (P0 to P7).  
 2. The current flowing into the IC must not exceed 0.4 mA/port at any of port pins (P0 to P7).

**NOTE FOR SUPPLYING POWER**

(1)Timing of power supplying to AC pin

The internal circuit of M35047-XXXSP/FP is reset when the level of the auto clear input pin  $\overline{AC}$  is "L". This pin in hysteresis input with the pull-up resistor.

The timing about power supplying of  $\overline{AC}$  pin is shown in Figure 26.

After supplying the power ( $V_{DD}$  and  $V_{SS}$ ) to M35047-XXXSP/FP and the supply voltage becomes more than  $0.8 \times V_{DD}$ , it needs to keep  $V_{IL}$  time;  $t_w$  of the  $\overline{AC}$  pin for more than 1ms.

Start inputting from microcomputer after  $\overline{AC}$  pin supply voltage becomes more than  $0.8 \times V_{DD}$  and keeping 200ms wait time.

(2)Timing of power supplying to  $V_{DD1}$  and  $V_{DD2}$ .

Supply power to  $V_{DD1}$  and  $V_{DD2}$  at the same time.

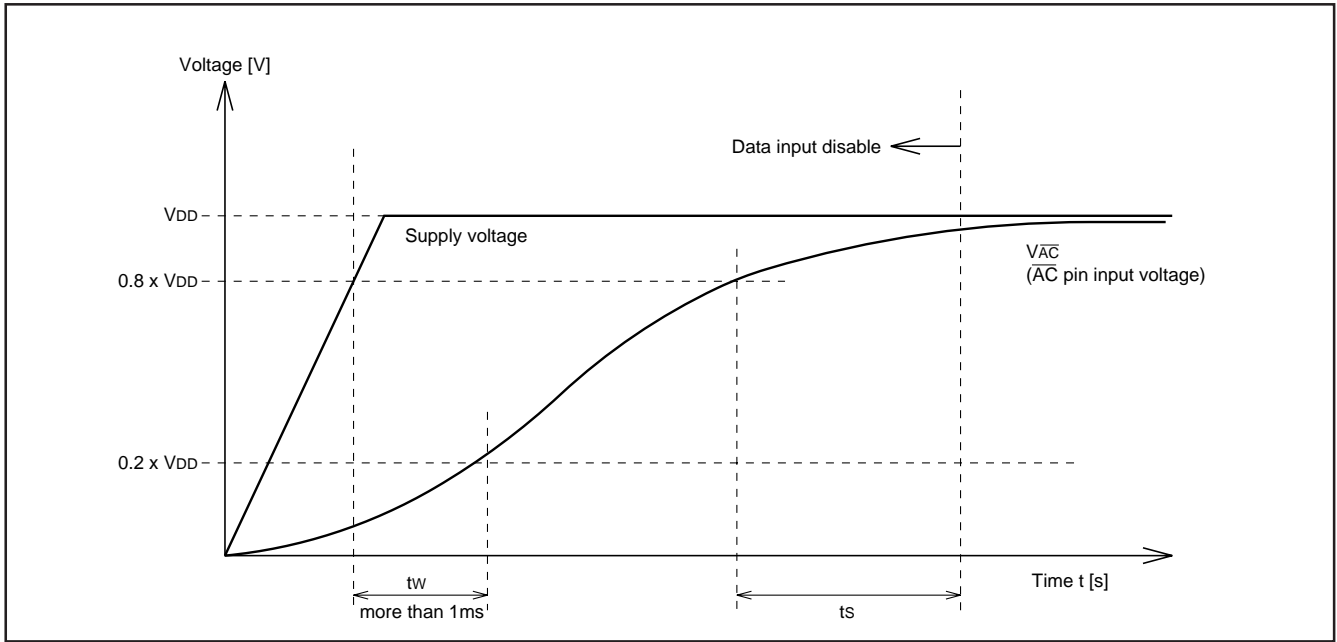

Fig.26 Timing of power supplying to AC pin

**PRECAUTION FOR USE**

Notes on noise and latch-up

In order to avoid noise and latch-up, connect a bypass capacitor ( $\approx 0.1\mu F$ ) directly between the  $V_{DD1}$  pin and  $V_{SS1}$  pin, and the  $V_{DD2}$  pin and  $V_{SS2}$  pin using a heavy wire.

Note for waveform timing of the horizontal signals to the HOR pin

Set horizontal synchronous signal\* waveform timing to under 5ns and input to HOR pin.

Set only the side which set by B/F register waveform timing under 5ns and input to HOR pin.

\*: Set front porch edge or back porch edge by B/F register.

**DATA REQUIRED FOR MASK ROM ORDERING**

Please send the following data for mask orders.

- (1) M35047-XXXSP/FP mask ROM order confirmation form
- (2) 20P4B mark specification form
- (3) 20P2Q-A mark specification form
- (4) ROM data : EPROMs or floppy disks

\*In the case of EPROMs, thres sets of EPROMs are required per pattern.

\*In the case of floppy disks, 3.5-inch 2HD disk (1BM format) is required per pattern.

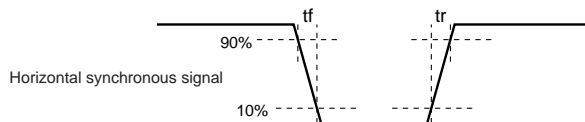

**STANDARD ROM TYPE : M35047-002SP/FP**

M35047-002SP/FP is a standard ROM type of M35047-XXXSP/FP.  
The character patterns are fixed to the contents of Figure 27 to 30.

SCREEN CHARACTER and PATTERN DISPLAY CONTROLLERS

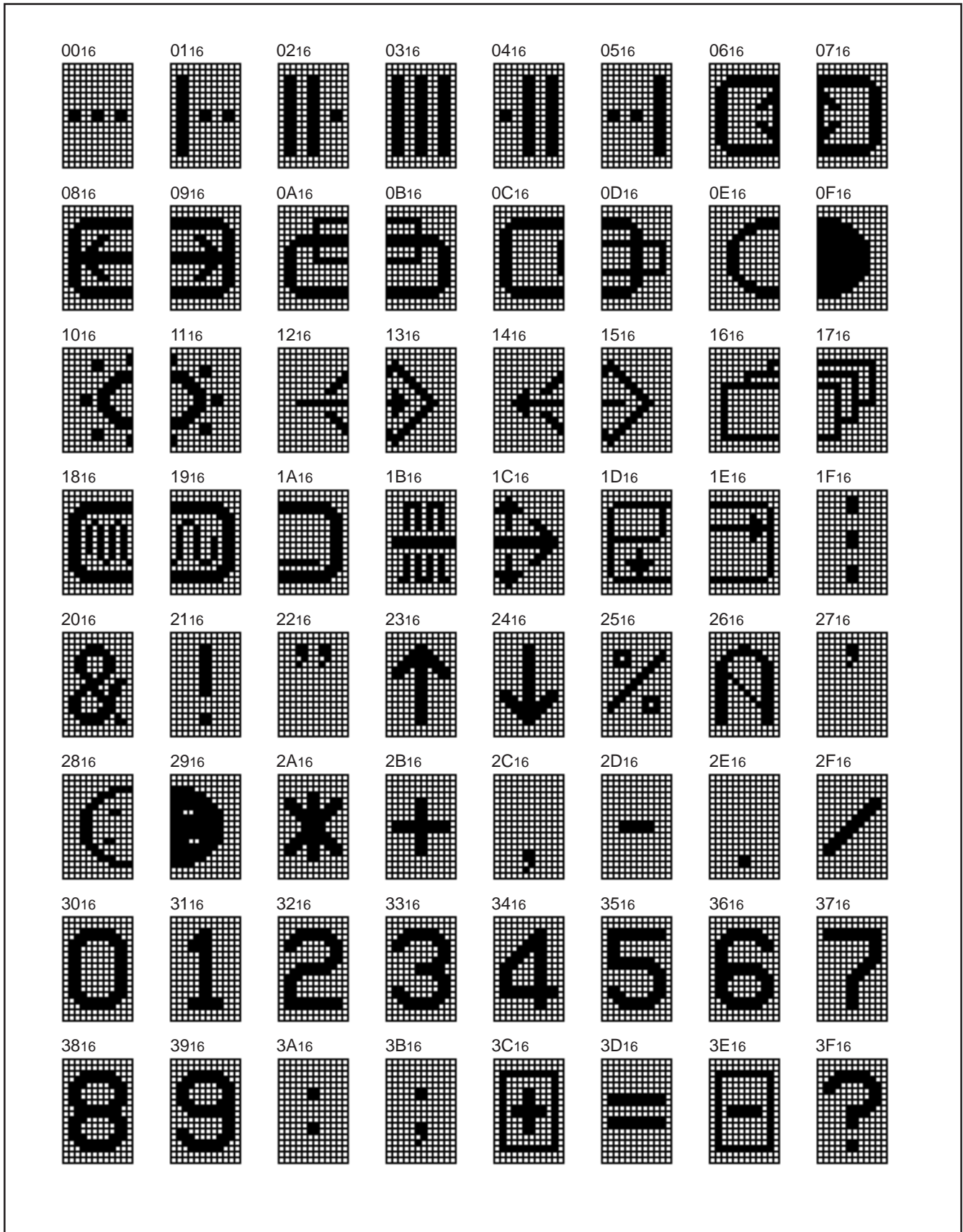

Fig.27 M35047-002SP/FP character patterns (1)

SCREEN CHARACTER and PATTERN DISPLAY CONTROLLERS



Fig.28 M35047-002SP/FP character patterns (2)

SCREEN CHARACTER and PATTERN DISPLAY CONTROLLERS

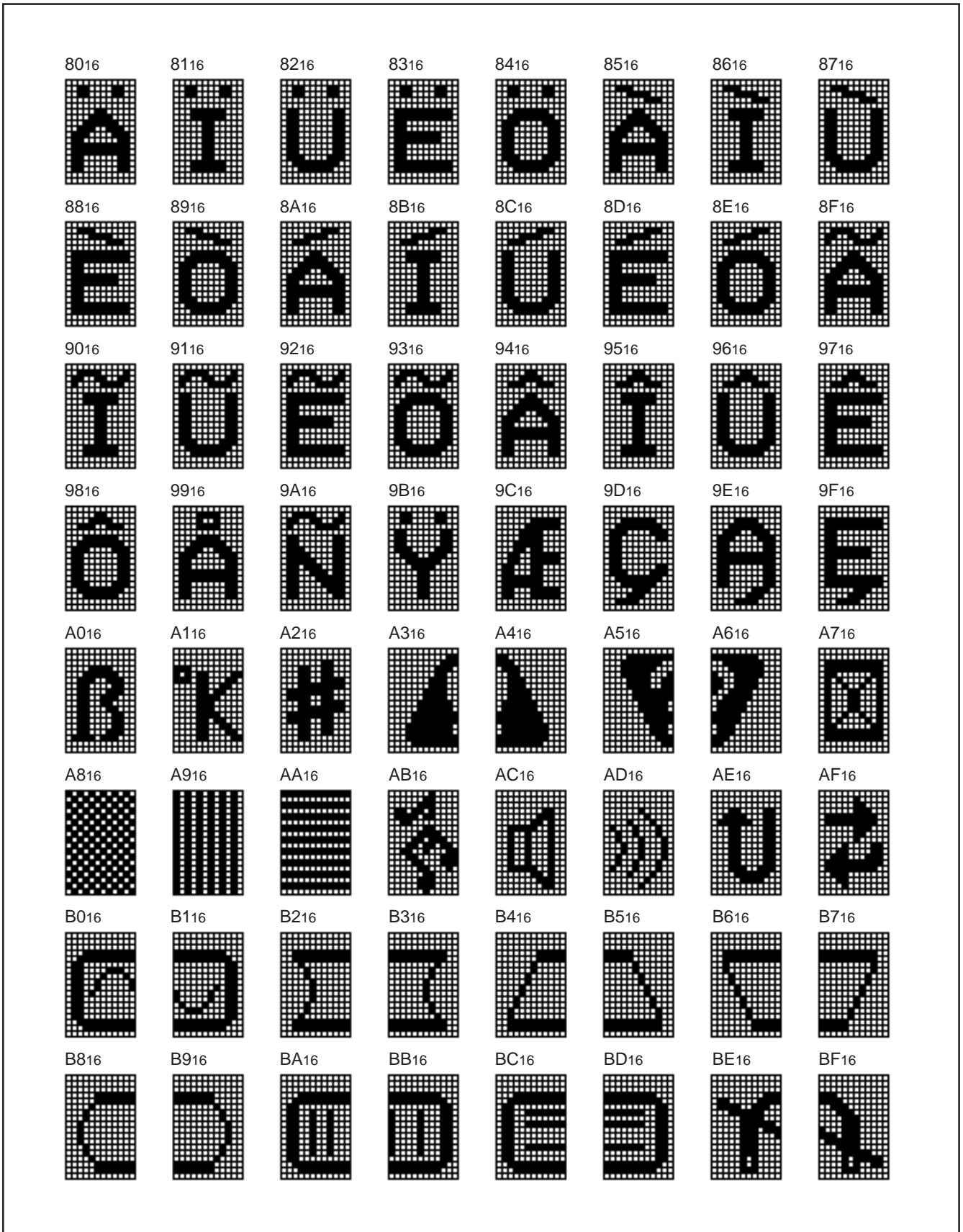

Fig.29 M35047-002SP/FP character patterns (3)

SCREEN CHARACTER and PATTERN DISPLAY CONTROLLERS



Fig.30 M35047-002SP/FP character patterns (4)

# M35047-XXXSP/FP

SCREEN CHARACTER and PATTERN DISPLAY CONTROLLERS

GZZ-SH56-34B<92A0>

Mask ROM number	
-----------------	--

**MASK ROM CONFIRMATION FORM  
SCREEN DISPLAY IC M35047-XXXSP/FP  
MITSUBISHI ELECTRIC**

Receipt	Data :	
	Section head signature	Supervisor signature

Note : Please fill in all items marked \*, □.

* Customer	Company name	TEL (      )	Issuance signature	Submitted by	Supervisor
	Data issued	Date :			

\* 1. Confirmation

Confirm the Character Font Preparation Program in Mitsubishi Sales Sites.  
Three EPROMs are required for each pattern if this order is performed by EPROMs.  
One floppy disk is required for each pattern if this order is performed by a floppy disk.

□ Ordering by EPROMs

If at least two of the three sets of EPROMs submitted contain identical data, we will produce masks based on this data. We shall assume the responsibility for errors only if the mask ROM data on the products we produce differs from this data. Thus, extreme care must be taken to verify the data in the submitted EPROMs (27512 type used).

- (1) The font data prepared by the Character Font Preparation Program is saved as a binary type object file (addresses 0000h to FFFFh) and a hex type object file . Three sets of these EPROMs are required.
- (2) Attach the erase protect seals on three EPROMs. Each seal bears the type name (M35047), and ROM No. (-...SP/FP).

Checksum code for entire EPROM 

--	--	--	--

 (hexadecimal notation)

Save file name 

M	0	4	7	R			
---	---	---	---	---	--	--	--

 . 

V		
---	--	--

 (equal or less than eight characters )

□ Ordering by floppy disk

We will produce masks based on the mask files generated by the mask file generating utility. We shall assume the responsibility for errors only if the mask ROM data on the products we produce differs from this mask file. Thus, extreme care must be taken to verify the mask file in the submitted floppy disk.

The mask files forms hex-file made by the character font preparation program in the mask file generation utility. Submit the mask file after be saved in the floppy disk.

The submitted floppy disk must be 3.5-inch 2HD type and DOS/V format. And the number of the mask files must be one in one floppy disk.

File code 

--	--	--	--	--	--	--	--

 (hexadecimal notation)

Mask file name 

--	--	--	--	--	--	--	--

 .MSK (equal or less than eight characters)

\* 2. Select the marking type (Check ✓ in the appropriate box).

- Special Mark  ..... Fill in the Mark Specification Form (20P4B for M35047-XXXSP, 20P2Q-A for M35047-XXXFP) and attach to the Mask ROM Confirmation Form.
- Standard Mark  ..... No writing is required.

\* 3. Select the package type (Check ✓ in the appropriate box).

- ..... SDIP (M35047-XXXSP)
- ..... SSOP (M35047-XXXFP)

\* 4. Comments



\* 5. Test patterns

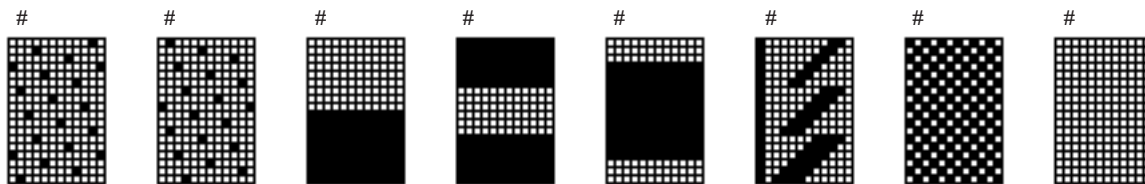

\* 6. Character patterns  
(See the next page)

# M35047-XXXSP/FP

SCREEN CHARACTER and PATTERN DISPLAY CONTROLLERS

---

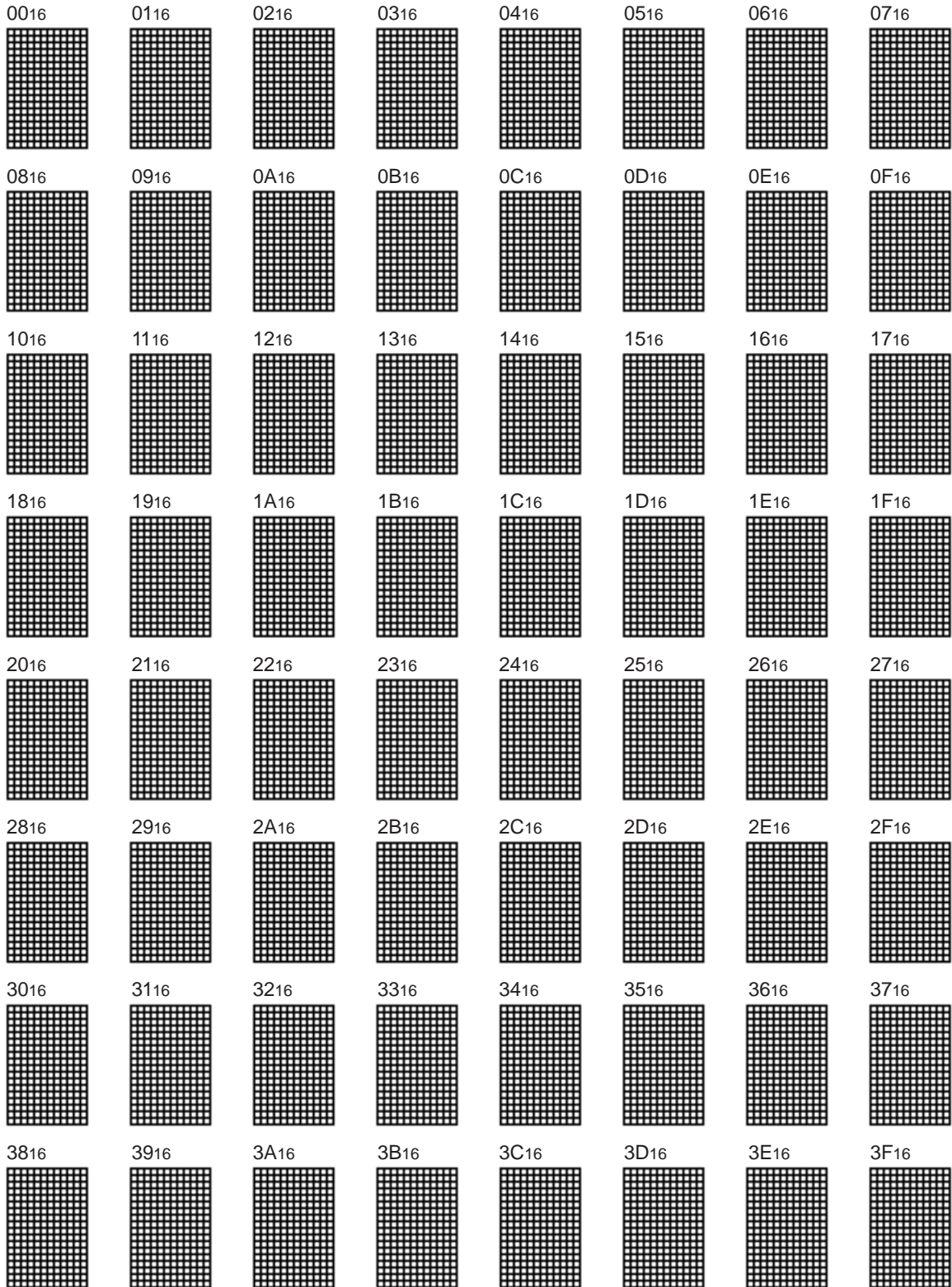

# M35047-XXXSP/FP

SCREEN CHARACTER and PATTERN DISPLAY CONTROLLERS

---

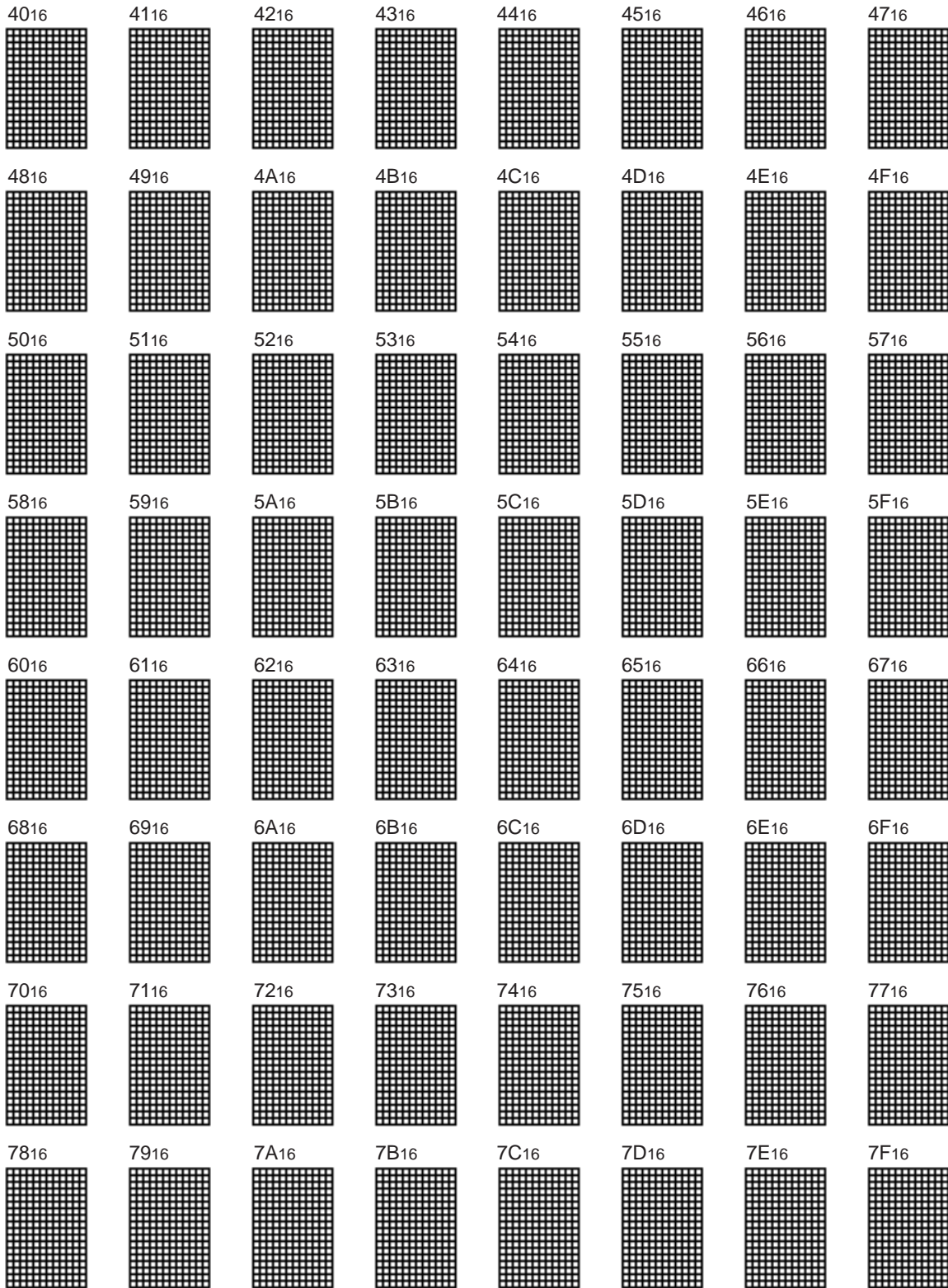

**M35047-XXXSP/FP**

SCREEN CHARACTER and PATTERN DISPLAY CONTROLLERS

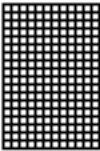
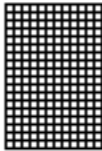
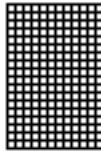
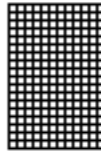
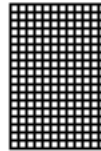
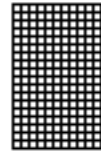
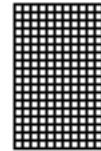
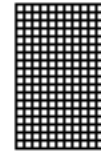
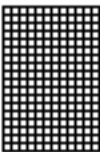
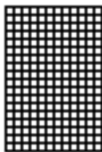
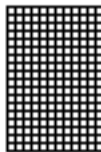
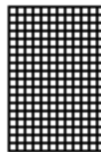
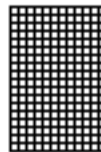
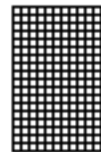
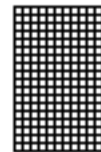
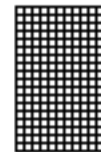
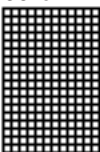
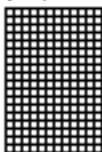
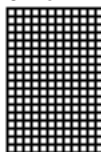
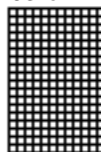
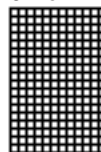
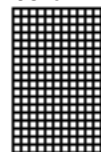
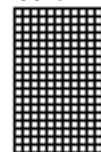
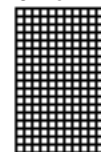
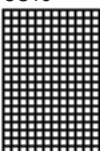
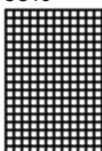
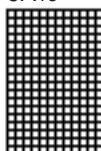
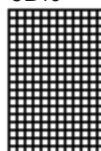
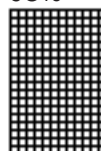
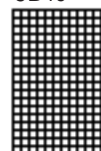
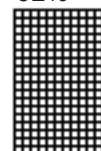
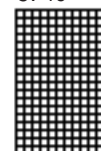
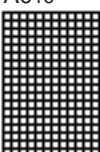
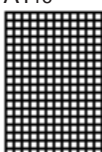
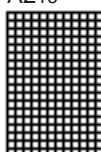
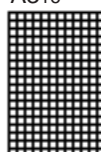
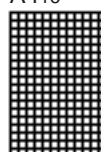
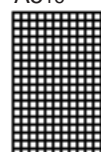
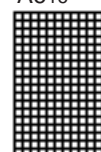
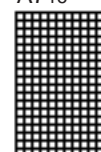
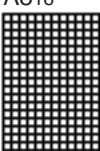
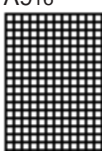
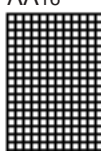
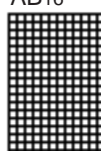
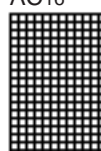
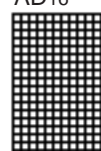
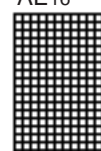
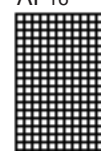
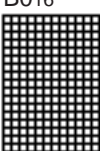
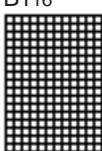
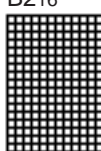
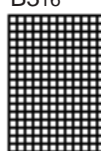
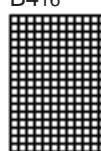
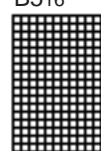
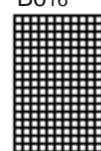
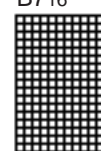
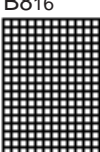
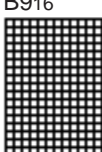
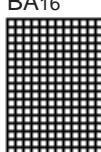
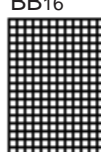
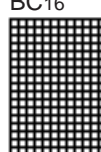
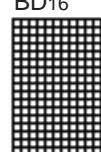
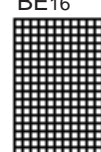
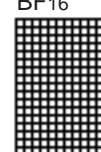
8016 	8116 	8216 	8316 	8416 	8516 	8616 	8716 
8816 	8916 	8A16 	8B16 	8C16 	8D16 	8E16 	8F16 
9016 	9116 	9216 	9316 	9416 	9516 	9616 	9716 
9816 	9916 	9A16 	9B16 	9C16 	9D16 	9E16 	9F16 
A016 	A116 	A216 	A316 	A416 	A516 	A616 	A716 
A816 	A916 	AA16 	AB16 	AC16 	AD16 	AE16 	AF16 
B016 	B116 	B216 	B316 	B416 	B516 	B616 	B716 
B816 	B916 	BA16 	BB16 	BC16 	BD16 	BE16 	BF16 

**M35047-XXXSP/FP**

SCREEN CHARACTER and PATTERN DISPLAY CONTROLLERS

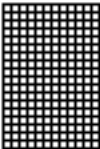
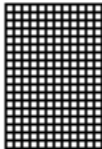
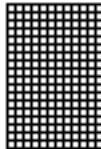
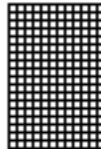
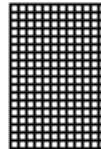
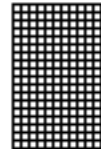
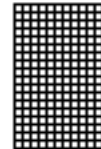
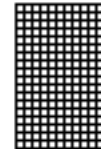
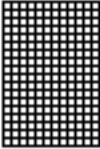
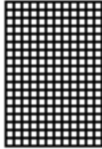
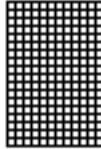
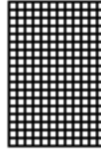
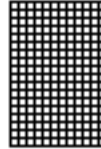
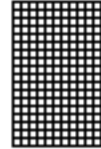
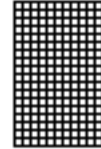
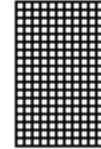
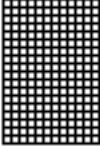
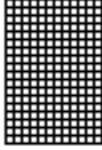
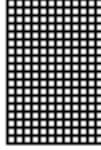
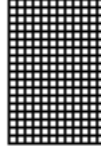
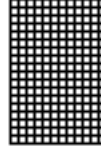
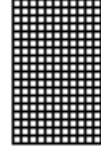
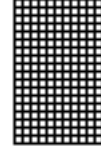
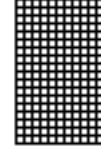
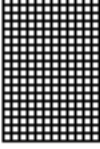
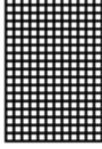
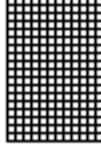
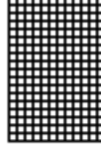
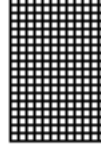
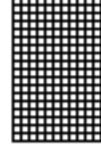
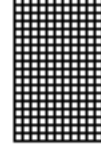
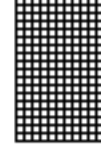
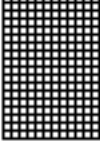
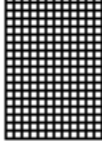
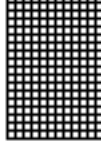
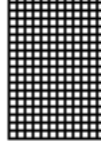
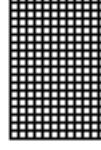
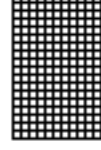
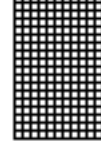
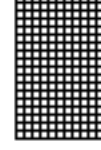
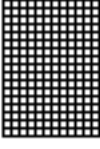
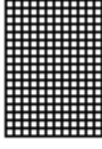
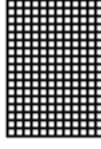
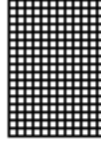
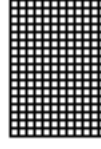
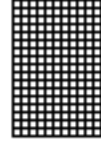
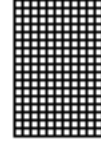
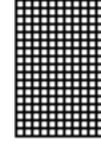
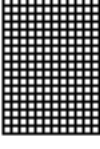
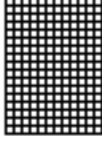
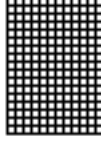
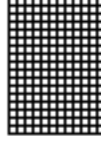
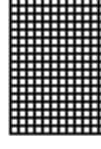
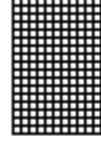
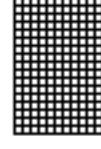
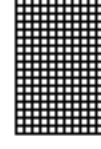
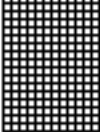
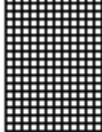
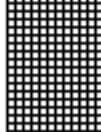
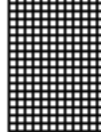
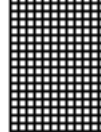
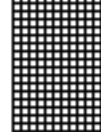
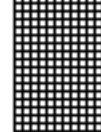
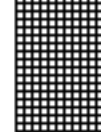
C016	C116	C216	C316	C416	C516	C616	C716
							
C816	C916	CA16	CB16	CC16	CD16	CE16	CF16
							
D016	D116	D216	D316	D416	D516	D616	D716
							
D816	D916	DA16	DB16	DC16	DD16	DE16	DF16
							
E016	E116	E216	E316	E416	E516	E616	E716
							
E816	E916	EA16	EB16	EC16	ED16	EE16	EF16
							
F016	F116	F216	F316	F416	F516	F616	F716
							
F816	F916	FA16	FB16	FC16	FD16	FE16	FF16blank
							

**20P4B (20-PIN SDIP) MARK SPECIFICATION FORM**

Mitsubishi IC catalog name

Please choose one of the marking types below (A, B, C), and enter the Mitsubishi IC catalog name and the special mark (if needed).

**A. Standard Mitsubishi Mark**

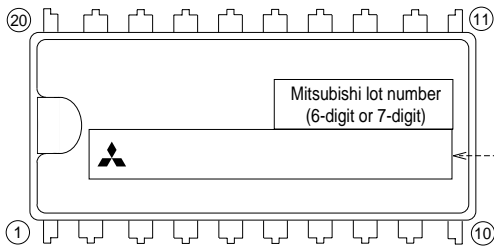

Mitsubishi IC catalog name

**B. Customer's Parts Number + Mitsubishi IC Catalog Name**

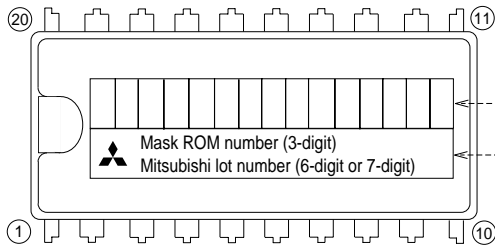

Customer's Parts Number

Note: The fonts and size of characters are standard Mitsubishi type.  
Mitsubishi IC catalog name and Mitsubishi lot number

Notes 1 : The mark field should be written right aligned.

2 : The fonts and size of characters are standard Mitsubishi type.

3 : Customer's Parts Number can be up to 13 characters: Only 0 to 9, A to Z, +, -, /, (, ), &, ©, . (period), and , (comma) are usable.

4 : If the Mitsubishi logo is not required, check the box below.

Mitsubishi logo is not required

**C. Special Mark Required**

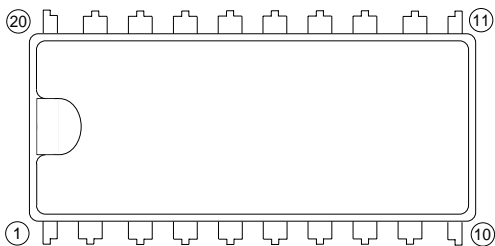

Note 1 : If the Special Mark is to be Printed, indicate the desired layout of the mark in the left figure. The layout will be duplicated as close as possible.

Mitsubishi lot number (6-digit, or 7-digit) and Mask ROM number (3-digit) are always marked.

2 : If the customer's trade mark logo must be used in the Special Mark, check the box below.

Please submit a clean original of the logo.

For the new special character fonts, a clean font original (ideally logo drawing) must be submitted.

Special logo required



**20P2Q-A (20-PIN SSOP) MARK SPECIFICATION FORM**

Mitsubishi IC catalog name

Please choose one of the marking types below (A, B, C), and enter the Mitsubishi IC catalog name and the special mark (if needed).

**A. Standard Mitsubishi Mark**

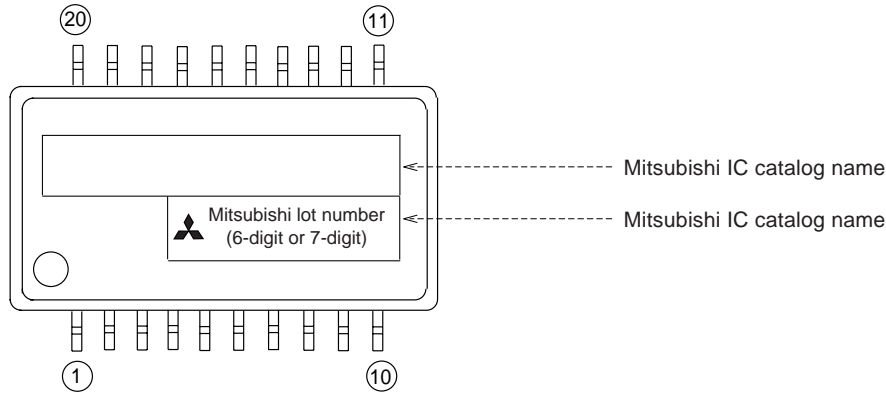

**B. Customer's Parts Number + Mitsubishi IC Catalog Name**

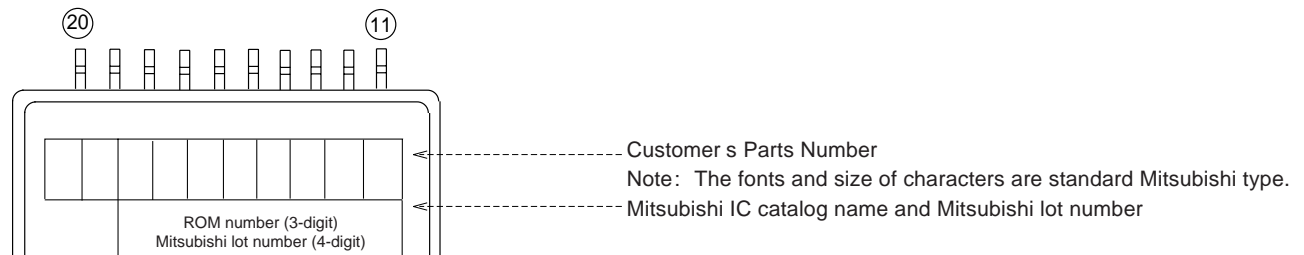

- Notes 1 : The mark field should be written right aligned.  
 2 : The fonts and size of characters are standard Mitsubishi type.  
 3 : Customer's Parts Number can be up to 10 characters: Only 0 to 9, A to Z, +, -, /, (, ), &, ', . (period), and , (comma) are usable.  
 4 : If the Mitsubishi logo is not required, check the box below.

Mitsubishi logo is not required

**C. Special Mark Required**

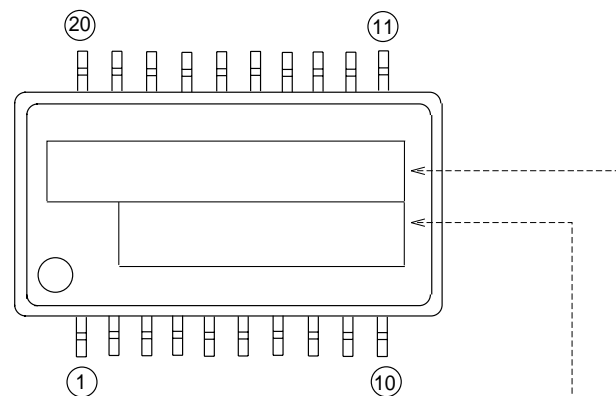

- Note 1 : If the Special Mark is to be Printed, indicate the desired layout of the mark in the left figure. The layout will be duplicated as close as possible.  
 Mitsubishi lot number (4-digit) and Mask ROM number (3-digit) are always marked.  
 2 : If the customer's trade mark logo must be used in the Special Mark, check the box below.  
 Please submit a clean original of the logo.  
 For the new special character fonts, a clean font original (ideally logo drawing) must be submitted.

Special logo required

Special Mark (Customer's Trade Mark)

Mitsubishi IC catalog name

PACKAGE OUTLINE

20P4B

Plastic 20pin 300mil SDIP

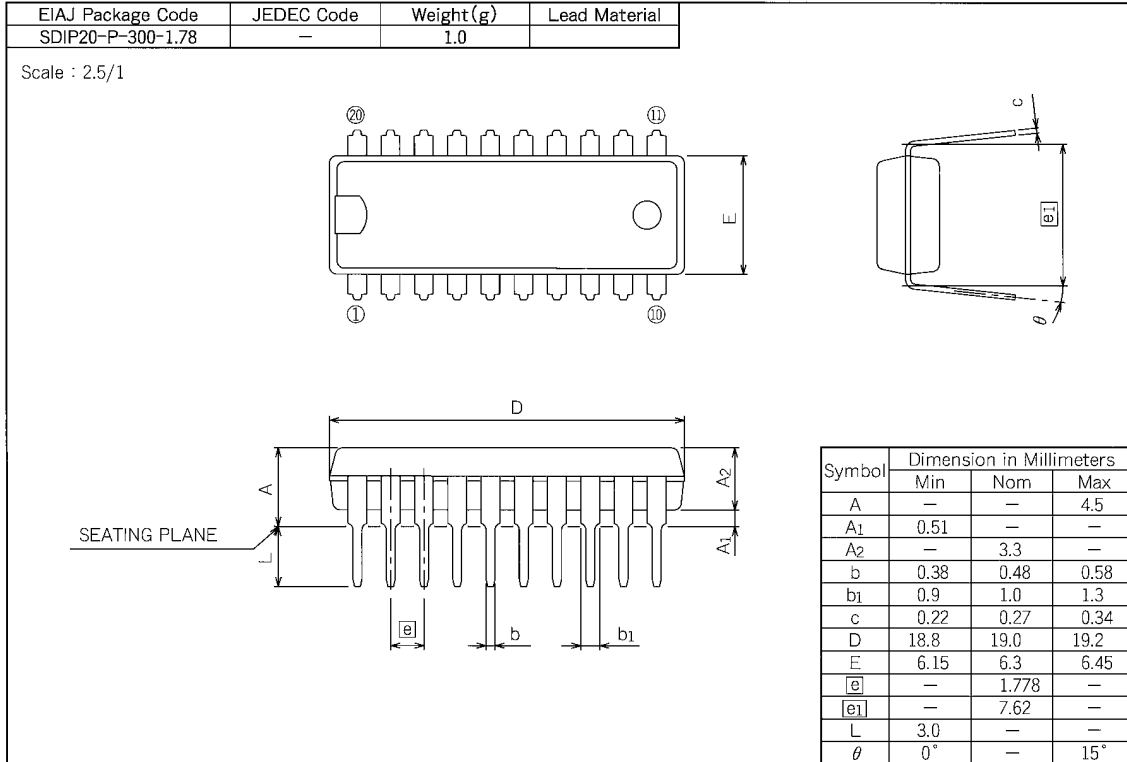

20P2Q-A

Plastic 20pin 300mil SSOP

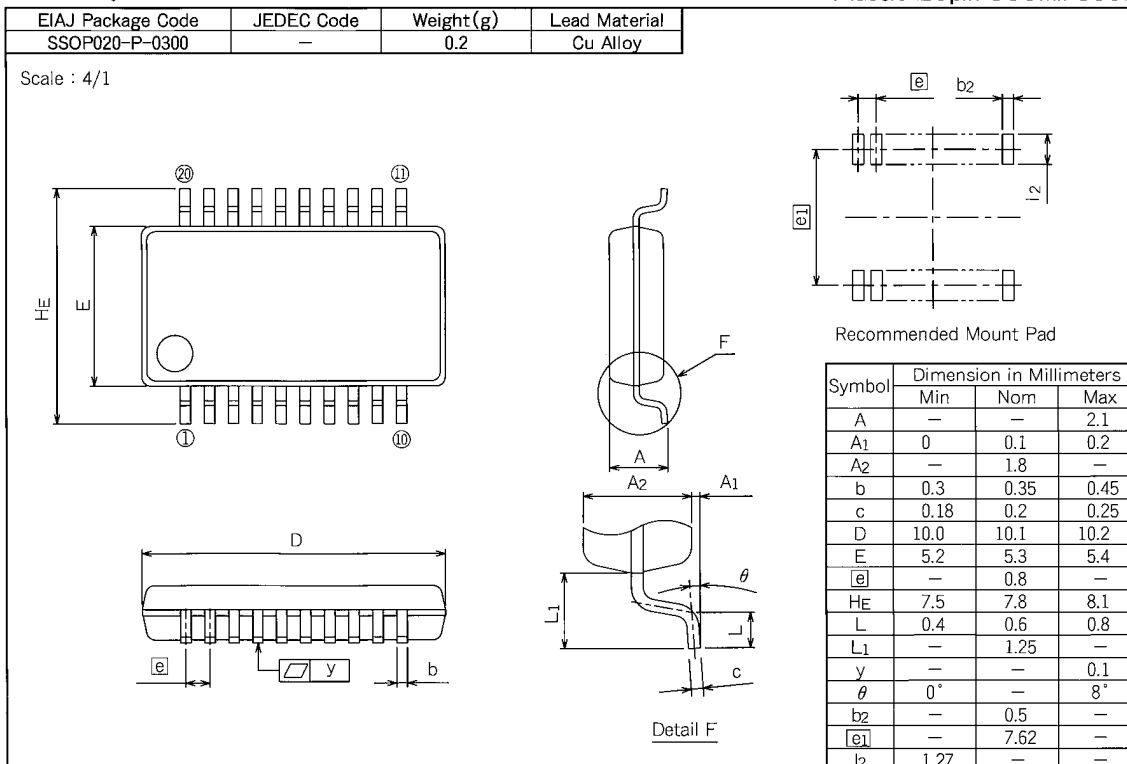





**Keep safety first in your circuit designs!**

- Mitsubishi Electric Corporation puts the maximum effort into making semiconductor products better and more reliable, but there is always the possibility that trouble may occur with them. Trouble with semiconductors may lead to personal injury, fire or property damage. Remember to give due consideration to safety when making your circuit designs, with appropriate measures such as (i) placement of substitutive, auxiliary circuits, (ii) use of non-flammable material or (iii) prevention against any malfunction or mishap.

**Notes regarding these materials**

- These materials are intended as a reference to assist our customers in the selection of the Mitsubishi semiconductor product best suited to the customer's application; they do not convey any license under any intellectual property rights, or any other rights, belonging to Mitsubishi Electric Corporation or a third party.
- Mitsubishi Electric Corporation assumes no responsibility for any damage, or infringement of any third-party's rights, originating in the use of any product data, diagrams, charts, programs, algorithms, or circuit application examples contained in these materials.
- All information contained in these materials, including product data, diagrams, charts, programs and algorithms represents information on products at the time of publication of these materials, and are subject to change by Mitsubishi Electric Corporation without notice due to product improvements or other reasons. It is therefore recommended that customers contact Mitsubishi Electric Corporation or an authorized Mitsubishi Semiconductor product distributor for the latest product information before purchasing a product listed herein.
- The information described here may contain technical inaccuracies or typographical errors. Mitsubishi Electric Corporation assumes no responsibility for any damage, liability, or other loss rising from these inaccuracies or errors. Please also pay attention to information published by Mitsubishi Electric Corporation by various means, including the Mitsubishi Semiconductor home page (<http://www.mitsubishichips.com>).
- When using any or all of the information contained in these materials, including product data, diagrams, charts, programs, and algorithms, please be sure to evaluate all information as a total system before making a final decision on the applicability of the information and products. Mitsubishi Electric Corporation assumes no responsibility for any damage, liability or other loss resulting from the information contained herein.
- Mitsubishi Electric Corporation semiconductors are not designed or manufactured for use in a device or system that is used under circumstances in which human life is potentially at stake. Please contact Mitsubishi Electric Corporation or an authorized Mitsubishi Semiconductor product distributor when considering the use of a product contained herein for any specific purposes, such as apparatus or systems for transportation, vehicular, medical, aerospace, nuclear, or undersea repeater use.
- The prior written approval of Mitsubishi Electric Corporation is necessary to reprint or reproduce in whole or in part these materials.
- If these products or technologies are subject to the Japanese export control restrictions, they must be exported under a license from the Japanese government and cannot be imported into a country other than the approved destination. Any diversion or reexport contrary to the export control laws and regulations of Japan and/or the country of destination is prohibited.
- Please contact Mitsubishi Electric Corporation or an authorized Mitsubishi Semiconductor product distributor for further details on these materials or the products contained therein.



REVISION DESCRIPTION LIST

M35047-XXXSP/FP DATA SHEET

Rev. No.	Revision Description	Rev. date
1.0	First Edition	980402
1.1	P47 20P2Q-A (20-PIN SSOP) MARK SPECIFICATION FORM B: Note 4 added	000707