

Built-in Diode at C-E
Low $V_{CE(sat)}$

2SC4065

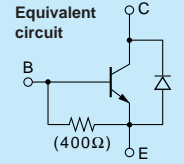

Silicon NPN Epitaxial Planar Transistor (Complement to type 2SA1568)

Application : DC Motor Driver and General Purpose

Absolute maximum ratings ($T_a=25^\circ\text{C}$)

Symbol	2SC4065	Unit
V_{CBO}	60	V
V_{CEO}	60	V
V_{EBO}	6	V
I_C	± 12	A
I_B	3	A
P_C	35($T_C=25^\circ\text{C}$)	W
T_J	150	$^\circ\text{C}$
T_{stg}	-55 to +150	$^\circ\text{C}$

Electrical Characteristics ($T_a=25^\circ\text{C}$)

Symbol	Conditions	2SC4065	Unit
I_{CBO}	$V_{CB}=60\text{V}$	100max	μA
I_{EBO}	$V_{EB}=6\text{V}$	60max	mA
$V_{(BR)CEO}$	$I_C=25\text{mA}$	60min	V
h_{FE}	$V_{CE}=1\text{V}, I_C=6\text{A}$	50min	
$V_{CE(sat)}$	$I_C=6\text{A}, I_B=1.3\text{A}$	0.35max	V
V_{FEC}	$V_{ECO}=10\text{A}$	2.5max	V
f_r	$V_{CE}=12\text{V}, I_E=-0.5\text{A}$	24typ	MHz
C_{OB}	$V_{CB}=10\text{V}, f=1\text{MHz}$	180typ	PF

Typical Switching Characteristics (Common Emitter)

V_{CC} (V)	R_L (Ω)	I_C (A)	V_{BB1} (V)	V_{BB2} (V)	I_{B1} (A)	I_{B2} (A)	t_{on} (μs)	t_{stg} (μs)	t_f (μs)
24	4	6	10	-5	0.12	-0.12	0.6typ	1.4typ	0.4typ

External Dimensions FM20(TO220F)

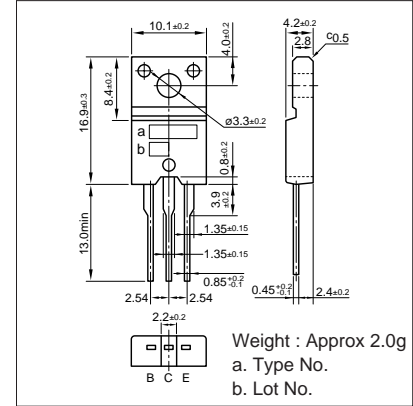

I_C-V_{CE} Characteristics (Typical)

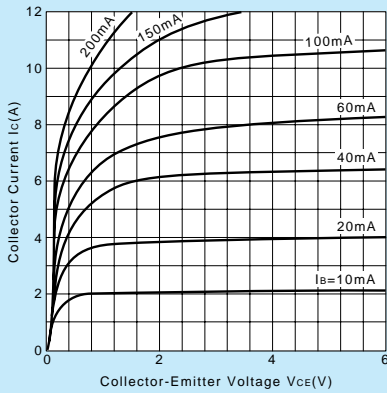

$V_{CE(sat)}-I_B$ Characteristics (Typical)

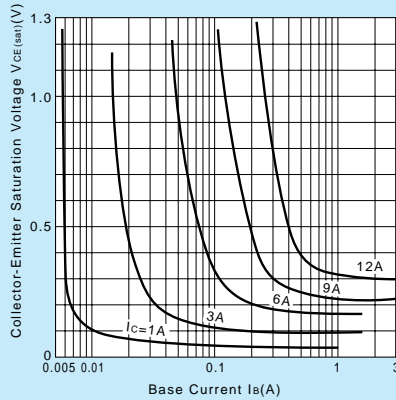

I_C-V_{BE} Temperature Characteristics (Typical)

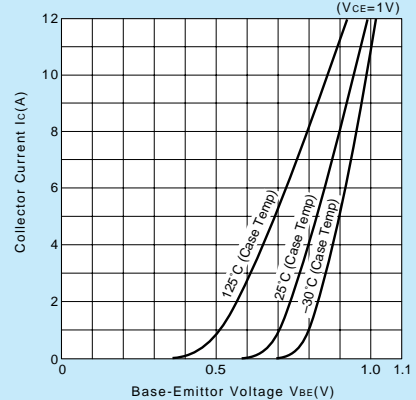

$h_{FE}-I_C$ Characteristics (Typical)

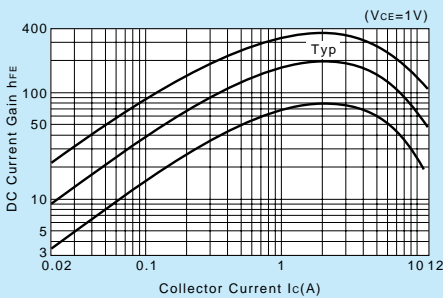

$h_{FE}-I_C$ Temperature Characteristics (Typical)

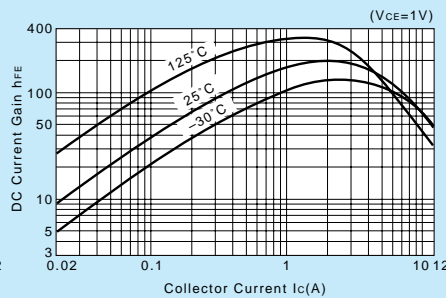

$\theta_{j-a}-t$ Characteristics

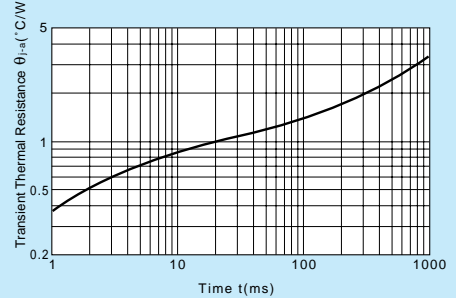

f_r-I_E Characteristics (Typical)

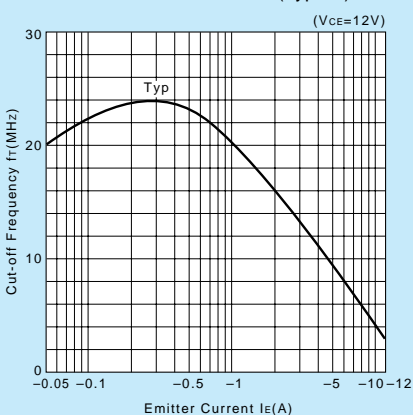

Safe Operating Area (Single Pulse)

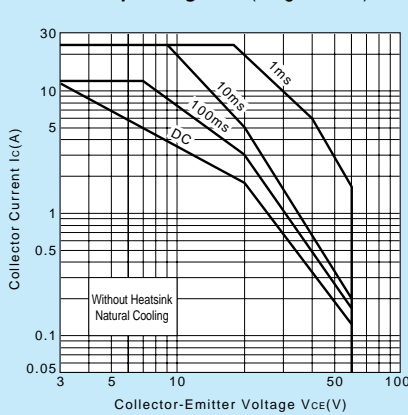

P_C-T_a Derating

