

General Purpose Transistor

- Pb-Free Package May be Available. The G-Suffix Denotes a Pb-Free Lead Finish

LMBT3904LT1

ORDERING INFORMATION

Device	Package	Shipping
LMBT3904LT1	SOT-23	3000/Tape & Reel
LMBT3904LT1G	SOT-23	3000/Tape & Reel

MAXIMUM RATINGS

Rating	Symbol	Value	Unit
Collector-Emitter Voltage	V_{CEO}	40	Vdc
Collector-Base Voltage	V_{CBO}	60	Vdc
Emitter-Base Voltage	V_{EBO}	6.0	Vdc
Collector Current — Continuous	I_C	200	mAdc

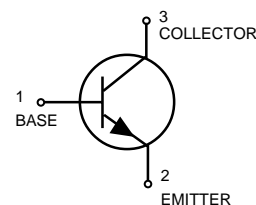

THERMAL CHARACTERISTICS

Characteristic	Symbol	Max	Unit
Total Device Dissipation FR-5 Board, (1) $T_A = 25^\circ\text{C}$	P_D	225	mW
Derate above 25°C		1.8	mW/ $^\circ\text{C}$
Thermal Resistance, Junction to Ambient	$R_{\theta JA}$	556	$^\circ\text{C}/\text{W}$
Total Device Dissipation Alumina Substrate, (2) $T_A = 25^\circ\text{C}$	P_D	300	mW
Derate above 25°C		2.4	mW/ $^\circ\text{C}$
Thermal Resistance, Junction to Ambient	$R_{\theta JA}$	417	$^\circ\text{C}/\text{W}$
Junction and Storage Temperature	T_J, T_{stg}	-55 to +150	$^\circ\text{C}$

DEVICE MARKING

LMBT3904LT1 = 1AM

ELECTRICAL CHARACTERISTICS ($T_A = 25^\circ\text{C}$ unless otherwise noted.)

Characteristic	Symbol	Min	Max	Unit
----------------	--------	-----	-----	------

OFF CHARACTERISTICS

Collector-Emitter Breakdown Voltage(3) ($I_C = 1.0 \text{ mAdc}$)	$V_{(BR)CEO}$	40	—	Vdc
Collector-Base Breakdown Voltage ($I_C = 10 \mu\text{Adc}$)	$V_{(BR)CBO}$	60	—	Vdc
Emitter-Base Breakdown Voltage ($I_E = 10 \mu\text{Adc}$)	$V_{(BR)EBO}$	6.0	—	Vdc
Base Cutoff Current ($V_{CE} = 30 \text{ Vdc}, V_{EB} = 3.0 \text{ Vdc}$)	I_{BL}	—	50	nAdc
Collector Cutoff Current ($V_{CE} = 30 \text{ Vdc}, V_{BE} = 3.0 \text{ Vdc}$)	I_{CEX}	—	50	nAdc

1. FR-5 = $1.0 \times 0.75 \times 0.062 \text{ in.}$

2. Alumina = $0.4 \times 0.3 \times 0.024 \text{ in.}$ 99.5% alumina.

3. Pulse Test: Pulse Width $\leq 300 \mu\text{s}$, Duty Cycle $\leq 2.0\%$.

LMBT3904LT1
ELECTRICAL CHARACTERISTICS ($T_A = 25^\circ\text{C}$ unless otherwise noted) (Continued)

Characteristic	Symbol	Min	Max	Unit
DC CHARACTERISTICS (3)				
DC Current Gain(1) ($I_C = 0.1 \text{ mAdc}$, $V_{CE} = 1.0 \text{ Vdc}$)	h_{FE}	40	—	—
($I_C = 1.0 \text{ mAdc}$, $V_{CE} = 1.0 \text{ Vdc}$)		70	—	
($I_C = 10 \text{ mAdc}$, $V_{CE} = 1.0 \text{ Vdc}$)		100	300	
($I_C = 50 \text{ mAdc}$, $V_{CE} = 1.0 \text{ Vdc}$)		60	—	
($I_C = 100 \text{ mAdc}$, $V_{CE} = 1.0 \text{ Vdc}$)		30	—	
Collector–Emitter Saturation Voltage ($I_C = 10 \text{ mAdc}$, $I_B = 1.0 \text{ mAdc}$)(3)	$V_{CE(sat)}$	—	0.2	Vdc
($I_C = 50 \text{ mAdc}$, $I_B = 5.0 \text{ mAdc}$)		—	0.3	
Base–Emitter Saturation Voltage(3) ($I_C = 10 \text{ mAdc}$, $I_B = 1.0 \text{ mAdc}$)	$V_{BE(sat)}$	0.65	0.85	Vdc
($I_C = 50 \text{ mAdc}$, $I_B = 5.0 \text{ mAdc}$)		—	0.95	

SMALL–SIGNAL CHARACTERISTICS

Current–Gain — Bandwidth Product ($I_C = 10 \text{ mAdc}$, $V_{CE} = 20 \text{ Vdc}$, $f = 100 \text{ MHz}$)	f_T	300	—	MHz
Output Capacitance ($V_{CB} = 5.0 \text{ Vdc}$, $I_E = 0$, $f = 1.0 \text{ MHz}$)	C_{obo}	—	4.0	pF
Input Capacitance ($V_{BE} = 0.5 \text{ Vdc}$, $I_C = 0$, $f = 1.0 \text{ MHz}$)	C_{ibo}	—	8.0	pF
Input Impedance ($V_{CE} = 10 \text{ Vdc}$, $I_C = 1.0 \text{ mAdc}$, $f = 1.0 \text{ kHz}$)	h_{ie}	1.0	10	pF
Voltage Feedback Ratio ($V_{CE} = 10 \text{ Vdc}$, $I_C = 1.0 \text{ mAdc}$, $f = 1.0 \text{ kHz}$)	h_{re}	0.5	8.0	$\times 10^{-4}$
Small–Signal Current Gain ($V_{CE} = 10 \text{ Vdc}$, $I_C = 1.0 \text{ mAdc}$, $f = 1.0 \text{ kHz}$)	h_{fe}	100	400	—
Output Admittance ($V_{CE} = 10 \text{ Vdc}$, $I_C = 1.0 \text{ mAdc}$, $f = 1.0 \text{ kHz}$)	h_{oe}	1.0	40	mhos
Noise Figure ($V_{CE} = 5.0 \text{ Vdc}$, $I_C = 100 \mu\text{Adc}$, $R_S = 1.0 \text{ k}\Omega$, $f = 1.0 \text{ kHz}$)	NF	—	5.0	dB

SWITCHING CHARACTERISTICS

Delay Time ($V_{CC} = 3.0 \text{ Vdc}$, $V_{BE} = -0.5 \text{ Vdc}$)	t_d	—	35	ns
Rise Time ($I_C = 10 \text{ mAdc}$, $I_{B1} = 1.0 \text{ mAdc}$)	t_r	—	35	ns
Storage Time ($V_{CC} = 3.0 \text{ Vdc}$)	t_s	—	200	ns
Fall Time ($I_C = 10 \text{ mAdc}$, $I_{B1} = I_{B2} = 10 \text{ mAdc}$)	t_f	—	50	ns

 3. Pulse Test: Pulse Width $\leq 300 \mu\text{s}$, Duty Cycle $\leq 2.0\%$.

LMBT3904LT1

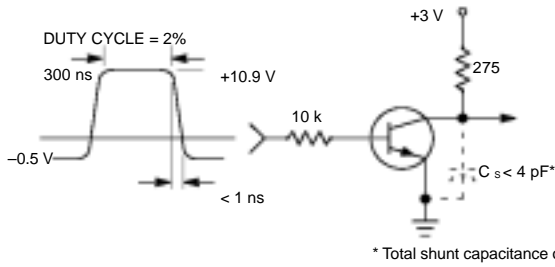

Figure 1. Delay and Rise Time Equivalent Test Circuit

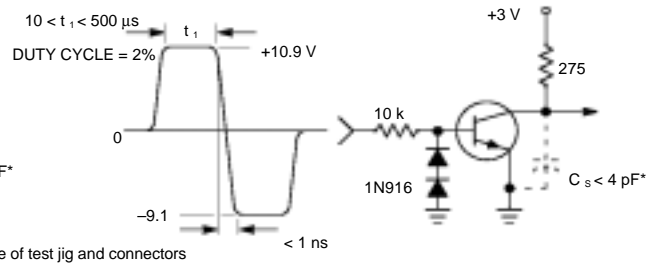

Figure 2. Storage and Fall Time Equivalent Test Circuit

TYPICAL TRANSIENT CHARACTERISTICS

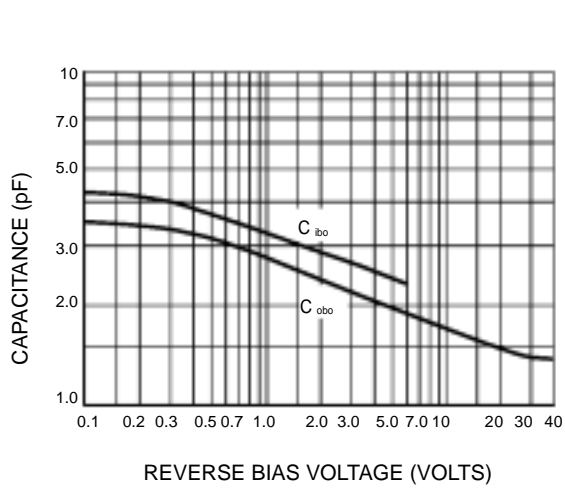

Figure 3. Capacitance

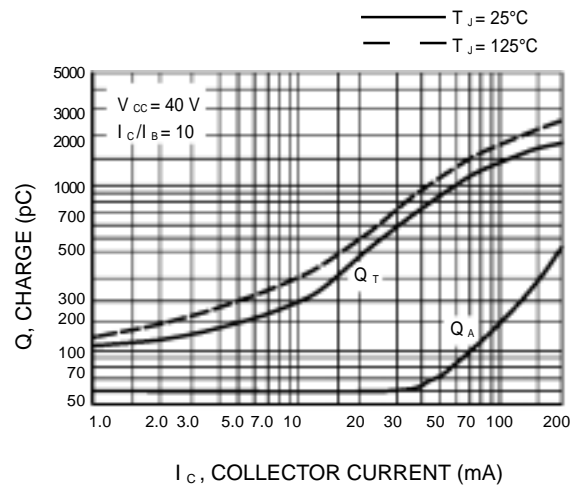

Figure 4. Charge Data

LMBT3904LT1

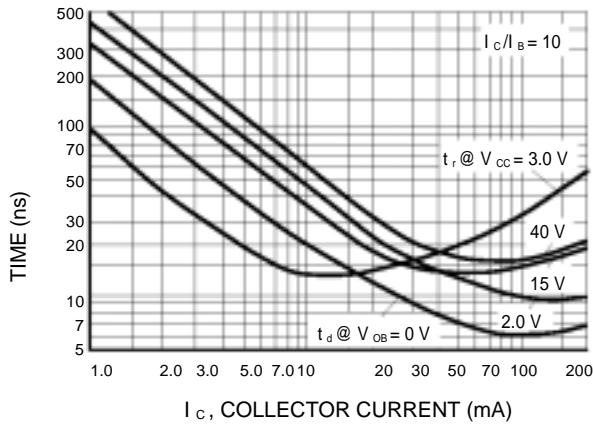

Figure 5. Turn-On Time

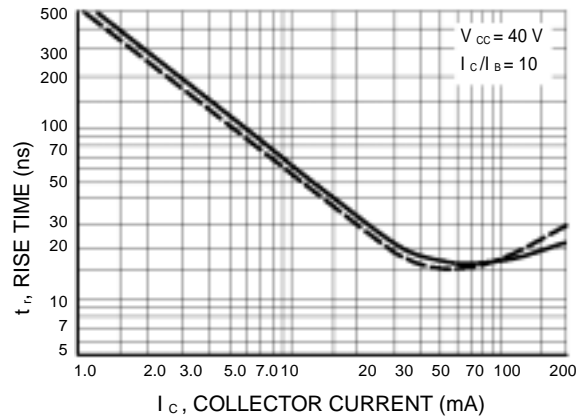

Figure 6. Rise Time

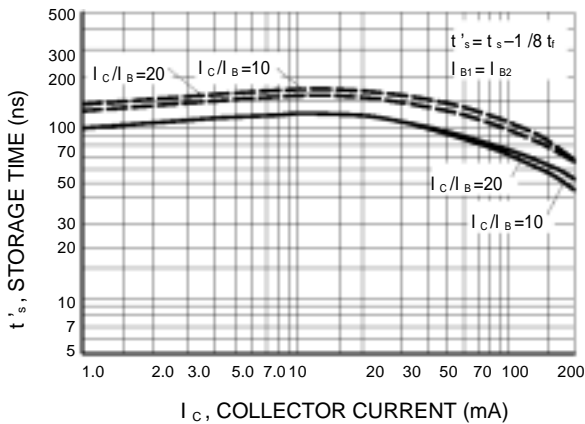

Figure 7. Storage Time

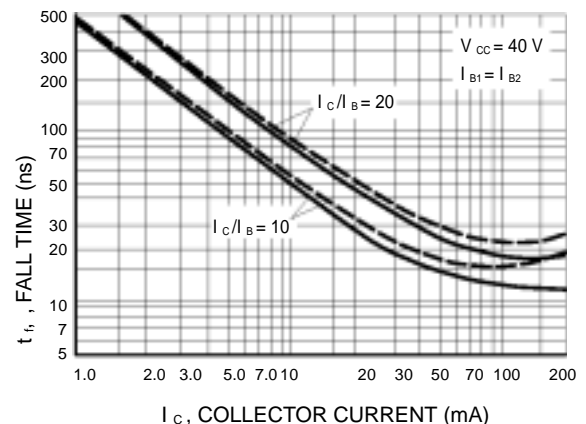

Figure 8. Fall Time

**TYPICAL AUDIO SMALL-SIGNAL CHARACTERISTICS
NOISE FIGURE VARIATIONS**

($V_{CE} = 5.0 \text{ Vdc}$, $T_A = 25^\circ\text{C}$, Bandwidth = 1.0 Hz)

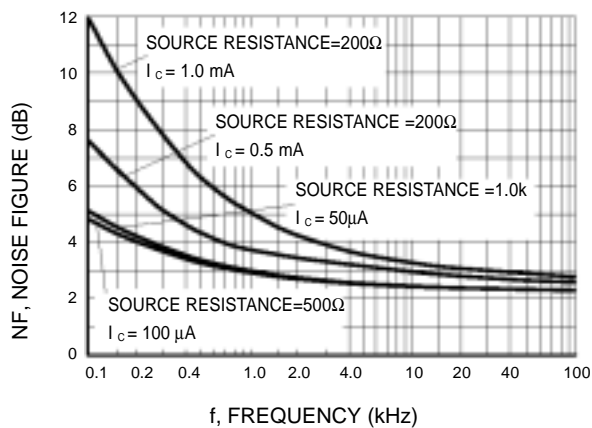

Figure 9.

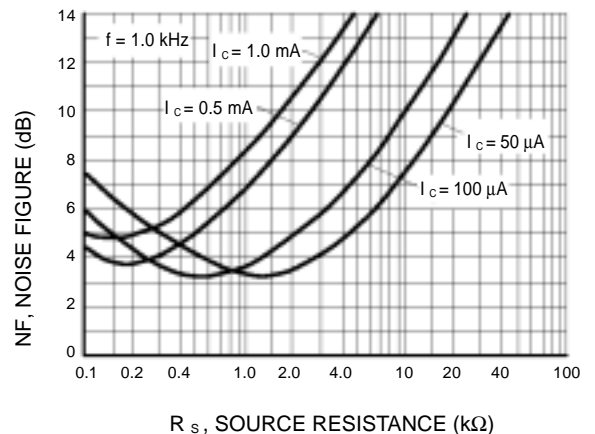

Figure 10.

h PARAMETERS

($V_{CE} = 10 \text{ Vdc}$, $f = 1.0 \text{ kHz}$, $T_A = 25^\circ\text{C}$)

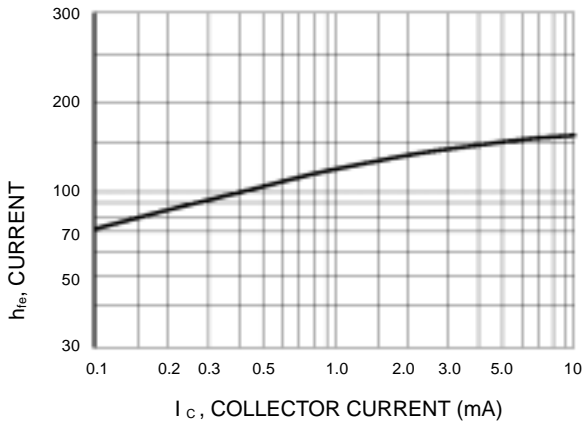

Figure 11. Current Gain

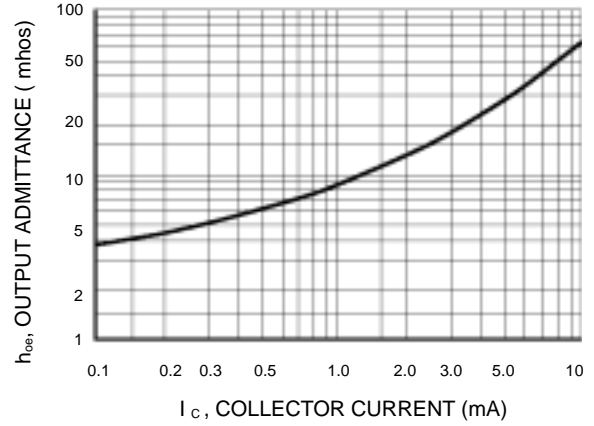

Figure 12. Output Admittance

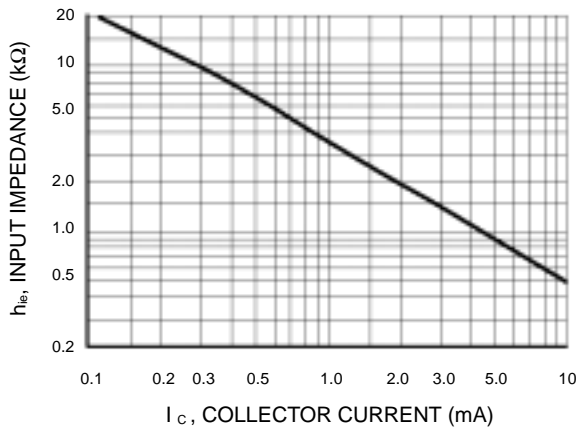

Figure 13. Input Impedance

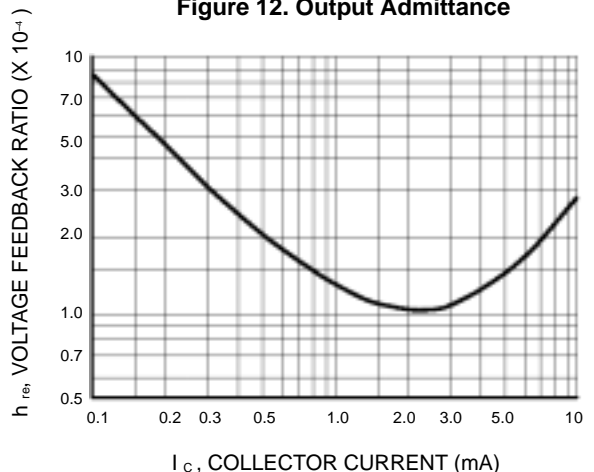

Figure 14. Voltage Feedback Ratio

TYPICAL STATIC CHARACTERISTICS

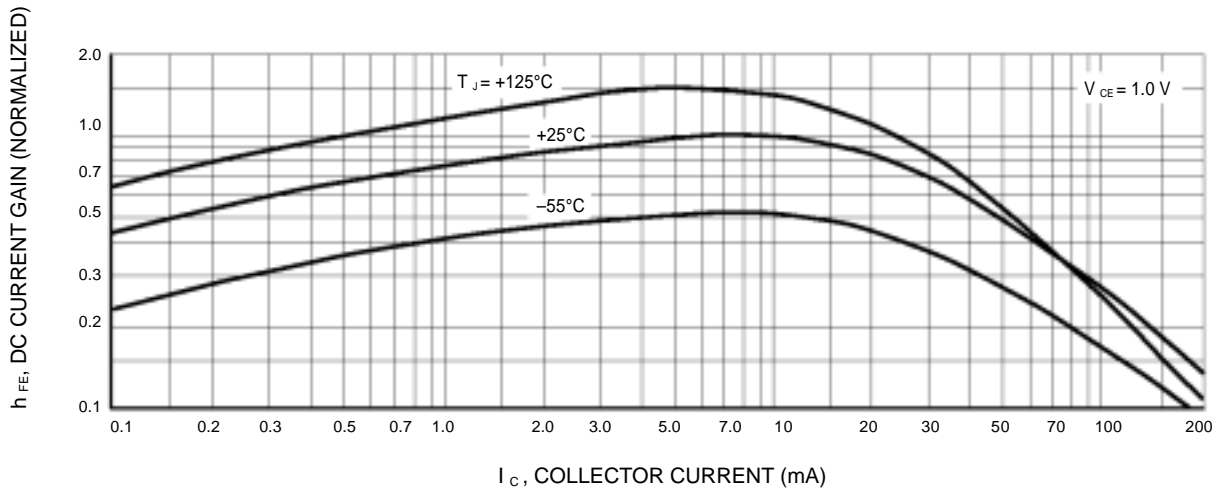

Figure 15. DC Current Gain

LMBT3904LT1

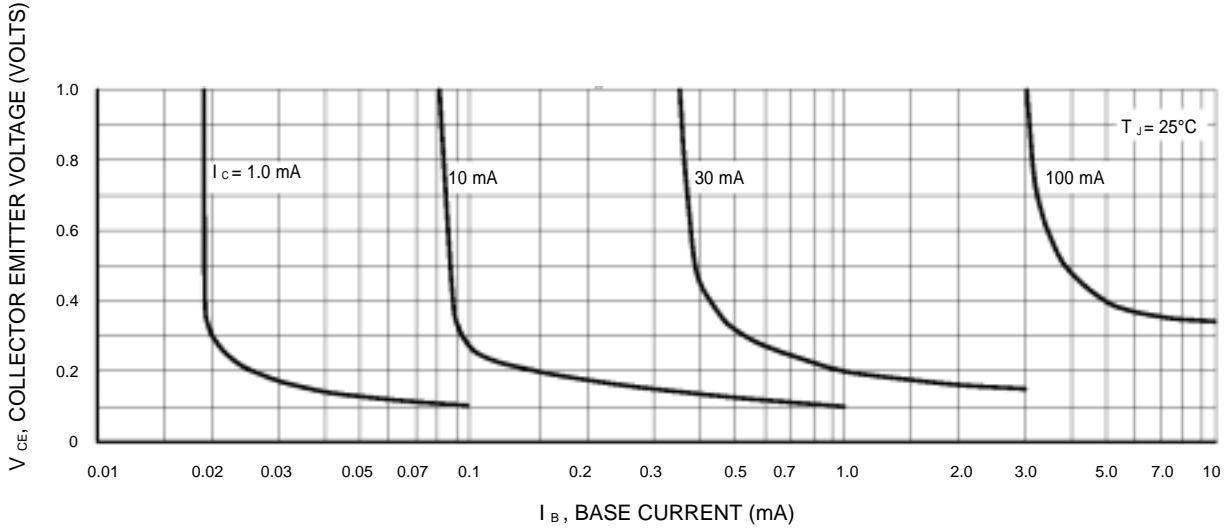

Figure 16. Collector Saturation Region

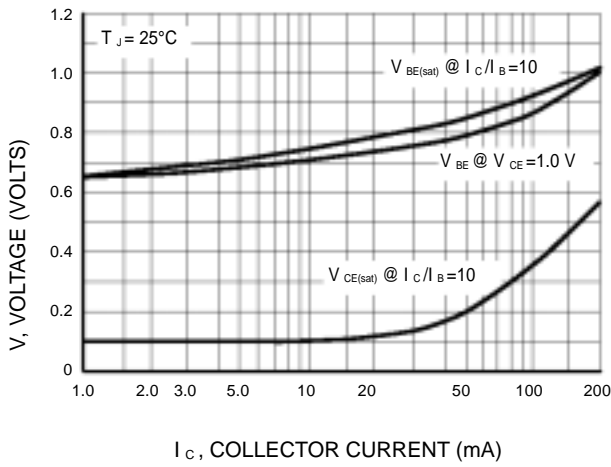

Figure 17. "ON" Voltages

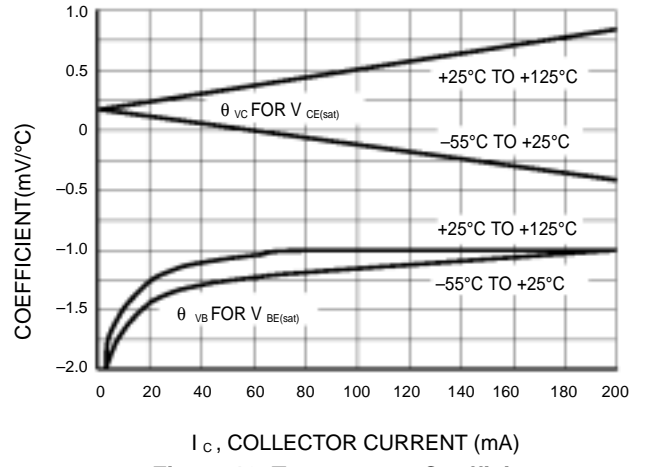
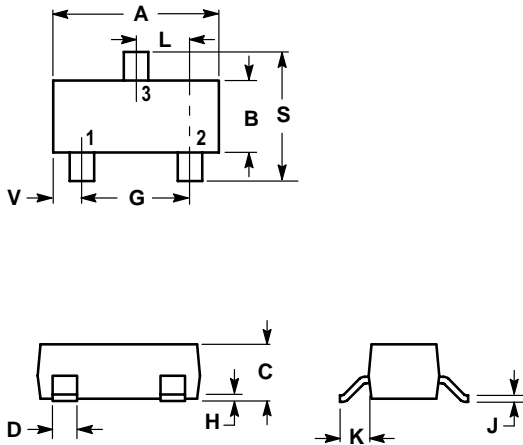

Figure 18. Temperature Coefficients

LMBT3904LT1
SOT-23

NOTES:

1. DIMENSIONING AND TOLERANCING PER ANSI Y14.5M, 1982.
2. CONTROLLING DIMENSION: INCH.

DIM	INCHES		MILLIMETERS	
	MIN	MAX	MIN	MAX
A	0.1102	0.1197	2.80	3.04
B	0.0472	0.0551	1.20	1.40
C	0.0350	0.0440	0.89	1.11
D	0.0150	0.0200	0.37	0.50
G	0.0701	0.0807	1.78	2.04
H	0.0005	0.0040	0.013	0.100
J	0.0034	0.0070	0.085	0.177
K	0.0140	0.0285	0.35	0.69
L	0.0350	0.0401	0.89	1.02
S	0.0830	0.1039	2.10	2.64
V	0.0177	0.0236	0.45	0.60

- PIN 1. BASE
 2. EMITTER
 3. COLLECTOR

