

# LT9550□ series

ø7.5mm, Cylinder Type(Flangeless),  
Colorless Transparency, High-luminosity  
Large LED lamps for Indoor Use

## Outline Dimensions

(Unit : mm)

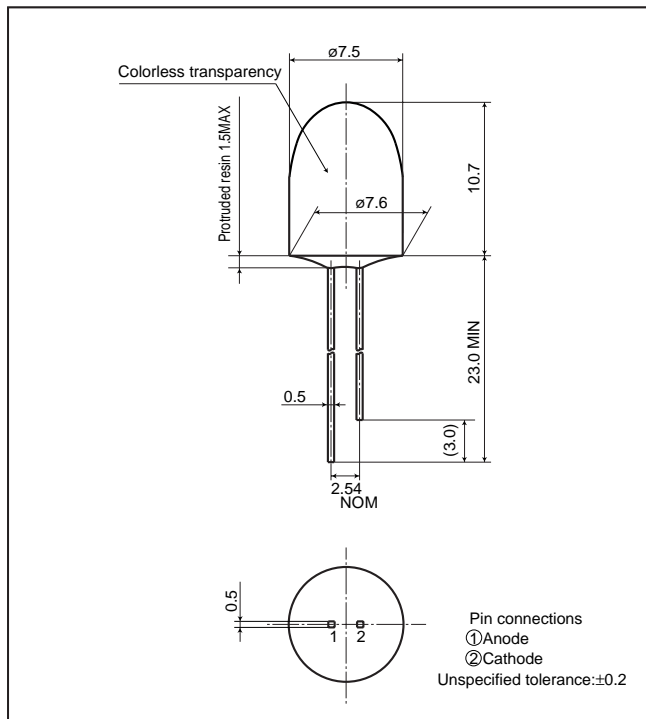

## Radiation Diagram

(Ta=25°C)

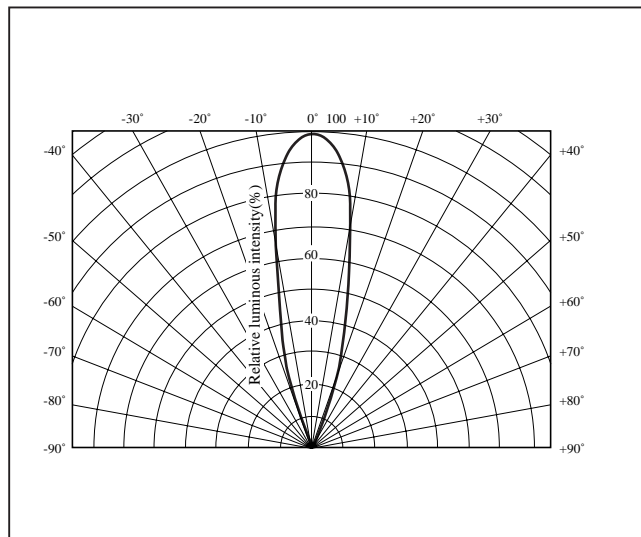

## Absolute Maximum Ratings

(Ta=25°C)

Model No.	Radiation color	Radiation material	Power dissipation P (mW)	Forward current I <sub>F</sub> (mA)	Peak forward current I <sub>FM</sub> <sup>*1</sup> (mA)	Derating factor (mA/°C)		Reverse voltage V <sub>R</sub> (V)	Operating temperature T <sub>opr</sub> (°C)	Storage temperature T <sub>stg</sub> (°C)	Soldering temperature T <sub>sol</sub> <sup>*2</sup> (°C)
						DC	Pulse				
LT9550U	Red(Super-luminosity)	GaAlAs on GaAlAs	75	30	50	0.40	0.67	4	-25 to +85	-25 to +100	260
LT9550E	Yellow-green	GaP	84	30	50	0.40	0.67	5	-25 to +85	-25 to +100	260

\*1 Duty ratio=1/10, Pulse width=0.1ms

\*2 5s or less(At the position of 1.6mm or more from the bottom face of resin package)

## Electro-optical Characteristics

(Ta=25°C)

Lens type	Model No.	Forward voltage V <sub>F</sub> (V)		Peak emission wavelength		Luminous intensity		Spectrum radiation bandwidth		Reverse current		Terminal capacitance		Page for characteristics diagrams
		TYP	MAX	λ <sub>p</sub> (nm) TYP	I <sub>F</sub> (mA)	I <sub>v</sub> (mcd) TYP	I <sub>F</sub> (mA)	Δλ(nm) TYP	I <sub>F</sub> (mA)	I <sub>R</sub> (μA) MAX	V <sub>R</sub> (V)	C <sub>t</sub> (pF) TYP	(MHz)	
Colorless transparency	LT9550U	1.85	2.5	660	20	700	20	20	20	100	3	25	1	→
	LT9550E	2.1	2.8	565	20	300	20	20	30	10	4	35	1	→

(Notice) ● In the absence of confirmation by device specification sheets, SHARP takes no responsibility for any defects that may occur in equipment using any SHARP devices shown in catalogs, data books, etc. Contact SHARP in order to obtain the latest device specification sheets before using any SHARP device.

(Internet) ● Data for sharp's optoelectronic/power device is provided for internet.(Address <http://www.sharp.co.jp/ecg/>)

# UR series

## Forward Current Derating Curve

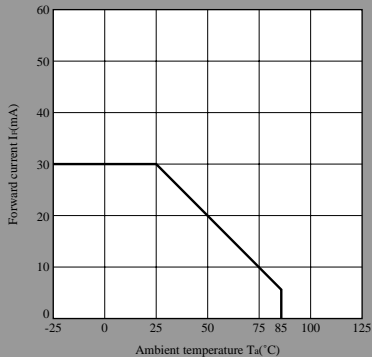

## Forward Current vs. Forward Voltage(Note)

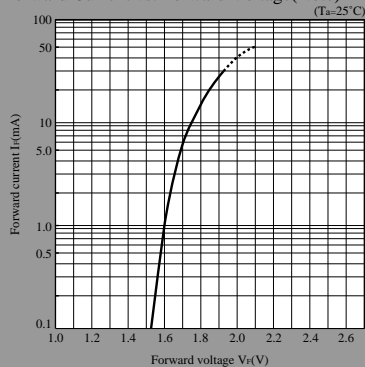

## Luminous Intensity vs. Ambient Temperature(Note)

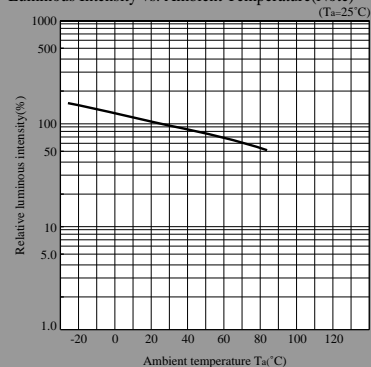

## Peak Forward Current Derating Curve

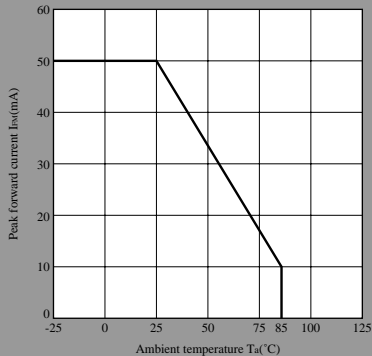

## Luminous Intensity vs. Forward Current(Note)

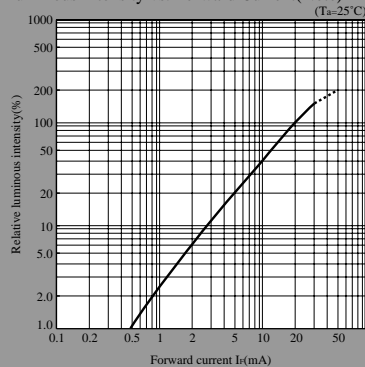

## Duty Ratio vs. Peak Forward Current

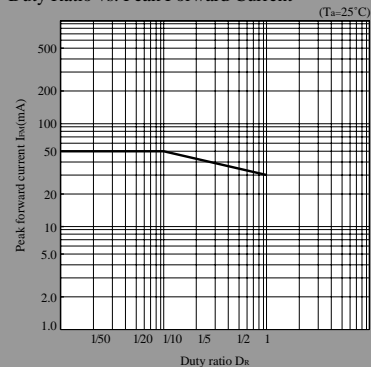

Note) Characteristics shown in diagrams are typical values. (not assurance value)

Forward Current Derating Curve

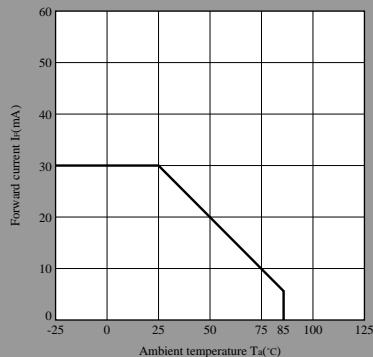

Forward Current vs. Forward Voltage(Note)

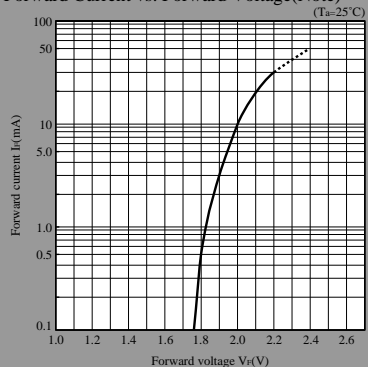

Luminous Intensity vs. Ambient Temperature(Note)

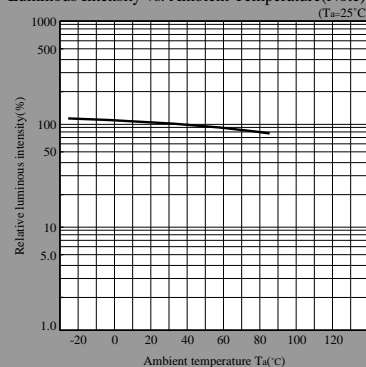

Peak Forward Current Derating Curve

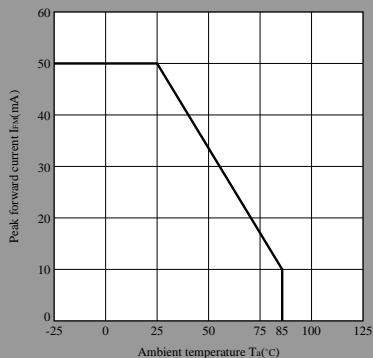

Luminous Intensity vs. Forward Current(Note)

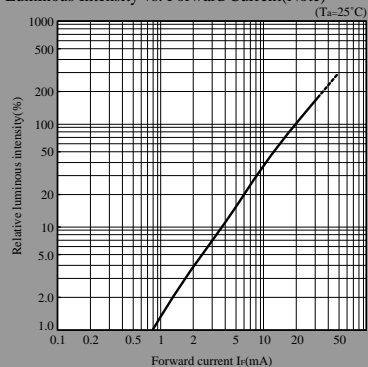

Duty Ratio vs. Peak Forward Current

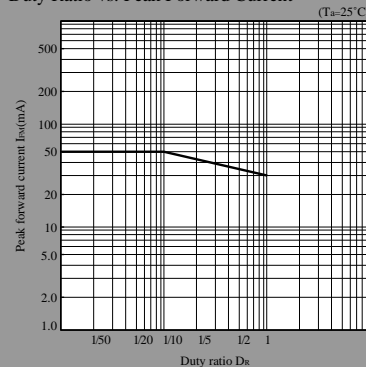

Note) Characteristics shown in diagrams are typical values. (not assurance value)