

30A, 600V, TO-247

THYRISTOR Type : 30KRC60

Construction : Center Gate Planner Type

Application : AC Power Control For General Use

Absolute Maximum Ratings

Rating	Symbol	Voltage Ratings			Unit
		30KRC60			
Repetitive Peak off-state Voltage	V_{DRM}	600			V
Non-repetitive Peak off-state Voltage	V_{DSM}	700			V
Repetitive Peak Reverse Voltage	V_{RRM}	600			V
Non-repetitive Peak Reverse Voltage	V_{RSM}	700			V

Rating	Symbol	Conditions	Max. Rated Value	Unit
Average On-State Current	$I_{O(AV)}$	180° Conduction, $T_c=80^\circ\text{C}$	30	A
RMS On-State Current	$I_{T(RMS)}$		47	A
Surge On-State Current	I_{ISM}	50Hz Half Sine Wave, 1Pulse, Non-Repetitive	600	A
ISquared t	I^2t	2 to 10ms	1800	A ² s
Peak Gate Power	P_{GM}		5	W
Average Gate Power	$P_{G(AV)}$		1	W
Peak Forward Gate Current	I_{GM}		2	A
Peak Forward Gate Voltage	V_{GM}		10	V
Peak Reverse Gate Voltage	V_{RCM}		5	V
Operating Junction Temperature Range	T_{jw}		- 40 to +125	°C
Storage Temperature Range	T_{stg}		- 40 to +150	°C
Mounting Force		Recommended Value	0.5	N•m

Electrical Characteristics

Characteristics	Symbol	Conditions	Min.	Typ.	Max.	Unit
Peak Off-State Current	I_{DM}	$V_{DM}=V_{DRM}$	$T_j=25^\circ\text{C}$		0.5	mA
			$T_j=125^\circ\text{C}$		10	
Peak Reverse Current	I_{RM}	$V_{RM}=V_{RRM}$	$T_j=25^\circ\text{C}$		0.5	mA
			$T_j=125^\circ\text{C}$		10	
Peak On-State Voltage	V_{TM}	$T_j=25^\circ\text{C}, I_{TM}=90\text{A}$			1.5	V
Gate Trigger Current	I_{GT}	$V_D=6\text{V}, I_T=1\text{A}$	$T_j=-40^\circ\text{C}$		220	mA
			$T_j=25^\circ\text{C}$		100	
			$T_j=125^\circ\text{C}$		50	
Gate Trigger Voltage	V_{GT}	$V_D=6\text{V}, I_T=1\text{A}$	$T_j=-40^\circ\text{C}$		4.0	V
			$T_j=25^\circ\text{C}$		2.5	
			$T_j=125^\circ\text{C}$		2.0	
Gate Non-Trigger Current	V_{GD}	$T_j=125^\circ\text{C}, V_D=2/3 \bullet V_{DRM}$	0.25			V
Turn-On Time	t_g	$T_j=125^\circ\text{C}, V_D=2/3 \bullet V_{DRM}$		6		μs
Delay Time	t_d			2		μs
Rise Time	t_r			4		μs
Latching Current	I_L	$T_j=25^\circ\text{C}$		100		mA
Holding Current	I_H	$T_j=25^\circ\text{C}$		50		mA
Thermal Resistance	$R_{th(j-c)}$	Junction to Case			1.0	°C/W

30KRC60 OUTLINEDRAWING (UNIT:mm)

weight:5.55gr

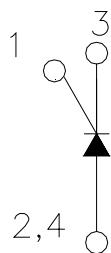
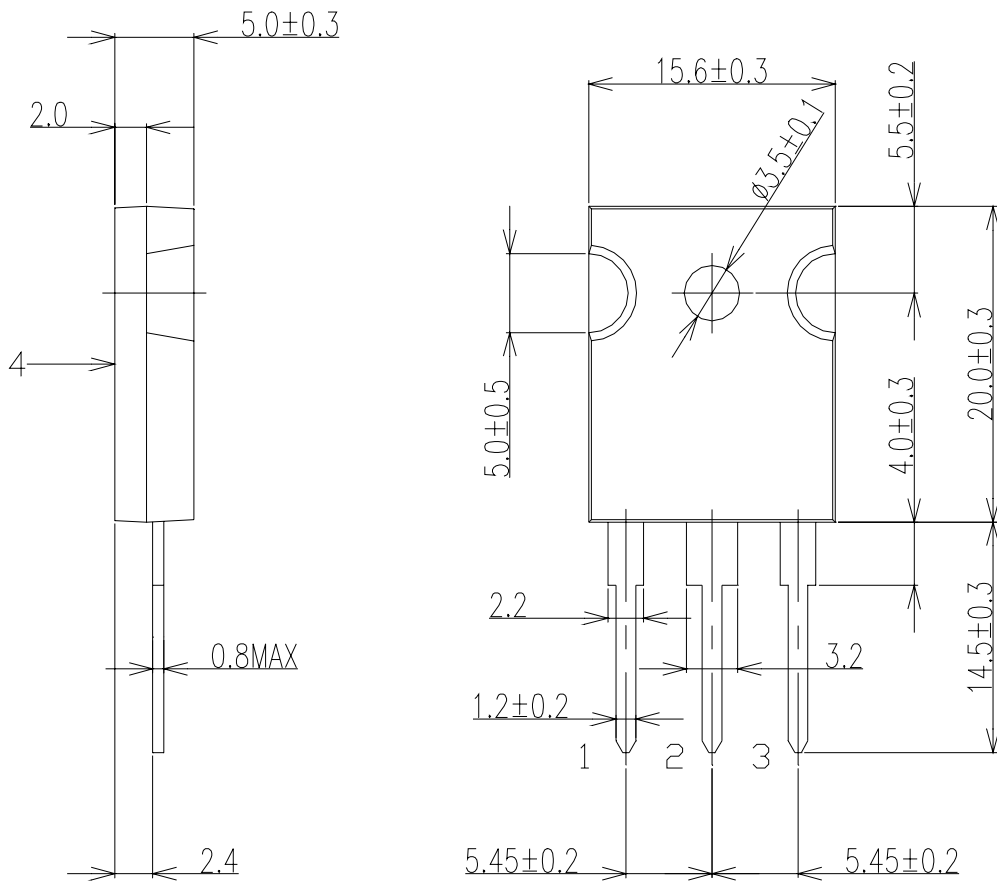

1:Gate
 2,4: Anode
 3:Cathode

オン電圧特性

ON-STATE CURRENT VS. VOLTAGE

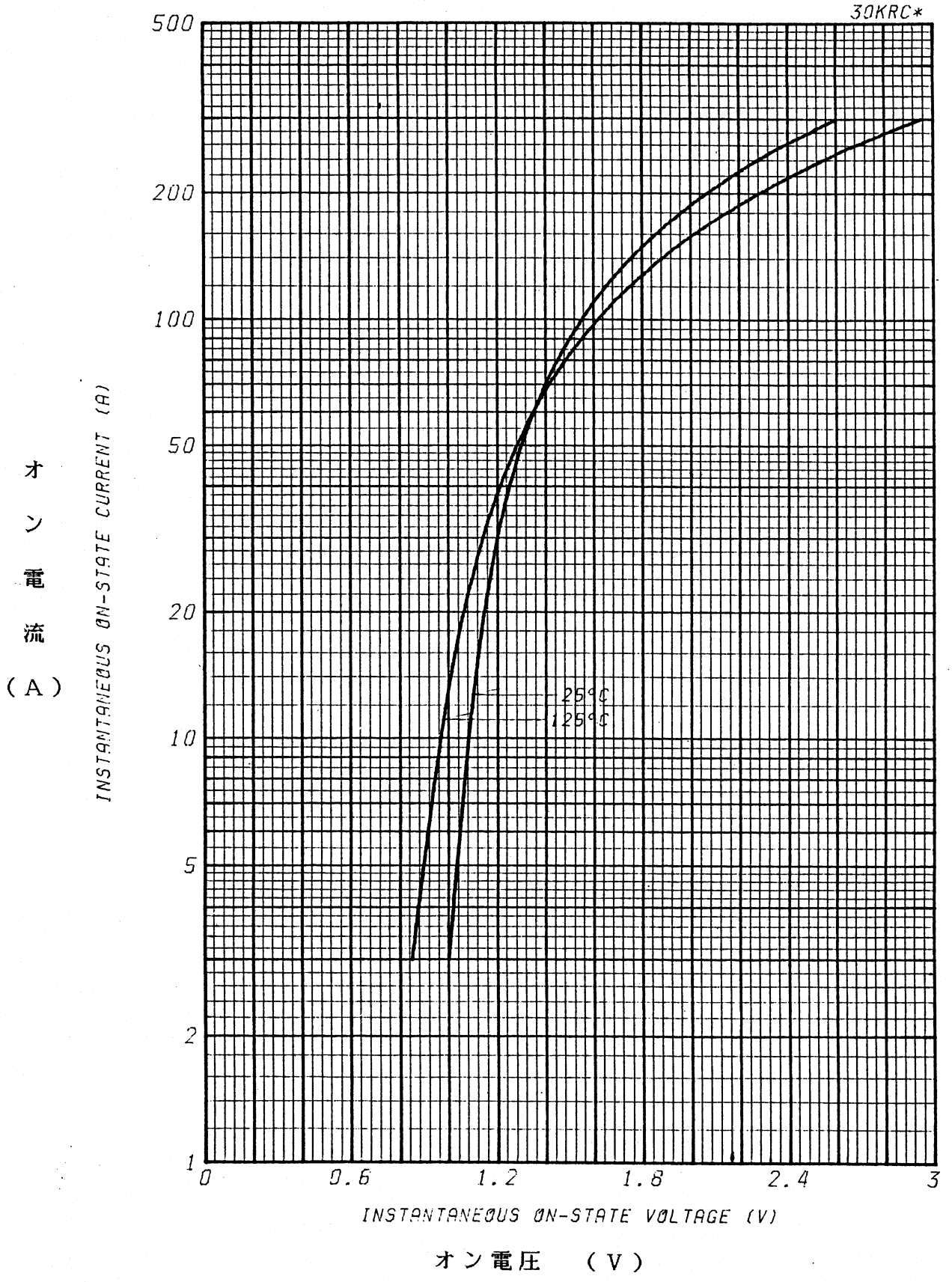

平均オン電力損失特性
(正弦波 50 Hz)

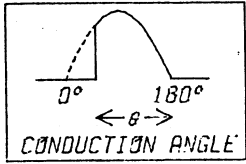

AVERAGE ON-STATE POWER DISSIPATION

for SINUSOIDAL CURRENT WAVEFORM

30KRC*

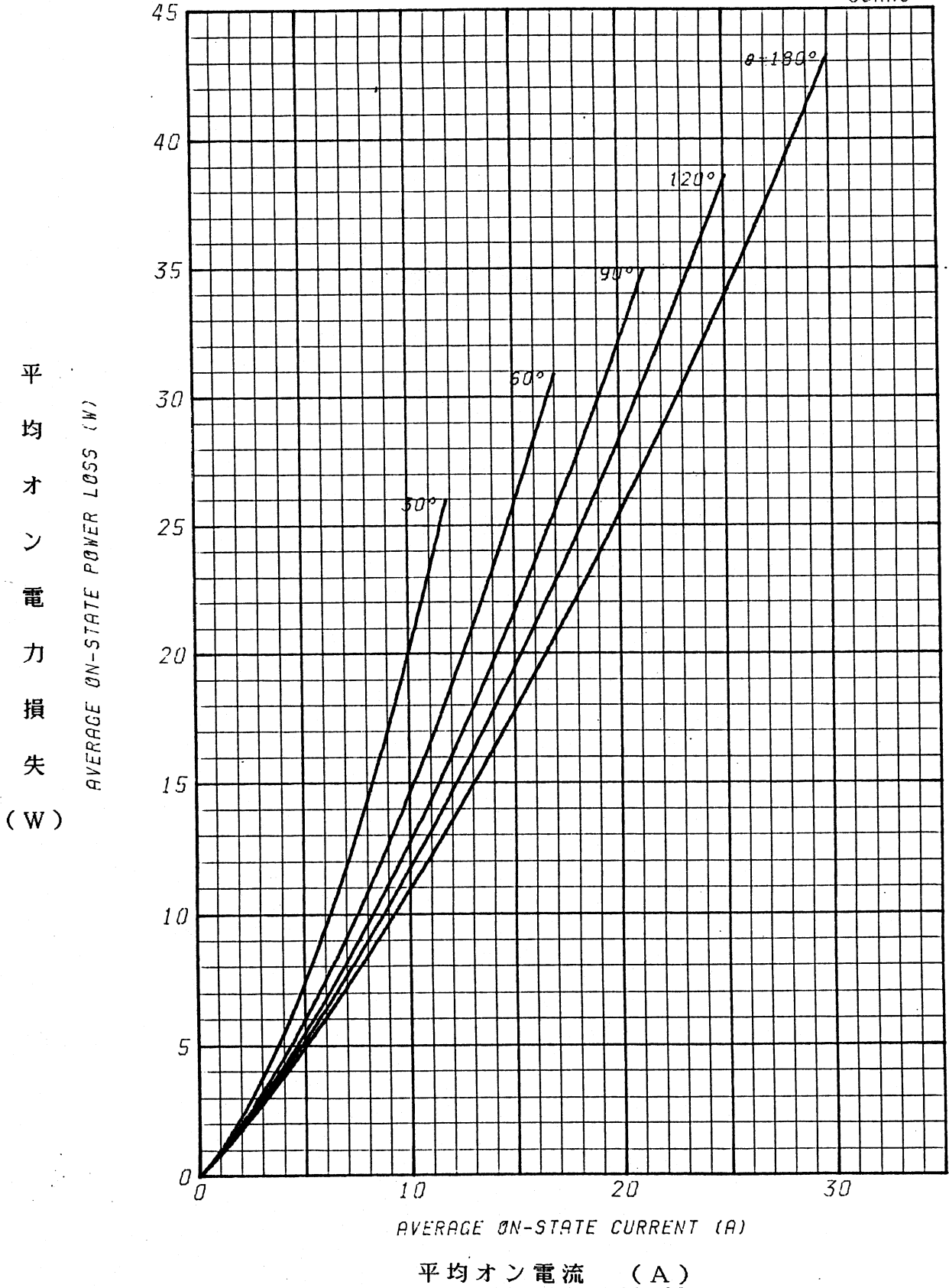

平均オン電力損失特性
(方形波 50 Hz)

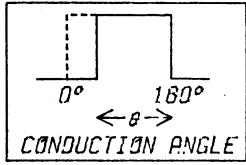

AVERAGE ON-STATE POWER DISSIPATION
for RECTANGULAR CURRENT WAVEFORM

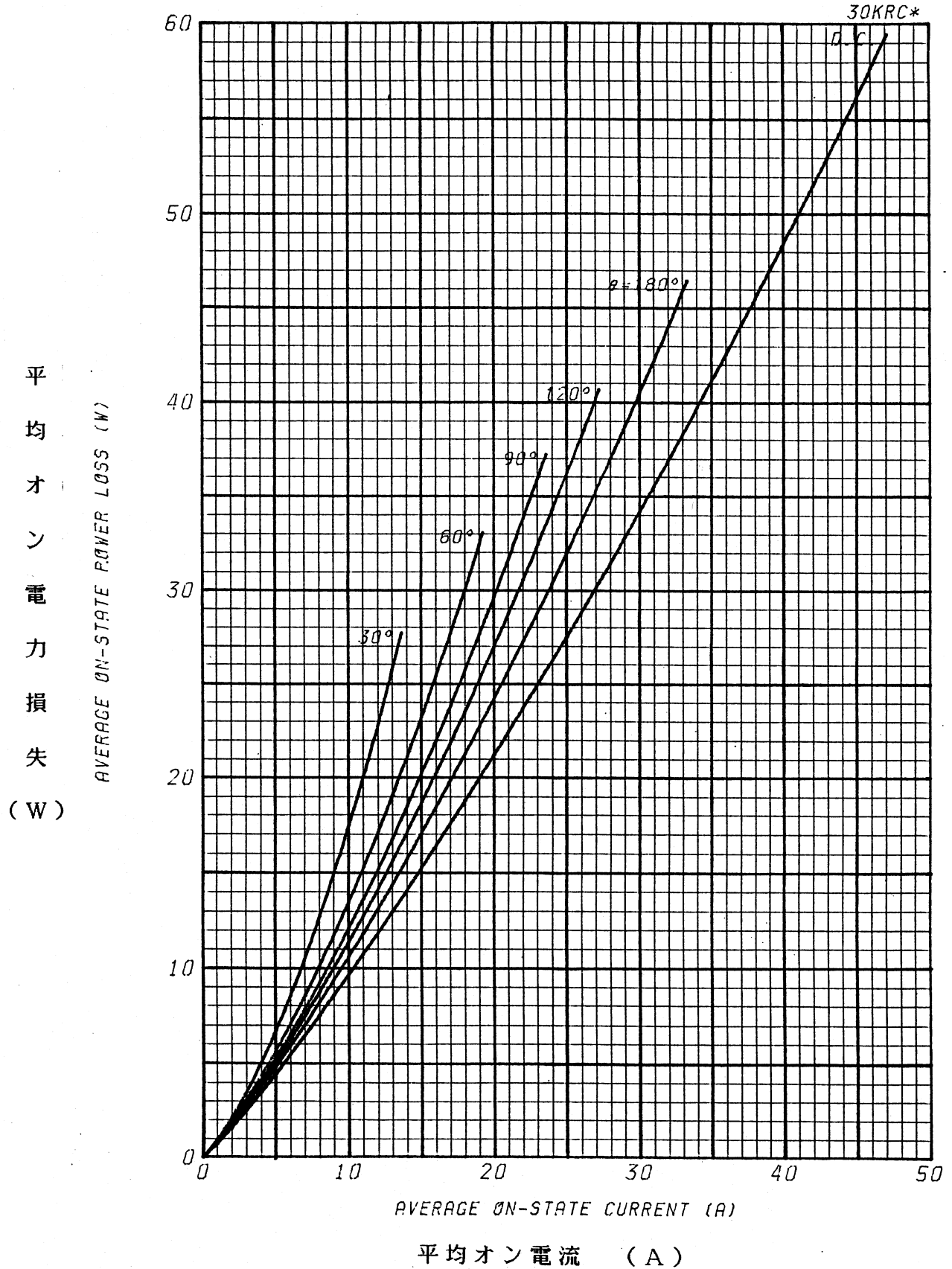

平均オン電力損失 (W)

AVERAGE ON-STATE CURRENT (A)

平均オン電流 (A)

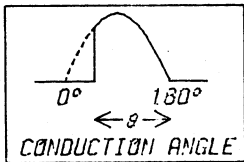

平均オン電流 - ケース温度定格
(正弦波 50 Hz)

AVERAGE ON-STATE CURRENT VS. CASE TEMPERATURE

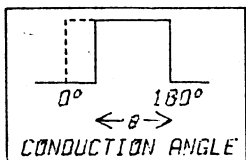
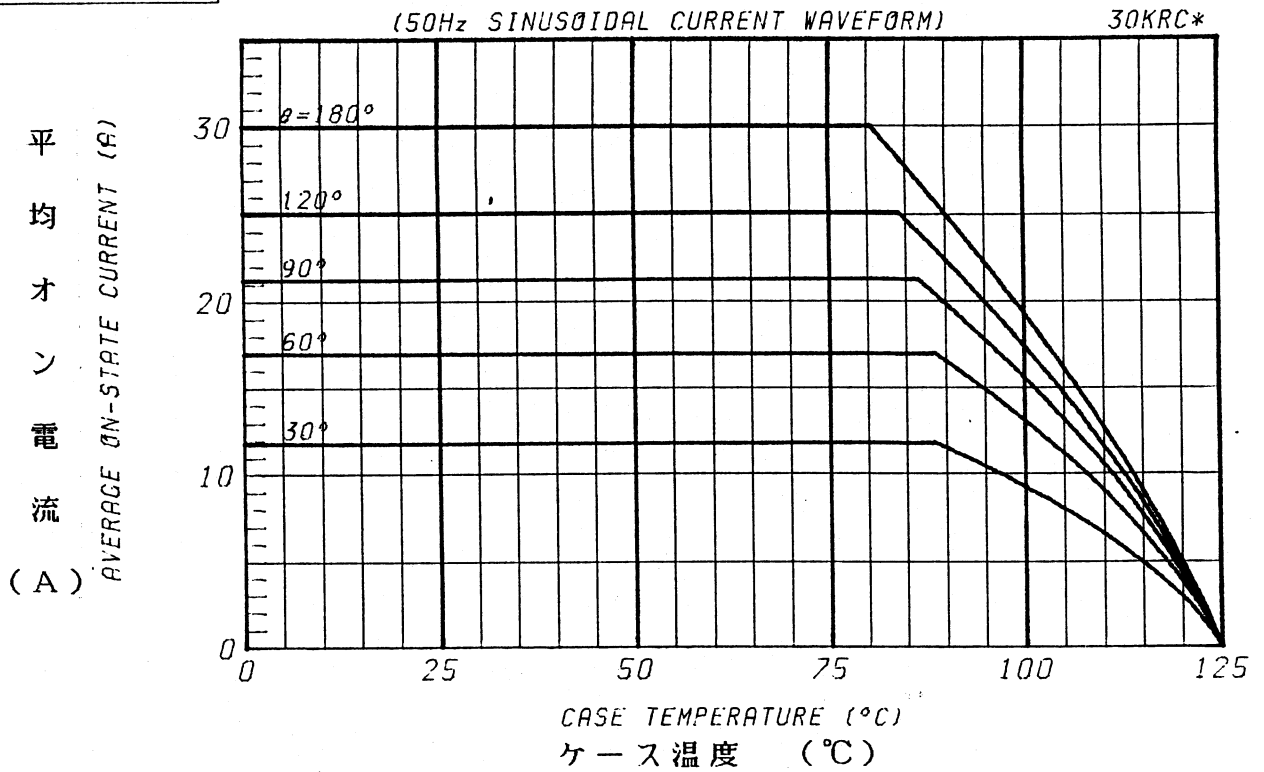

平均オン電流 - ケース温度定格
(方形波 50 Hz)

AVERAGE ON-STATE CURRENT VS. CASE TEMPERATURE

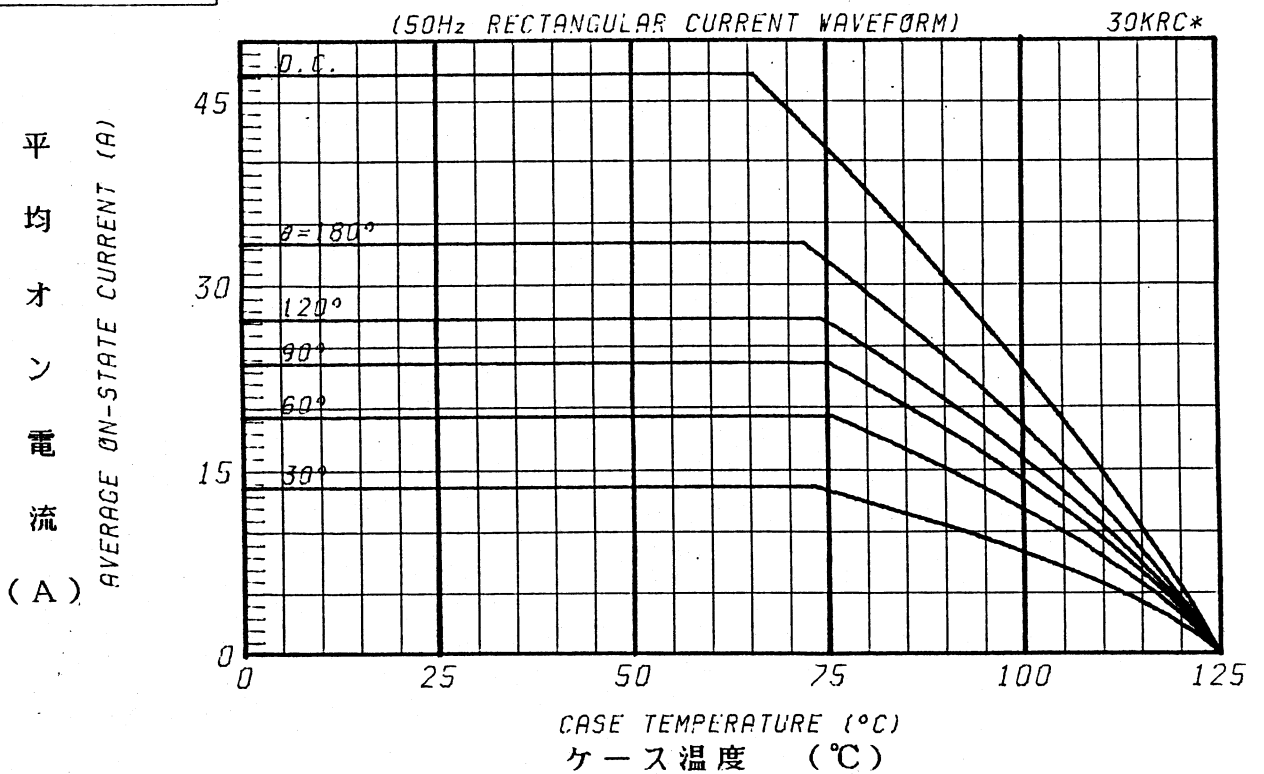

ゲート定格とゲート特性
GATE RATINGS & CHARACTERISTICS

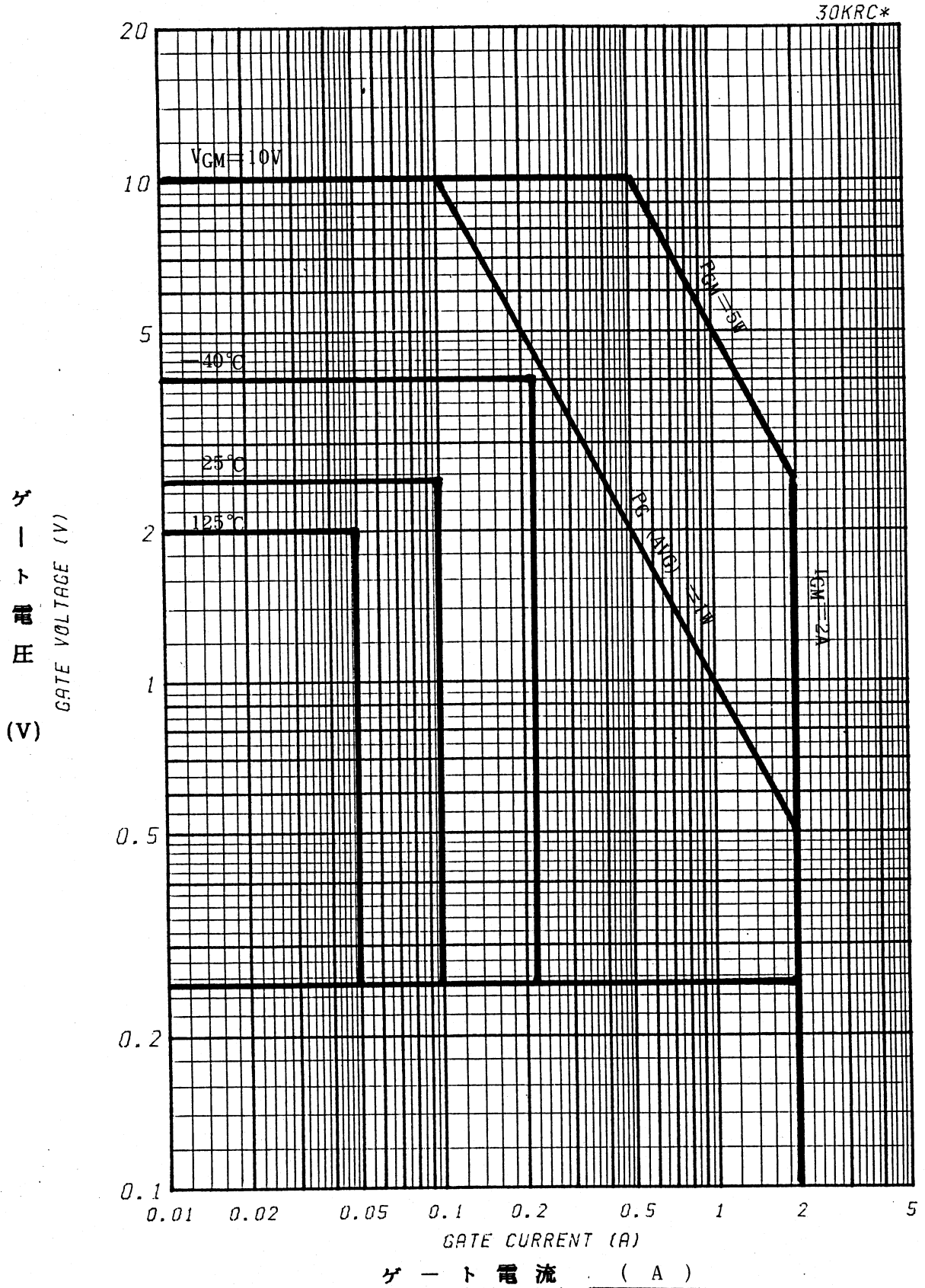

サージオン電流定格

SURGE CURRENT RATINGS

30KRC*

サージオン電流 (A)

SURGE ON-STATE CURRENT (A)

