

# DATA SHEET

## **BLU20/12** UHF power transistor

Product specification

August 1986

# UHF power transistor

# BLU20/12

### DESCRIPTION

N-P-N silicon planar epitaxial transistor primarily intended for use in mobile radio transmitters in the 470 MHz communications band.

### FEATURES

- multi-base structure and emitter-ballasting resistors for an optimum temperature profile
- gold metallization ensures excellent reliability.
- internal matching to achieve an optimum wideband capability and high power gain.

The transistor has a 6-lead flange envelope with a ceramic cap (SOT-119). All leads are isolated from the flange.

### QUICK REFERENCE DATA

Envelope	SOT-119
Mode of operation	class-B; c.w.
Collector-emitter voltage (d.c.)	$V_{CE}$ 12,5 V
Frequency	f 470 MHz
Load power	$P_L$ 20 W
Power gain	$G_P$ > 6,5 dB
Collector efficiency	$\eta_c$ > 55 %
Heatsink temperature	$T_h$ 25 °C

### PIN CONFIGURATION

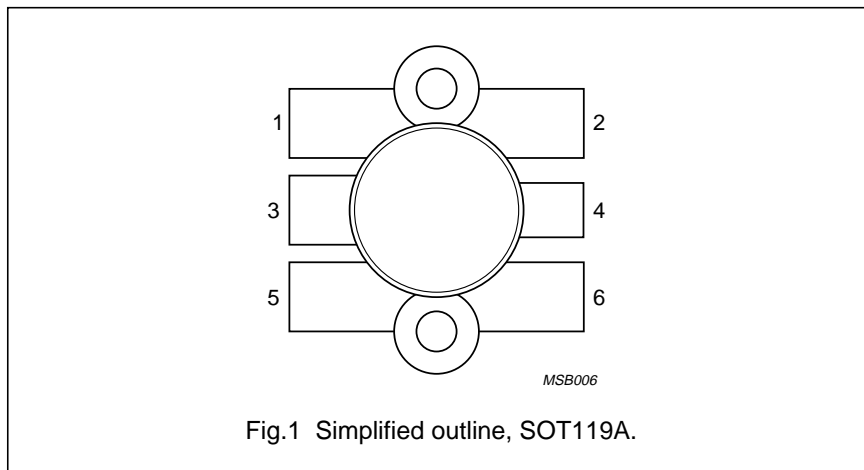

### PINNING

PIN	DESCRIPTION
1	emitter
2	emitter
3	base
4	collector
5	emitter
6	emitter

**PRODUCT SAFETY** This device incorporates beryllium oxide, the dust of which is toxic. The device is entirely safe provided that the BeO disc is not damaged.

# UHF power transistor

BLU20/12

## RATINGS

Limiting values in accordance with the Absolute Maximum System (IEC 134).

Collector-base voltage (open emitter)

peak value

$V_{CBOM}$  max. 36 V

Collector-emitter voltage (open base)

$V_{CEO}$  max. 16,5 V

Emitter-base voltage (open collector)

$V_{EBO}$  max. 4 V

Collector current

d.c. or average

$I_C$  max. 4 A

(peak value);  $f > 1$  MHz

$I_{CM}$  max. 12 A

Total power dissipation

at  $T_{mb} = 25$  °C

$P_{tot}$  (d.c.) max. 38 W

$f > 1$  MHz;  $T_{mb} = 25$  °C

$P_{tot}$  (r.f.) max. 44 W

Storage temperature

$T_{stg}$  -65 to +150 °C

Operating junction temperature

$T_j$  max. 200 °C

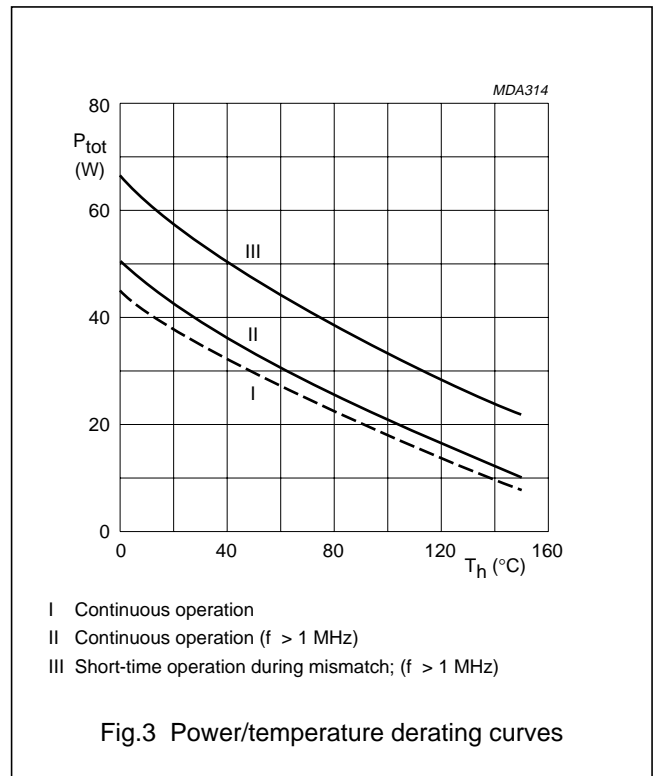
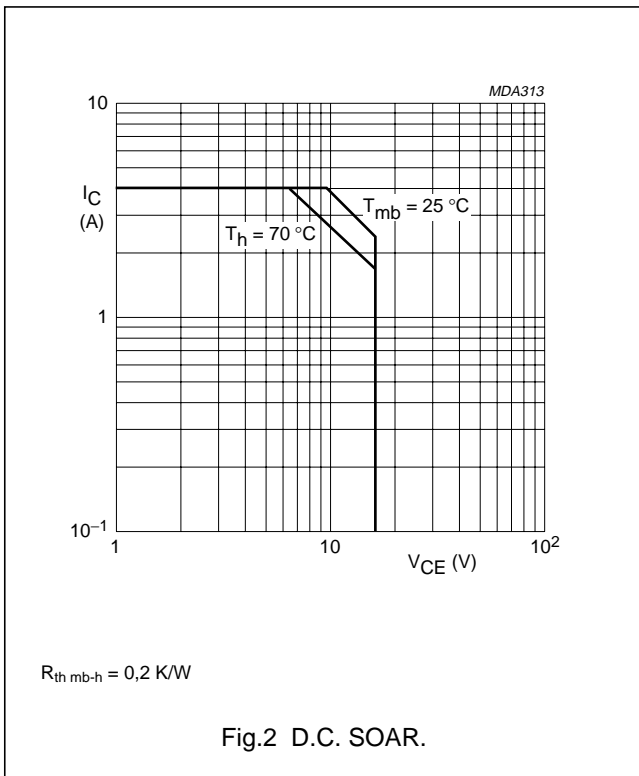

## THERMAL RESISTANCE

(dissipation = 37 W;  $T_{mb} = 25$  °C, i.e.  $T_h = 18$  °C)

From junction to mounting base

(d.c. dissipation)

$R_{th\ j-mb(d.c.)}$  max 4,6 K/W

(r.f. dissipation)

$R_{th\ j-mb(r.f.)}$  max 4,1 K/W

From mounting base to heatsink

$R_{th\ mb-h}$  max 0,2 K/W

UHF power transistor

BLU20/12

**CHARACTERISTICS**

$T_j = 25\text{ }^\circ\text{C}$  unless otherwise specified

Collector-base breakdown voltage

$I_C = 25\text{ mA}$ ; open emitter

$V_{(BR)CBO} > 36\text{ V}$

Collector-emitter breakdown voltage

$I_C = 50\text{ mA}$ ; open base

$V_{(BR)CEO} > 16,5\text{ V}$

Emitter-base breakdown voltage

$I_E = 5\text{ mA}$ ; open collector

$V_{(BR)EBO} > 4\text{ V}$

Collector cut-off current

$V_{BE} = 0$ ;  $V_{CE} = 20\text{ V}$

$I_{CES} < 12,5\text{ mA}$

Second breakdown energy

$L = 25\text{ mH}$ ;  $f = 50\text{ Hz}$ ;  $R_{BE} = 10\text{ }\Omega$

$E_{SBR} > 5,3\text{ mJ}$

D.C. current gain

$I_C = 2,7\text{ A}$ ;  $V_{CE} = 10\text{ V}$

$h_{FE} > 15$   
typ. 60

Collector capacitance at  $f = 1\text{ MHz}$

$I_E = I_e = 0$ ;  $V_{CB} = 12,5\text{ V}$

$C_C$  typ. 53 pF

Feed-back capacitance at  $f = 1\text{ MHz}$

$I_C = 0$ ;  $V_{CE} = 12,5\text{ V}$

$C_{re}$  typ. 33 pF

Collector-flange capacitance

$C_{cf}$  typ. 3 pF

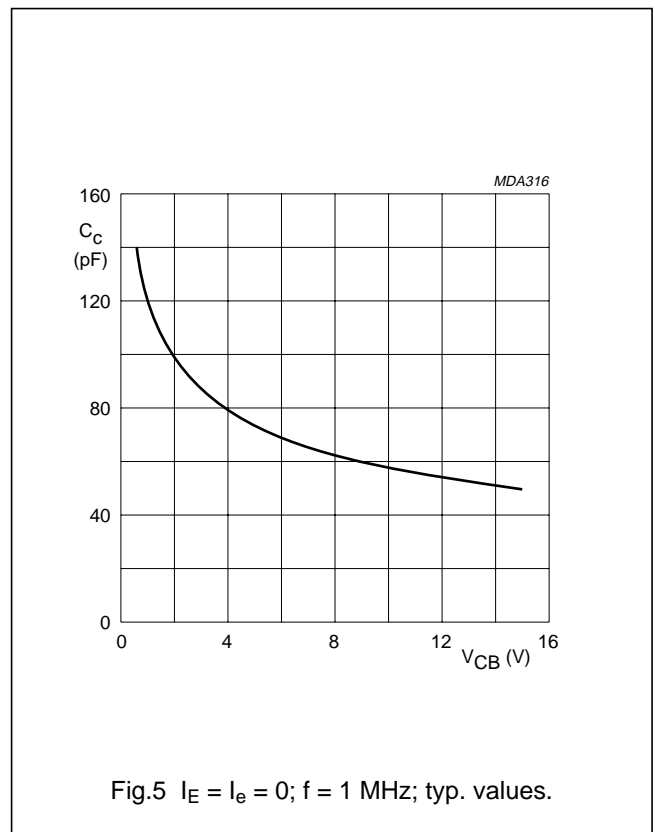
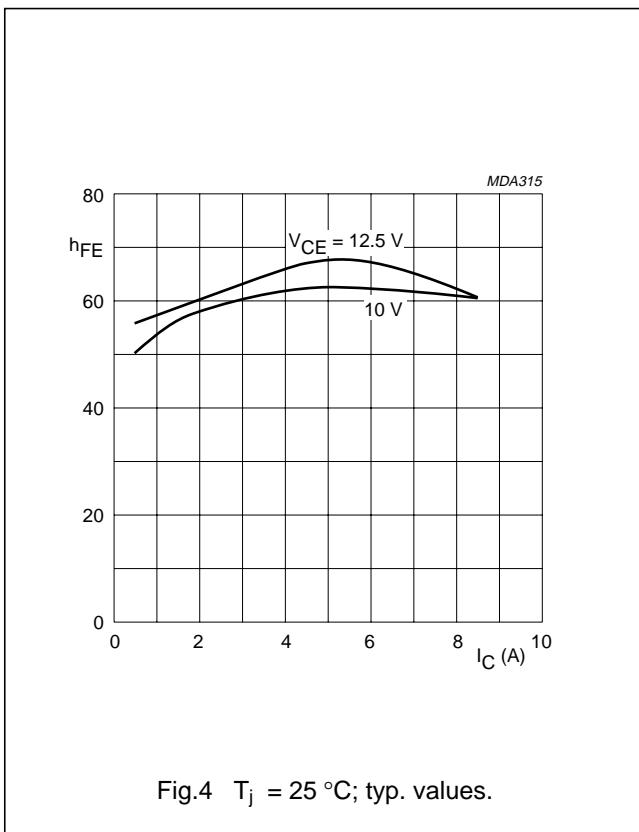

UHF power transistor

BLU20/12

APPLICATION INFORMATION

Mode of operation

in narrow band test circuit;  
class-B; c.w.

Collector-emitter voltage (d.c.)

$V_{CE}$  12,5 V

Frequency

$f$  470 MHz

Load power

$P_L$  20 W

Power gain

$G_p$  > 6,5 dB  
typ. 7,8 dB

Collector efficiency

$\eta_c$  > 55 %  
typ. 64 %

Heatsink temperature

$T_h$  25 °C

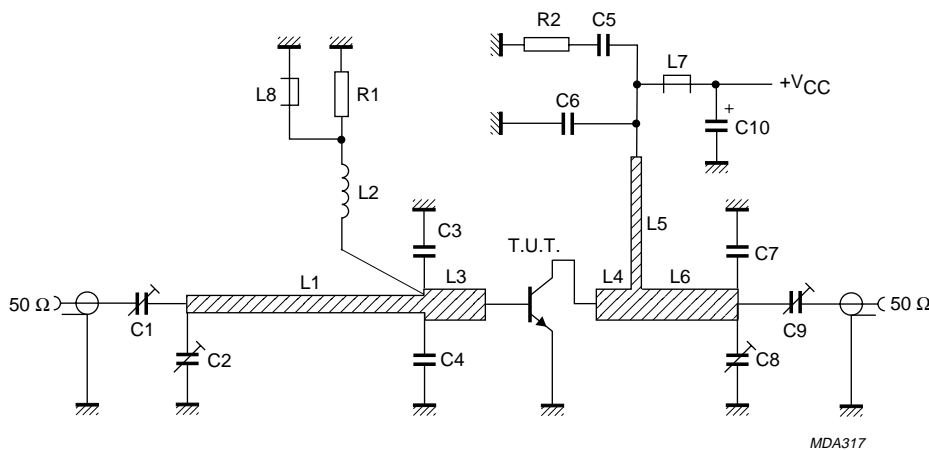

Fig.6 Class-B test circuit at  $f = 470$  MHz.

---

**UHF power transistor****BLU20/12**

---

**List of components:**

C1 = C9 = 1,8 to 10 pF film dielectric trimmer (cat. no. 2222 809 05002)

C2 = 2 to 9 pF film dielectric trimmer (cat.no. 2222 809 09002)

C3 = C4 = 8,2 pF multilayer ceramic chip capacitor (100A type) <sup>(1)</sup>

C5 = 100 nF polyester film capacitor

C6 = 120 pF multilayer ceramic chip capacitor

C7 = 8,2 pF multilayer ceramic chip capacitor (100B type) <sup>(1)</sup>

C8 = 2 to 18 pF film dielectric trimmer (cat.no. 2222 809 09003)

C10 = 2,2  $\mu$ F electrolytic capacitor

L1 = 50  $\Omega$  stripline (43,5 mm  $\times$  4,0 mm)

L2 = 100 nH; 5 turns closely wound enamelled Cu-wire (0,5 mm); int. diam. 4 mm; leads 2  $\times$  5 mm

L3 = 37,6  $\Omega$  stripline (8,0 mm  $\times$  6,0 mm)

L4 = 37,6  $\Omega$  stripline (9,0 mm  $\times$  6,0 mm)

L5 = 74,4  $\Omega$  stripline (22,5 mm  $\times$  2,0 mm)

L6 = 37,6  $\Omega$  stripline (18,0 mm  $\times$  6,0 mm)

L7 = L8 = Ferroxcube wideband h.f. choke, grade 3B (cat.no. 4312 020 36642)

R1 = 1  $\Omega \pm 5\%$ ; 0,4 W metal film resistor (MR25 type)

R2 = 10  $\Omega \pm 5\%$ ; 0,4 W metal film resistor (MR25 type)

L1, L3, L4, L5 and L6 are striplines on a double Cu-clad printed circuit board with P.T.F.E. fibre-glass dielectric ( $\epsilon_r = 2,74$ ); thickness 1/16 inch.

**Note**

1. American Technical Ceramics capacitor or capacitor of same quality.

UHF power transistor

BLU20/12

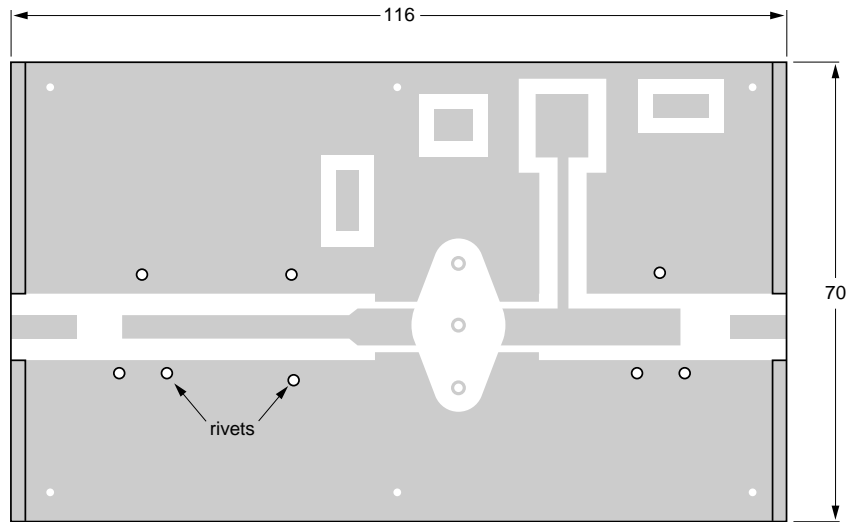
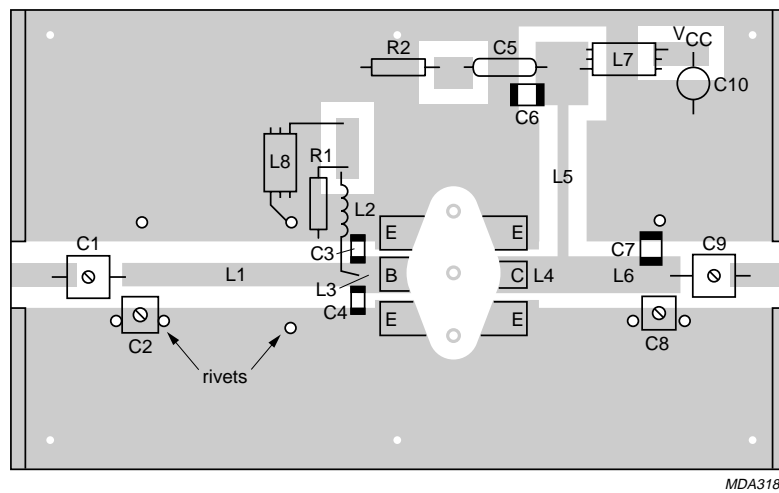

Fig.7 P.C. board for 470 MHz, class-B test circuit.



MDA318

The circuit and the components are on one side of the P.T.F.E. fibre-glass board; the other side is unetched copper serving as groundplane. Earth connections are made by hollow rivets and also by copper straps under the emitters and around the board to provide a direct contact between the copper on the component side and the ground plane.

Dimensions in mm.

Fig.8 Component lay-out of 470 MHz, class-B test circuit.

UHF power transistor

BLU20/12

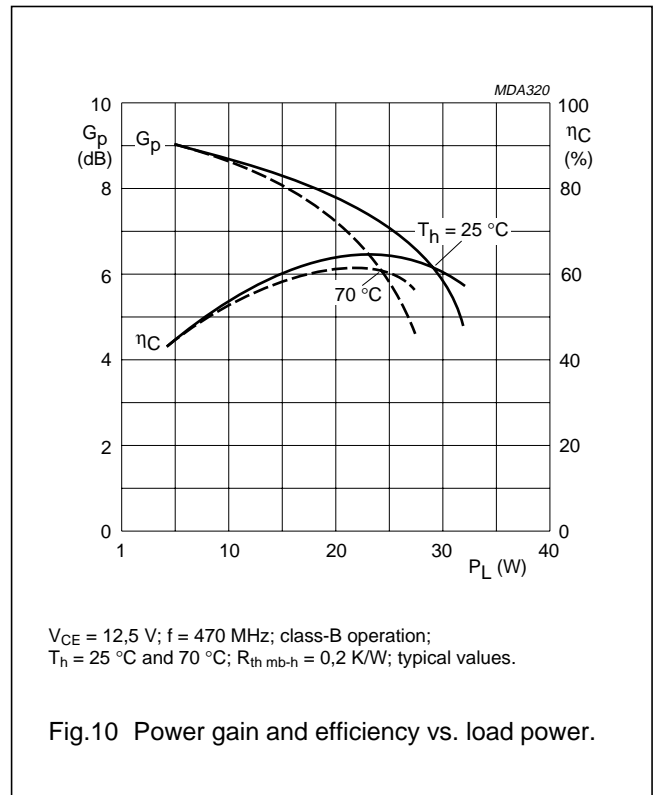
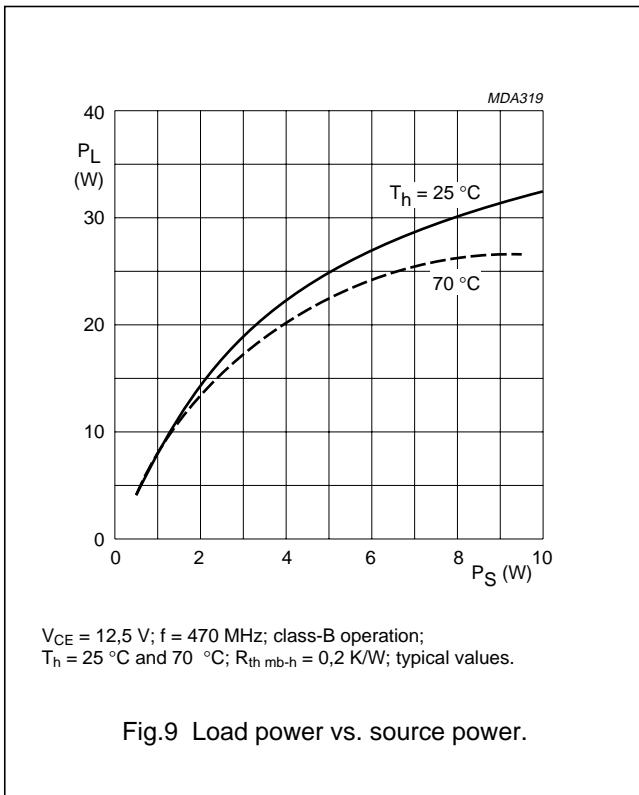

**RUGGEDNESS**

The device is capable of withstanding a full load mismatch (VSWR = 50; all phases) up to 25 W under the following conditions:

$V_{CE} = 15,5\text{ V}; f = 470\text{ MHz}; T_h = 25\text{ }^\circ\text{C}; R_{th\text{ mb-h}} = 0,2\text{ K/W}.$



UHF power transistor

BLU20/12

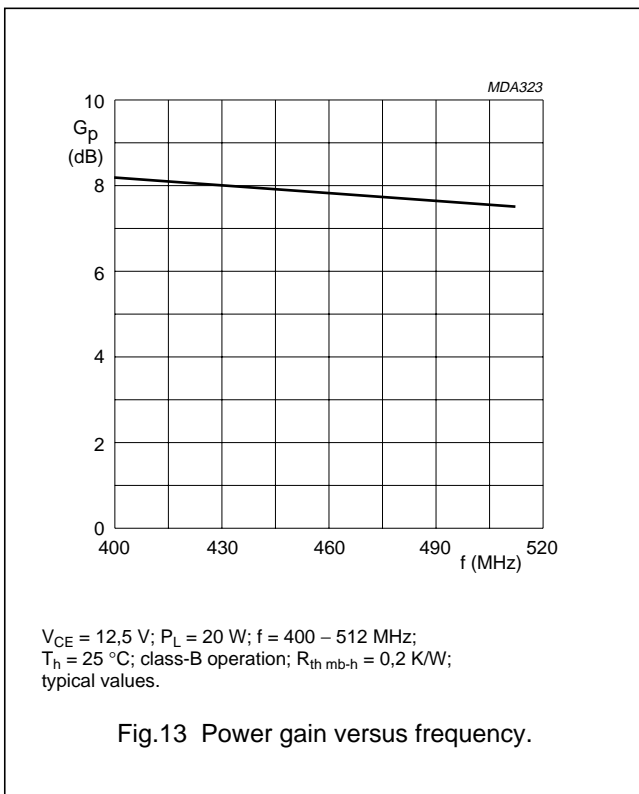
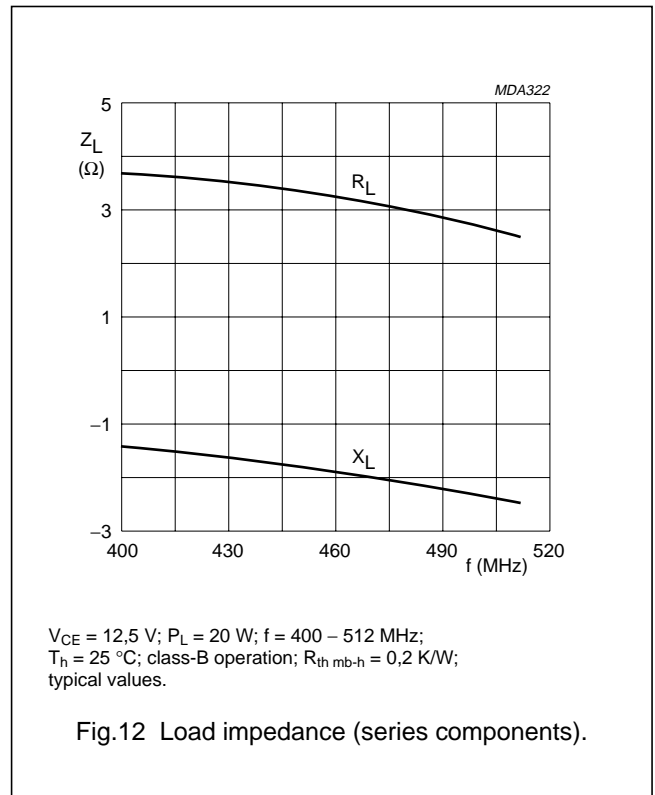
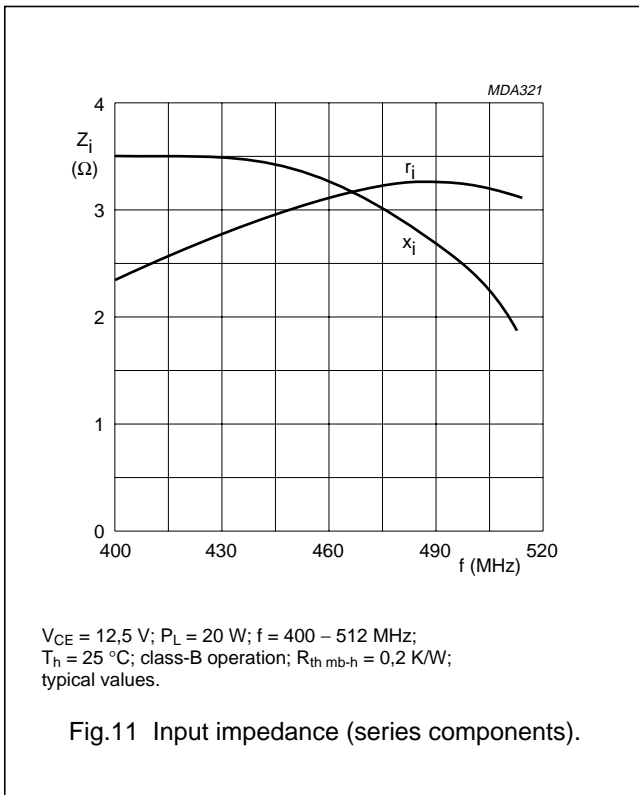

# UHF power transistor

BLU20/12

## PACKAGE OUTLINE

Flanged ceramic package; 2 mounting holes; 6 leads

SOT119A

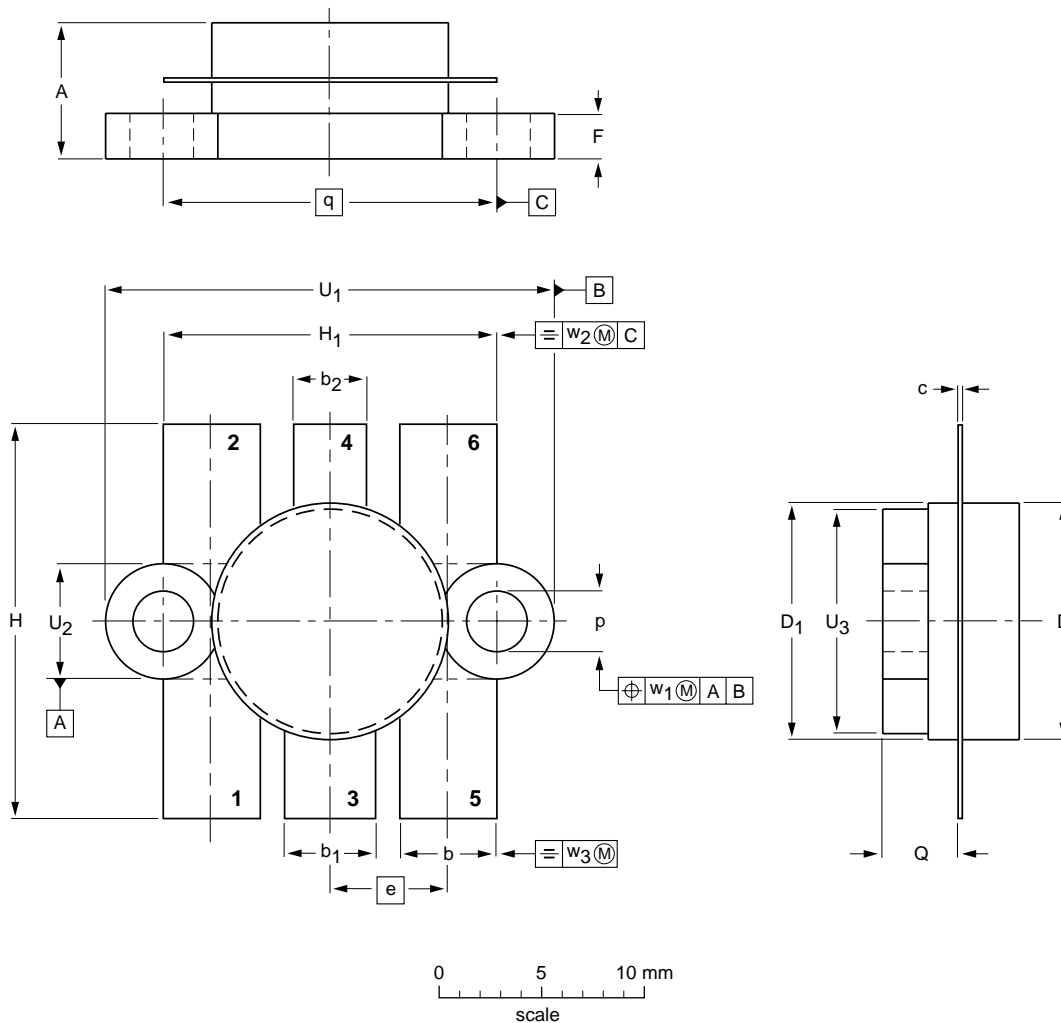

DIMENSIONS (millimetre dimensions are derived from the original inch dimensions)

UNIT	A	b	b <sub>1</sub>	b <sub>2</sub>	c	D	D <sub>1</sub>	e	F	H	H <sub>1</sub>	p	Q	q	U <sub>1</sub>	U <sub>2</sub>	U <sub>3</sub>	w <sub>1</sub>	w <sub>2</sub>	w <sub>3</sub>
mm	7.39 6.32	5.59 5.33	5.34 5.08	4.07 3.81	0.18 0.07	12.86 12.59	12.83 12.57	6.48	2.54 2.28	22.10 21.08	18.55 18.28	3.31 2.97	4.58 3.98	18.42	25.23 23.95	6.48 6.07	12.76 12.06	0.51	1.02	0.26
inches	0.291 0.249	0.220 0.210	0.210 0.200	0.160 0.150	0.007 0.003	0.505 0.496	0.505 0.495	0.255	0.100 0.090	0.870 0.830	0.730 0.720	0.130 0.117	0.180 0.157	0.725	0.993 0.943	0.255 0.239	0.502 0.475	0.02	0.04	0.01

OUTLINE VERSION	REFERENCES				EUROPEAN PROJECTION	ISSUE DATE
	IEC	JEDEC	EIAJ			
SOT119A						97-06-28

## UHF power transistor

BLU20/12

**DEFINITIONS**

<b>Data Sheet Status</b>	
Objective specification	This data sheet contains target or goal specifications for product development.
Preliminary specification	This data sheet contains preliminary data; supplementary data may be published later.
Product specification	This data sheet contains final product specifications.
<b>Limiting values</b>	
Limiting values given are in accordance with the Absolute Maximum Rating System (IEC 134). Stress above one or more of the limiting values may cause permanent damage to the device. These are stress ratings only and operation of the device at these or at any other conditions above those given in the Characteristics sections of the specification is not implied. Exposure to limiting values for extended periods may affect device reliability.	
<b>Application information</b>	
Where application information is given, it is advisory and does not form part of the specification.	

**LIFE SUPPORT APPLICATIONS**

These products are not designed for use in life support appliances, devices, or systems where malfunction of these products can reasonably be expected to result in personal injury. Philips customers using or selling these products for use in such applications do so at their own risk and agree to fully indemnify Philips for any damages resulting from such improper use or sale.