



# **DATA SHEET**

---

O K I A S I C P R O D U C T S

## **MG113P/114P/115P/73P/74P/75P 0.25 $\mu$ m Sea of Gates and Customer Structured Arrays**

---

**November 1999**



**Oki Semiconductor**



# Oki Semiconductor

## MG113P/114P/115P/73P/74P/75P

### 0.25 $\mu$ m Sea of Gates and Customer Structured Arrays

#### DESCRIPTION

Oki's 0.25 $\mu$ m Application-Specific Integrated Circuit (ASIC) products are available in both Sea Of Gates (SOG) and Customer Structured Array (CSA) architectures. Both the SOG-based MG115P series and the CSA-based MG75P series use a five-layer metal process on 0.25 $\mu$ m drawn (0.18 $\mu$ m L-effective) CMOS technology. The SOG MG113P/114P series uses the same SOG base-array architecture as the MG115P series, but offers four and three metal layers, respectively. The MG73P/74P CSA series uses three and four metal layers, respectively. The semiconductor process is adapted from Oki's production-proven 64-Mbit DRAM manufacturing process.

The 0.25 $\mu$ m family provides significant performance, density, and power improvement over previous 0.30 and 0.35 $\mu$ m technologies. An innovative 4-transistor cell structure, licensed from In-Chip Systems, Inc., provides 30 to 50% less power and 30 to 50% more usable gates than traditional cell designs. The Oki 0.25 $\mu$ m family operates using 2.5-V  $V_{DD}$  core with optimized 3-V I/O buffers. The 3-, 4-, and 5-layer metal MG113P/114P/115P SOG series contains 4 array bases, offering up to 588 I/O pads and over 2.4M raw gates. The 3-, 4-, and 5-layer metal MG73P/74P/75P CSA series contains 21 array bases, offering up to 868 I/O pads and over 5.4M raw gates. These SOG and CSA array sizes are designed to fit the most popular quad flat pack (QFP), low profile QFPs (LQFPs), thin QFPs (TQFPs), and plastic ball grid array (PBGA) packages.

The MG113P/114P/115P series SOG architecture allows rapid prototyping turnaround times (TATs), additionally offering the most cost-effective solution for pad-limited circuits (particularly the 3-layer metal MG113P series). The 3-layer-metal MG73P, 4-layer-metal MG74P and 5-layer-metal MG75P CSA series contains 21 array bases, offering a wider span of gate and I/O counts than the SOG series. Oki uses the Artisan Components memory compiler which provides high performance, embedded synchronous single- and dual-port RAM macrocells for CSA designs. As such, the MG73P/74P/75P series is suited to memory-intensive ASICs and high-volume designs where fine tuning of package size produces significant cost or real-estate savings.

## FEATURES

- 0.25 $\mu$ m drawn 3-, 4-, and 5-layer metal CMOS
- Optimized 2.5-V core
- Optimized 3-V I/O
- SOG and CSA architecture availability
- 77-ps typical gate propagation delay (for a 4x-drive inverter gate with a fanout of 2 and 0 mm of wire, operating at 2.5 V)
- Over 5.4M raw gates and 868 I/O pads using 60 $\mu$  staggered I/O
- User-configurable I/O with  $V_{SS}$ ,  $V_{DD}$ , TTL, 3-state, and 1- to 24-mA options
- Slew-rate-controlled outputs for low-radiated noise
- H-clock tree cells which reduces the maximum skew for clock signals
- Low 0.2 $\mu$ W/MHz/gate power dissipation
- User-configurable single- and dual-port memories
- Specialized IP cores and macrocells including 32-bit ARM7TDMI CPU, phase-locked loop (PLL), and peripheral component interconnect (PCI) cells
- Floorplanning for front-end simulation, back-end layout controls, and link to synthesis
- Joint Test Action Group (JTAG) boundary scan and scan path Automatic Test Pattern Generation (ATPG)
- Support for popular CAE systems including Cadence, IKOS, Mentor Graphics, Model Technology, Inc. (MTI), Synopsys, and Viewlogic

## MG113P/114P/115P/73P/74P/75P FAMILY LISTING

60µm Staggered PAD products						MG113P/73P Family 3LM Usable Gates	MG114P/74P Family 4LM Usable Gates	MG115P/75P Family 5LM Usable Gates
SOG Base Array	EA Base Array	No. of Pads	No. of Rows	No. of Columns	No. of Raw Gates			
	MG7xPB02	68	84	280	23,520		22,344	22,344
	MG7xPB04	108	144	480	69,120		65,664	65,664
	MG7xPB06	148	204	680	138,720		131,784	131,784
	MG7xPB08	188	264	880	232,320		218,381	220,704
	MG7xPB10	228	324	1,080	349,920		311,429	332,424
	MG7xPB12	268	384	1,280	491,520		412,877	466,944
MG11xP14	MG7xPB14	308	444	1,480	657,120	387,701	519,125	611,122
	MG7xPB16	348	504	1,680	846,720		635,040	745,114
MG11xP18	MG7xPB18	388	564	1,880	1,060,320	572,573	763,430	901,272
	MG7xPB20	428	624	2,080	1,297,920		882,586	1,025,357
MG11xP22	MG7xPB22	468	684	2,280	1,559,920	732,974	982,498	1,154,045
	MG7xPB24	508	744	2,480	1,845,120		1,107,072	1,310,035
	MG7xPB26	548	804	2,680	2,154,720		1,249,738	1,465,210
MG11xP28	MG7xPB28	588	864	2,880	2,488,320	1,094,861	1,393,459	1,642,291
	MG7xPB30	628	924	3,080	2,845,920		1,536,797	1,821,389
	MG7xPB32	668	984	3,280	3,227,520		1,678,310	2,001,062
	MG7xPB34	708	1,044	3,480	3,633,120		1,816,560	2,179,872
	MG7xPB36	748	1,104	3,680	4,062,720		1,950,106	2,356,378
	MG7xPB38	788	1,164	3,880	4,516,320		2,077,507	2,529,139
	MG7xPB40	828	1,224	4,080	4,993,920		2,197,325	2,696,717
	MG7xPB42	868	1,284	4,280	5,495,520		2,308,118	2,857,670

## ARRAY ARCHITECTURE

The primary components of a 0.25µm MG113P/114P/115P circuit include:

- I/O base cells
- 60µm pad pitch
- Configurable I/O pads for  $V_{DD}$ ,  $V_{SS}$ , or I/O (optimized 3-V I/O)
- $V_{DD}$  and  $V_{SS}$  pads dedicated to wafer probing
- Separate power bus for output buffers
- Separate power bus for internal core logic and input buffers
- Core base cells containing N-channel and P-channel pairs, arranged in column of gates
- Isolated gate structure for reduced input capacitance and increased routing flexibility
- Innovative 4-transistor core cell architecture, licensed from In-Chip Systems, Inc

Each array has 24 dedicated corner pads for power and ground use during wafer probing, with four pads per corner. The arrays also have separate power rings for the internal core functions ( $V_{DDC}$  and  $V_{SSC}$ ) and output drive transistors ( $V_{DDO}$  and  $V_{SSO}$ ).

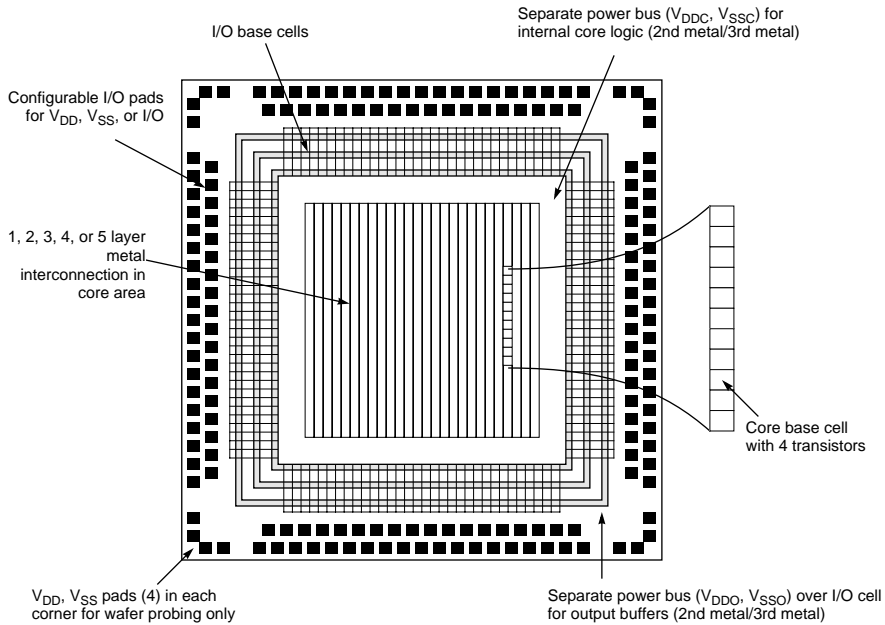

**Figure 7. MG115P Array Architecture**

**MG73P/74P/75P CSA Layout Methodology**

The procedure to design, place, and route a CSA follows.

1. Select suitable base array frame from the available predefined sizes. To select an array size:
  - Identify macrocell functions required and minimum array size to hold macrocell functions.
  - Add together all the area occupied by the required random logic and macrocells and select the optimum array.
2. Make a floor plan for the design’s megacells.
  - Oki Design Center engineers verify the master slice and review simulation.
  - Oki Design Center or customer engineers floorplan the array using Oki’s supported floor-planner or Cadence DP3 or Gambit GFP and customer performance specifications.
  - Using Oki CAD software, Design Center engineers remove the SOG transistors and replace them with diffused memory macrocells to the customer’s specifications.

Figure 8 shows an array base after placement of the optimized memory macrocells.

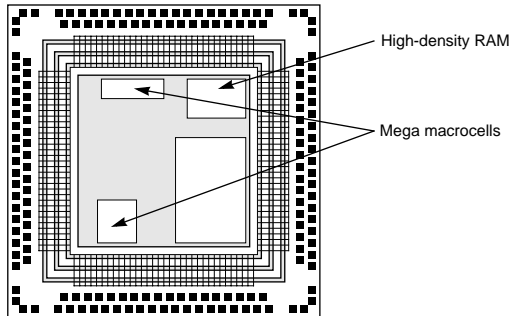

**Figure 8. Optimized Memory Macrocell Floor Plan**

3. Place and route logic into the array transistors.
  - Oki Design Center engineers use layout software and customer performance specifications to connect the random logic and optimized memory macrocells.

Figure 9 marks the area in which placement and routing is performed with cross hatching.

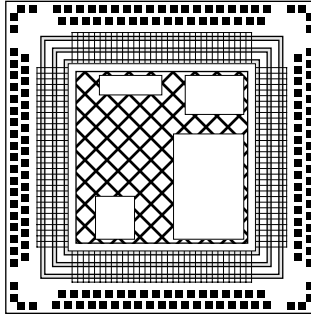

**Figure 9. Random Logic Place and Route**

## ELECTRICAL CHARACTERISTICS

### Absolute Maximum Ratings ( $V_{SS} = 0\text{ V}$ , $T_J = 25^\circ\text{C}$ ) [1]

Parameter	Symbol	Rated Value	Unit
Power supply voltage	$V_{DD}$ Core (2.5 V)	-0.3 to +3.6	V
	$V_{DD}$ I/O (3.3 V)	-0.3 to +4.6	
Input voltage (Input Buffer)	$V_I$	-0.3 to $V_{DD} + 0.3$	
Output voltage (Output Buffer)	$V_O$	-0.3 to $V_{DD} + 0.3$	
Input current (Input Buffer)	$I_I$	-10 to +10	mA
Output current per I/O (Output Buffer)	$I_O$	-24 to +24	
Storage temperature	$T_{STG}$	-65 to +150	$^\circ\text{C}$

1. Permanent device damage may occur if ABSOLUTE MAXIMUM RATINGS are exceeded. Functional operation should be restricted to the conditions in the other specifications of this data sheet. Exposure to absolute maximum rating conditions for extended periods may affect device reliability.

### Recommended Operating Conditions ( $V_{SS} = 0\text{ V}$ )

Parameter	Symbol	Rated Value	Unit
Power supply voltage	$V_{DD}$ Core (2.5 V)	+2.25 to +2.75	V
	$V_{DD}$ I/O (3.3 V)	+3.0 to +3.6	
Junction temperature	$T_J$	-40 to +85	$^\circ\text{C}$



**DC Characteristics ( $V_{DD}$  Core = 2.25 to 2.75 V,  $V_{DD}$  I/O = 3.0 to 3.6 V,  $V_{SS} = 0$  V,  $T_j = -40^\circ$  to  $+85^\circ$  C)**

Parameter	Symbol	Conditions	Rated Value			Unit
			Min.	Typ. [1]	Max.	
High-level input voltage	$V_{IH}$	TTL input (normal), $V_{DD} = V_{DD}$ I/O	2.0	–	$V_{DD} + 0.3$	V
Low-level input voltage	$V_{IL}$	TTL input (normal)	-0.3	–	0.8	
TTL-level Schmitt Trigger input buffer Threshold voltage	$V_{t+}$	TTL input	–	1.5	2.0	
	$V_{t-}$		0.7	1.0	–	
	$\Delta V_t$	$V_{t+} - V_{t-}$	0.4	0.5	–	
High-level output voltage (Output buffer)	$V_{OH}$	$I_{OH} = -100 \mu\text{A}$ , $V_{DD} = V_{DD}$ I/O	$V_{DD} - 0.2$	–	–	
		$I_{OH} = -1, -2, -4, -6, -8, -12, -24 \text{ mA}$	2.4	–	–	
Low-level output voltage (Output buffer)	$V_{OL}$	$I_{OL} = 100 \mu\text{A}$	–	–	0.2	
		$I_{OL} = 1, 2, 4, 6, 8, 12, 24 \text{ mA}$	–	–	0.4	
High-level input current (Input buffer)	$I_{IH}$	$V_{IH} = V_{DD}$	–	–	10	$\mu\text{A}$
		$V_{IH} = V_{DD}$ (50-k $\Omega$ pull-down)	10	66	200	
Low-level input current (Normal input buffer)	$I_{IL}$	$V_{IL} = V_{SS}$	-10	–	10	
		$V_{IL} = V_{SS}$ (50-k $\Omega$ pull-up)	-200	-66	-10	
		$V_{IL} = V_{SS}$ (3-k $\Omega$ pull-up)	-3.3	-1.1	-0.3	mA
3-state output leakage current (Normal input buffer)	$I_{OZH}$	$V_{OH} = V_{DD}$	-10	–	10	$\mu\text{A}$
		$V_{OH} = V_{DD}$ (50-k $\Omega$ pull-down)	10	66	200	
	$I_{OZL}$	$V_{OL} = V_{SS}$	-10	–	10	
		$V_{OL} = V_{SS}$ (50-k $\Omega$ pull-up)	-200	-66	-10	
		$V_{OL} = V_{SS}$ (3-k $\Omega$ pull-up)	-3.3	-1.1	-0.3	mA
Stand-by current [2]	$I_{DDQ}$	Output open, $V_{IH} = V_{DD}$ , $V_{IL} = V_{SS}$	Design Dependent			$\mu\text{A}$

1. Typical condition is  $V_{DD}$  I/O = 3.3 V,  $V_{DD}$  Core = 2.5 V, and  $T_j = 25^\circ\text{C}$  on a typical process.
2. RAM/ROM should be in powerdown mode.

**DC Characteristics ( $V_{DD}$  Core = 2.25 to 2.75 V,  $V_{DD}$  I/O = 3.0 to 3.6 V,  $V_{SS} = 0$  V,  $T_j = -40^\circ$  to  $+125^\circ$ C)**

Parameter	Symbol	Conditions	Rated Value			Unit
			Min.	Typ. <sup>[1]</sup>	Max.	
High-level input voltage	$V_{IH}$	TTL input (normal), $V_{DD}=V_{DD}$ I/O	2.0	–	$V_{DD} + 0.3$	V
Low-level input voltage	$V_{IL}$	TTL input (normal)	-0.3	–	0.8	
TTL-level Schmitt Trigger input buffer Threshold voltage	$V_{t+}$	TTL input	–	1.5	2.0	
	$V_{t-}$		0.7	1.0	–	
	$\Delta V_t$		$V_{t+} - V_{t-}$	0.4	0.5	
High-level output voltage (Output buffer)	$V_{OH}$	$I_{OH} = -100 \mu\text{A}$ , $V_{DD}=V_{DD}$ I/O	$V_{DD} - 0.2$	–	–	
		$I_{OH} = -1, -2, -4, -6, -8, -12, -24$ mA	2.35	–	–	
Low-level output voltage (Output buffer)	$V_{OL}$	$I_{OL} = 100 \mu\text{A}$	–	–	0.2	
		$I_{OL} = 1, 2, 4, 6, 8, 12, 24$ mA	–	–	0.45	
High-level input current (Input buffer)	$I_{IH}$	$V_{IH} = V_{DD}$	–	–	50	$\mu\text{A}$
		$V_{IH} = V_{DD}$ (50-k $\Omega$ pull-down)	10	66	200	
Low-level input current (Normal input buffer)	$I_{IL}$	$V_{IL} = V_{SS}$	-50	–	50	
		$V_{IL} = V_{SS}$ (50-k $\Omega$ pull-up)	-200	-66	-10	
		$V_{IL} = V_{SS}$ (3-k $\Omega$ pull-up)	-3.3	-1.1	-0.3	mA
3-state output leakage current (Normal input buffer)	$I_{OZH}$	$V_{OH} = V_{DD}$	-50	–	50	$\mu\text{A}$
		$V_{OH} = V_{DD}$ (50-k $\Omega$ pull-down)	10	66	200	
	$I_{OZL}$	$V_{OL} = V_{SS}$	-50	–	50	
		$V_{OL} = V_{SS}$ (50-k $\Omega$ pull-up)	-200	-66	-10	
		$V_{OL} = V_{SS}$ (3-k $\Omega$ pull-up)	-3.3	-1.1	-0.3	mA
Stand-by current <sup>[2]</sup>	$I_{DDQ}$	Output open, $V_{IH} = V_{DD}$ , $V_{IL} = V_{SS}$	Design Dependent			$\mu\text{A}$

1. Typical condition is  $V_{DD}$  I/O = 2.5 V,  $V_{DD}$  Core = 2.5 V, and  $T_j = 25^\circ$ C for a typical process.
2. RAM/ROM should be in powerdown mode.

**DC Characteristics ( $V_{DD}$  Core = 2.25 to 2.75 V,  $V_{DD}$  I/O = 2.25 to 2.75 V,  $V_{SS} = 0$  V,  $T_j = -40^\circ$  to  $+125^\circ$  C)**

Parameter	Symbol	Conditions	Rated Value			Unit
			Min.	Typ. [1]	Max.	
High-level input voltage	$V_{IH}$	TTL input (normal), $V_{DD}=V_{DD}$ I/O	1.7	-	$V_{DD} + 0.3$	V
Low-level input voltage	$V_{IL}$	TTL input (normal)	-0.3	-	0.7	
TTL-level Schmitt Trigger input buffer Threshold voltage	$V_{t+}$	TTL input (normal)	-	-	1.7	
	$V_{t-}$		0.6	-	-	
	$\Delta V_t$	$V_{t+} - V_{t-}$	-	0.4	-	
High-level output voltage (Output buffer)	$V_{OH}$	$I_{OH} = -100 \mu\text{A}$ , $V_{DD}=V_{DD}$ I/O	$V_{DD} - 0.2$	-	-	
		$I_{OH} = -0.5, -1, -2, -3, -4, -6, -12 \text{ mA}$	1.95	-	-	
Low-level output voltage (Output buffer)	$V_{OL}$	$I_{OL} = 100 \mu\text{A}$	-	-	0.2	
		$I_{OL} = -0.5, 1, 2, 3, 4, 6, 12 \text{ mA}$	-	-	0.45	
High-level input current (Input buffer)	$I_{IH}$	$V_{IH} = V_{DD}$	-50	-	50	
Low-level input current (Normal input buffer)	$I_{IL}$	$V_{IL} = V_{SS}$	-50	-	50	
		$V_{IL} = V_{SS}$ (3-k $\Omega$ pull-up)	-	-0.8	-	mA
3-state output leakage current (Normal input buffer)	$I_{OZH}$	$V_{OH} = V_{DD}$	-50	-	50	$\mu\text{A}$
		$V_{OL} = V_{SS}$	-50	-	50	
	$V_{OL} = V_{SS}$ (3-k $\Omega$ pull-up)	-	-0.8	-	mA	
Stand-by current [2]	$I_{DDQ}$	Output open, $V_{IH} = V_{DD}$ , $V_{IL} = V_{SS}$	Design Dependent			$\mu\text{A}$

1. Typical condition is  $V_{DD}$  I/O = 2.5 V,  $V_{DD}$  Core = 2.5 V, and  $T_j = 25^\circ\text{C}$  for a typical process.
2. RAM/ROM should be in powerdown mode.

**AC Characteristics (Core  $V_{DD} = 2.5\text{ V}$ ,  $V_{SS} = 0\text{ V}$ ,  $T_j = 25^\circ\text{C}$ )**

Parameter		Driving Type	Conditions <sup>[1]</sup> <sup>[2]</sup>	Rated Value <sup>[3]</sup>	Unit	
Internal gate propagation delay	Inverter	1X	F/O = 2, L = 0 mm $V_{DD} = 2.5\text{ V}$	0.080	ns	
		2X		0.072		
		4X		0.061		
	2-input NAND	1X		0.118		
		2X		0.102		
		4X		0.094		
	2-input NOR	1X		0.134		
		4X		0.127		
	Inverter	1X		F/O = 2, L = standard wire length $V_{DD} = 2.5\text{ V}$		0.204
		2X				0.159
		4X				0.108
	2-input NAND	1X				0.274
		2X				0.183
		4X				0.136
2-input NOR	1X	0.329				
	4X	0.219				
Toggle frequency			F/O = 1, L = 0 mm		1100	MHz

1. Input transition time in 0.15 ns / 2.5 V.
2. Typical condition is  $V_{DD} = 2.5\text{ V}$  and  $T_j = 25^\circ\text{C}$  for a typical process.
3. Rated value is calculated as an average of the L-H and H-L delay times of each macro type on a typical process.

**AC Characteristics (I/O  $V_{DD} = 3.3\text{ V}$ ,  $V_{SS} = 0\text{ V}$ ,  $T_j = 25^\circ\text{C}$ )**

Parameter		Conditions		Rated Value	Unit
Input buffer propagation delay		F/O = 2, L = standard wire length		0.311	ns
Output buffer propagation delay	Push-pull Normal output buffer	4 mA	CL = 20 pF	1.783	ns
		8 mA	CL = 50 pF	2.011	ns
		12mA	CL = 100 pF	2.562	ns
Output buffer transition time <sup>[1]</sup>	Push-pull Normal output buffer	12 mA	CL = 100 pF	3.325 (r)	ns
		12 mA	CL = 100 pF	3.043 (f)	ns

1. Output rising and falling times are both specified over a 10 to 90% range.

## MACRO LIBRARY

Oki Semiconductor supports a wide range of macrocells and macrofunctions, ranging from simple hard macrocells for basic Boolean operations to large, user-parameterizable macrofunctions. The following figure illustrates the main classes of macrocells and macrofunctions available.

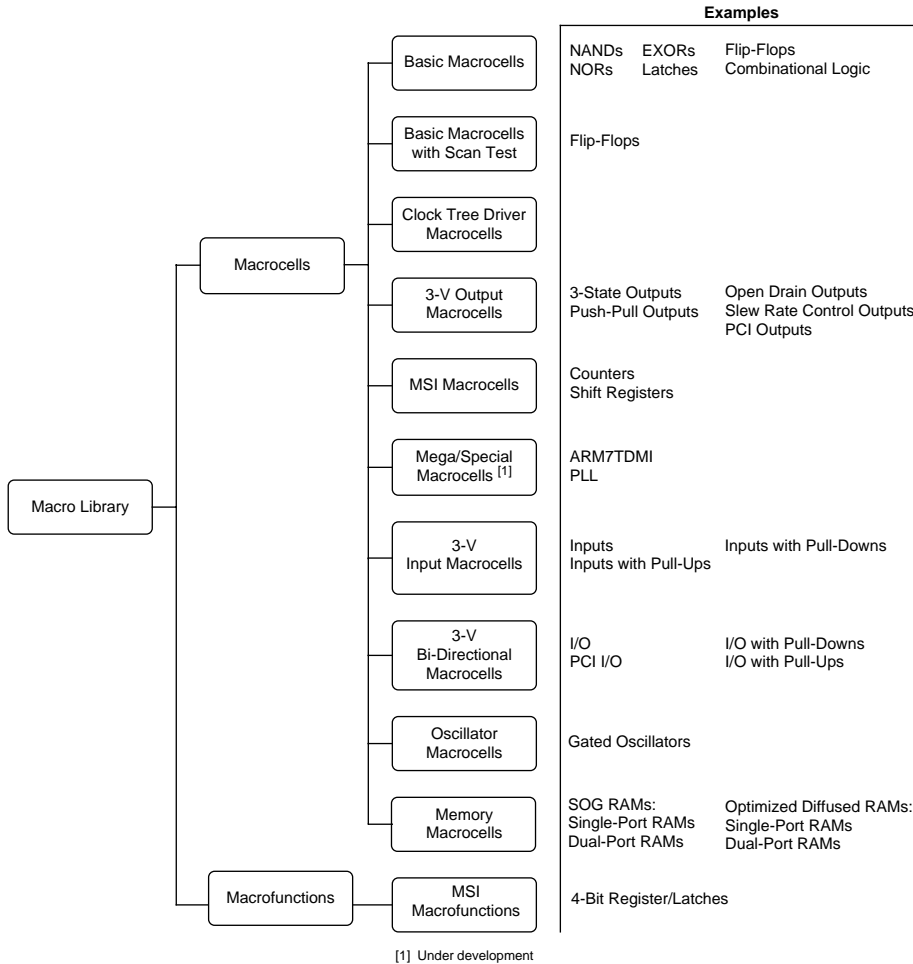
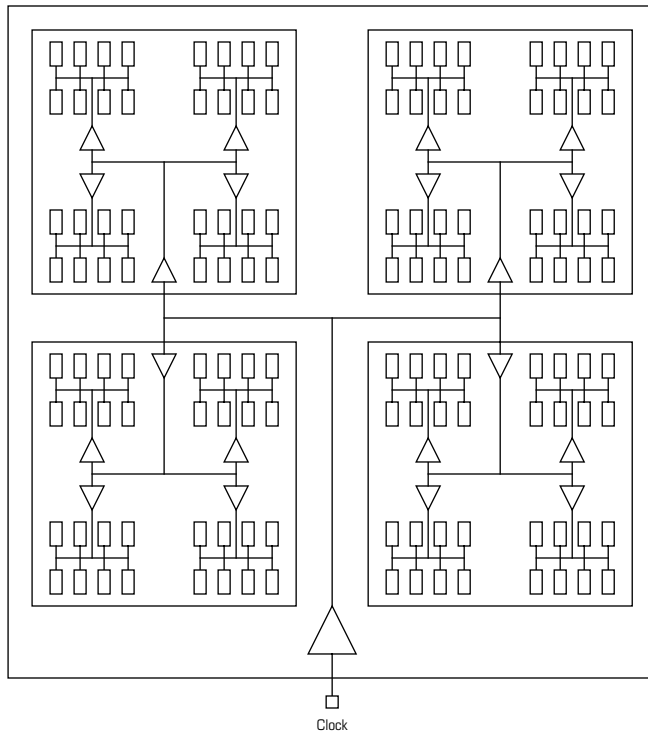

**Figure 10. Oki Macrocell and Macrofunction Library**

### Macrocells for Driving Clock Trees

Oki offers clock-tree drivers that minimize clock skew. The advanced layout software uses dynamic driver placement and sub-trunk allocation to optimize the clock-tree implementation for a particular circuit. Features of the clock-tree driver-macrocells include:

- True RC back annotation of the clock network
- Automatic fan-out balancing
- Dynamic sub-trunk allocation
- Single clock tree driver logic symbol
- Automatic branch length minimization
- Dynamic driver placement
- Up to four clock trunks



**Figure 11. Clock Tree Structure**

## OKI ADVANCED DESIGN CENTER CAD TOOLS

Oki's advanced design center CAD tools include support for the following:

- Floorplanning for front-end simulation and back-end layout control
- Clock tree structures improve first-time silicon success by eliminating clock skew problems
- JTAG Boundary scan support
- Power calculation which predicts circuit power under simulation conditions to accurately model package requirements

Vendor	Platform	Operating System <sup>[1]</sup>	Vendor Software/Revision <sup>[1]</sup>	Description
Cadence	HP9000, 7xx IBM RS6000 Sun <sup>®</sup> <sup>[2]</sup>	HP-UX AIX SunOS, Solaris	Composer™ Verilog™ NC-Verilog™ Veritime™ Verifault™ Concept™ <sup>[3]</sup> Leapfrog™	Design capture Simulation Simulation Timing analysis Fault grading Design capture VHDL simulation
IKOS	HP9000, 7xx, Sun <sup>[2]</sup>	HP-UX, SunOS, Solaris	NSIM Gemini/Voyager	Simulation
Mentor Graphics™	HP9000, 7xx Sun <sup>[2]</sup>	HP-UX SunOS, Solaris	IDEA™ QuickVHDL QuickSim II™ DFT Advisor Fastscan	Design capture VHDL simulation Logic simulation Test synthesis ATPG
Model Technology Inc. (MTI)	HP9000, 7xx Sun <sup>[2]</sup> PC	HP-UX SunOS, Solaris Win/NT™	V-System	VHDL simulation
Synopsys (Interface to Mentor Graphics, VIEWLogic)	IBM RS6000 HP9000, 7xx Sun <sup>[2]</sup>	AIX HP-UX SunOS, Solaris	Design Compiler™ HDL/VHDL Compiler™ Test Compiler™ VSS™	Compilation Design synthesis Test synthesis VHDL simulation
VIEWLogic	PC Sun <sup>[2]</sup>	Windows™, Win/NT™ <sup>[4]</sup> SunOS, Solaris	Powerview™ Fusion HDL	Simulation VHDL/Verilog™ Simulation

1. Contact Oki Application Engineering for current software versions.
2. Sun or Sun-compatible.
3. Sun and HP platform only.
4. In development.

## Design Process

The following figure illustrates the overall IC design process, also indicating the three main interface points between external design houses and Oki ASIC Application Engineering.

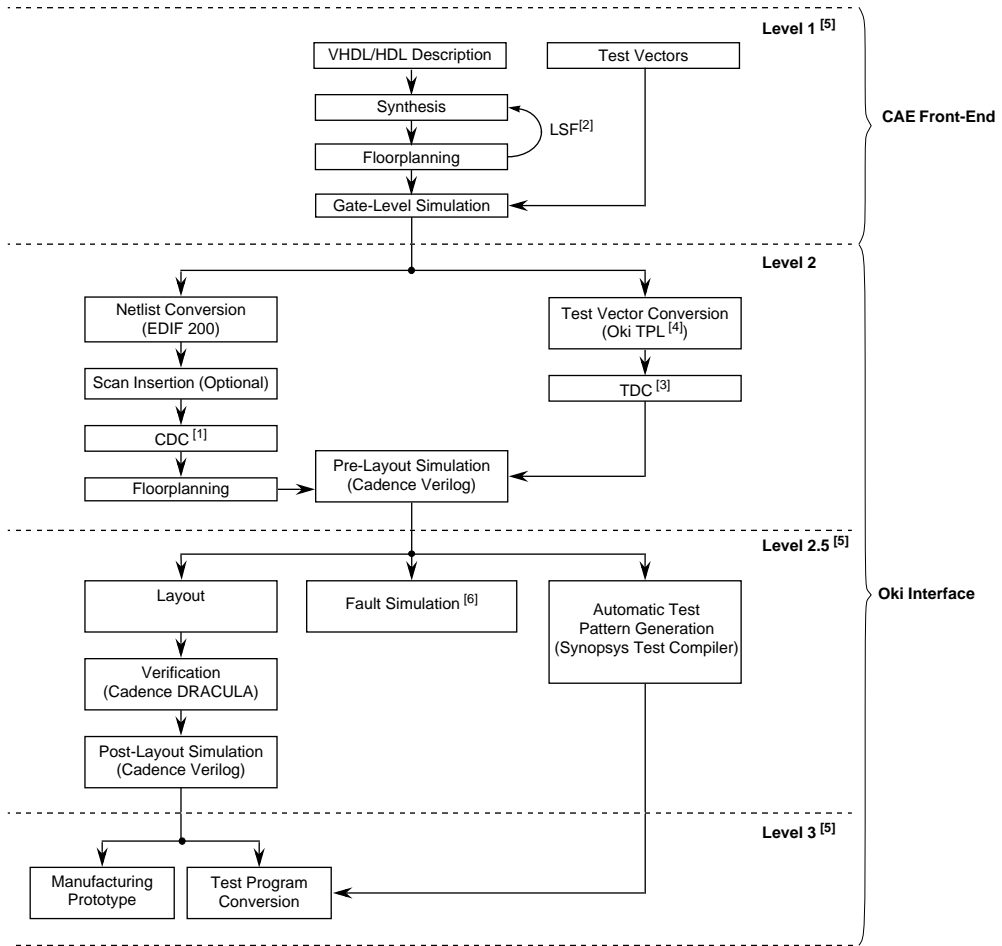

- [1] Oki's Circuit Data Check program (CDC) verifies logic design rules
- [2] Oki's Link to Synthesis Floorplanning toolset (LSF) transfers post-floorplanning timing for resynthesis
- [3] Oki's Test Data Check program (TDC) verifies test vector rules
- [4] Oki's Test Pattern Language (TPL)
- [5] Alternate Customer-Oki design interfaces available in addition to standard level 2
- [6] Standard design process includes fault simulation

**Figure 12. Oki's Design Process**



## Automatic Test Pattern Generation

Oki's 0.25µm ASIC technologies support ATPG using full scan-path design techniques, including the following:

- Increases fault coverage  $\geq 95\%$
- Uses Synopsys Test Compiler
- Automatically inserts scan structures
- Connects scan chains
- Traces and reports scan chains
- Checks for rule violations
- Generates complete fault reports
- Allows multiple scan chains
- Supports vector compaction

ATPG methodology is described in detail in Oki's *0.25µm Scan Path Application Note*.

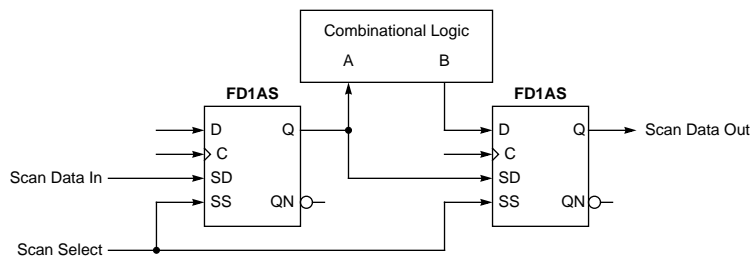

**Figure 13. Full Scan Path Configuration**

## Floorplanning Design Flow

Oki offers two floorplanning tools for high-density ASIC design: Cadence DP3, and Gambit GFP. The two main purposes for Oki's floorplanning tools are to:

- Ensure conformance of critical circuit performance specifications
- Shorten overall design TAT

In a traditional design approach with synthesis tools, timing violations after prelayout simulation are fixed by manual editing of the netlist. This process is difficult and time consuming. Also, there is no physical cluster information provided in the synthesis tool, and so it is difficult to synthesize logic using predicted interconnection delay due to wire length. Synthesis tools may therefore create over-optimized results.

To minimize these problems, Synopsys proposed a methodology called, "Links to Layout (LTL)". Based on this methodology, Oki developed an interface between Oki's Floorplanner and the Synopsys environment, called Link Synopsys to Floorplanner (LSF). As not every Synopsys user has access to the Synopsys Floorplan Management tool, Oki had developed the LSF system to support both users who can access Synopsys Floorplan Management and users who do not have access to Synopsys Floorplan Management.

More information on OKI's floorplanning capabilities is available in Oki's Application Note, *Using Oki's Floorplanner: Standalone Operation and Links to Synopsys*.

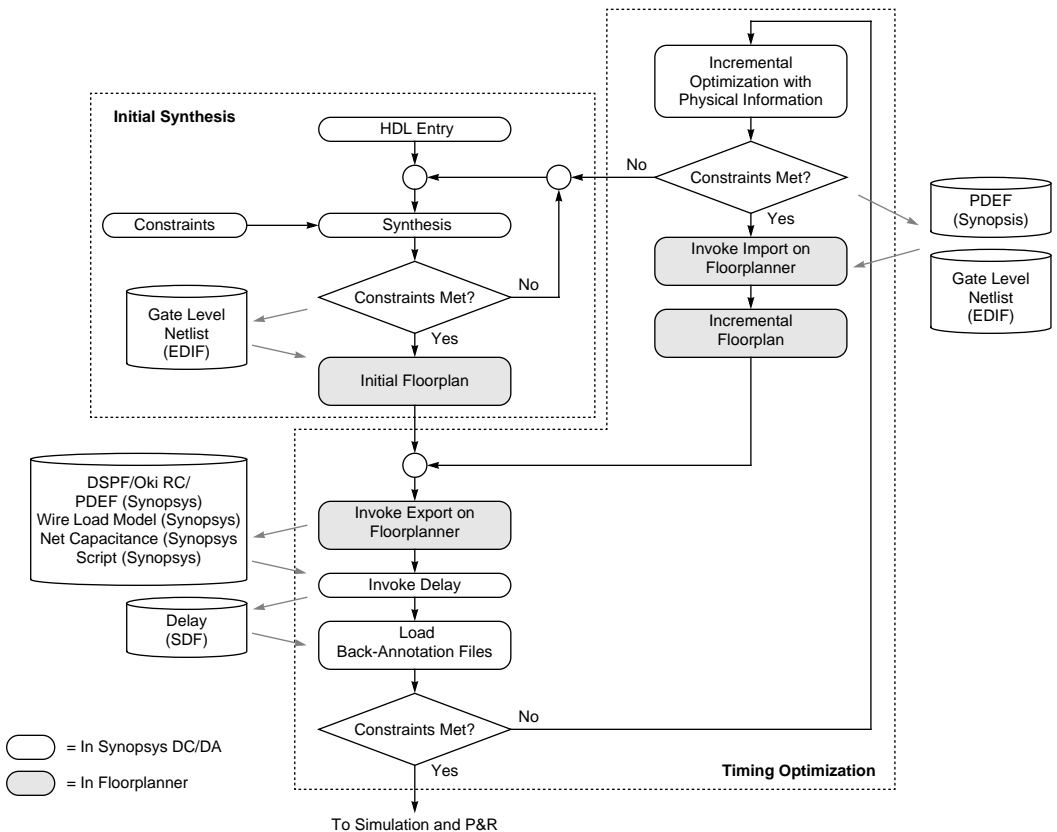

Figure 14. LSF System Design Flow

### IEEE JTAG Boundary Scan Support

Boundary scan offers efficient board-level and chip-level testing capabilities. Benefits resulting from incorporating boundary-scan logic into a design include:

- Improved chip-level and board-level testing and failure diagnostic capabilities
- Support for testing of components with limited probe access
- Easy-to-maintain testability and system self-test capability with on-board software
- Capability to fully isolate and test components on the scan path
- Built-in test logic that can be activated and monitored
- An optional Boundary Scan Identification (ID) Register

Oki's boundary scan methodology meets the JTAG Boundary Scan standard, IEEE 1149.1-1990. Oki supports boundary scan on both Sea of Gates (SOG) and Customer Structured Array (CSA) ASIC technologies. Either the customer or Oki can perform boundary-scan insertion. More information is available in Oki's *JTAG Boundary Scan Application Note*. (Contact the Oki Application Engineering Department for interface options.)

## PACKAGE OPTIONS

### TQFP, LQFP and QFP Package Menu

Base Array	Product Name	I/O Pads <sup>[1]</sup>	LQFP			QFP		TQFP	
			144	176	208	208	240	100	
MG11xP14	MG7xPB02	68						●	
	MG7xPB04	108						●	
	MG7xPB06	148						●	
	MG7xPB08	188						●	
	MG7xPB10	228			●	●		●	
	MG7xPB12	268	●		●	●		●	
	MG7xPB14	308	●	●	●	●		●	
	MG7xPB16	348	●	●	●	●		●	
	MG11xP18	MG7xPB18	388	●	●	●	●		●
		MG7xPB20	428	●	●	●	●		●
MG11xP22	MG7xPB22	468	●	●	●	●		●	
	MG7xPB24	508	●	●	●	●		●	
MG11xP28	MG7xPB26	548	●	●	●	●		●	
	MG7xPB28	588	●	●	●	●	●		
	MG7xPB30	628	●	●	●	●	●		
	MG7xPB32	668	●	●	●	●	●		
	MG7xPB34	708	●	●	●	●	●		
	MG7xPB36	748	●	●	●	●	●		
	MG7xPB38	788	●	●	●	●			
	MG7xPB40	828	●	●	●	●			
	MG7xPB42	868	●	●	●	●			
Body Size (mm)			20 x 20	24 x 24	28 x 28	28 x 28	32 x 32	14 x 14	
Lead Pitch (mm)			0.5	0.5	0.5	0.5	0.5	0.5	

1. I/O Pads can be used for input, output, bi-directional, power, or ground.

● = Available now

### BGA Package Menu

Base Array	Product Name	I/O Pads <sup>[1]</sup>	BGA			
			256	352	420	560
	MG7xPB02	68				
	MG7xPB04	108				
	MG7xPB06	148				
	MG7xPB08	188				
	MG7xPB10	228				
	MG7xPB12	268				
MG11xP14	MG7xPB14	308	●			
	MG7xPB16	348	●			
MG11xP18	MG7xPB18	388	●		●	
	MG7xPB20	428	●		●	
MG11xP22	MG7xPB22	468	●	●	●	
	MG7xPB24	508	●	●	●	
	MG7xPB26	548	●	●	●	
MG11xP28	MG7xPB28	588	●	●	●	
	MG7xPB30	628	●	●	●	
	MG7xPB32	668		●	●	
	MG7xPB34	708		●	●	●
	MG7xPB36	748		●		●
	MG7xPB38	788		●		●
	MG7xPB40	828		●		●
	MG7xPB42	868				●
Body Size (mm)			27x27	35x35	35x35	35x35
Lead Pitch (mm)			1.27	1.27	1.27	1.00
Ball Count			256	352	420	560
Signal I/O			231	304	352	400
Power Ball			12	16	32	80
GND Ball			13	32	36	80

1. I/O Pads can be used for input, output, bi-directional, power, or ground.

● = Available now

---

The information contained herein can change without notice owing to product and/or technical improvements.

Please make sure before using the product that the information you are referring to is up-to-date.

The outline of action and examples of application circuits described herein have been chosen as an explanation of the standard action and performance of the product. When you actually plan to use the product, please ensure that the outside conditions are reflected in the actual circuit and assembly designs.

Oki assumes no responsibility or liability whatsoever for any failure or unusual or unexpected operation resulting from misuse, neglect, improper installation, repair, alteration or accident, improper handling, or unusual physical or electrical stress including, but not limited to, exposure to parameters outside the specified maximum ratings or operation outside the specified operating range.

Neither indemnity against nor license of a third party's industrial and intellectual property right, etc. is granted by us in connection with the use of product and/or the information and drawings contained herein. No responsibility is assumed by us for any infringement of a third party's right which may result from the use thereof.

When designing your product, please use our product below the specified maximum ratings and within the specified operating ranges, including but not limited to operating voltage, power dissipation, and operating temperature.

The products listed in this document are intended for use in general electronics equipment for commercial applications (e.g., office automation, communication equipment, measurement equipment, consumer electronics, etc.). These products are not authorized for use in any system or application that requires special or enhanced quality and reliability characteristics nor in any system or application where the failure of such system or application may result in the loss or damage of property or death or injury to humans. Such applications include, but are not limited to: traffic control, automotive, safety, aerospace, nuclear power control, and medical, including life support and maintenance.

Certain parts in this document may need governmental approval before they can be exported to certain countries. The purchaser assumes the responsibility of determining the legality of export of these parts and will take appropriate and necessary steps, at their own expense, for export to another country.

Copyright 1999 Oki Semiconductor

Oki Semiconductor reserves the right to make changes in specifications at anytime and without notice. This information furnished by Oki Semiconductor in this publication is believed to be accurate and reliable. However, no responsibility is assumed by Oki Semiconductor for its use; nor for any infringements of patents or other rights of third parties resulting from its use. No license is granted under any patents or patent rights of Oki.

---



# OKI REGIONAL SALES OFFICES

---

## **Northwest Area**

785 N. Mary Avenue  
Sunnyvale, CA 94086  
Tel: 408/720-8940  
Fax: 408/720-8965

## **North Central Area**

300 Park Blvd.  
Suite 365  
Itasca, IL 60143  
Tel: 630/250-1313  
Fax: 630/250-1414

## **Northeast Area**

138 River Road  
Shattuck Office Center  
Andover, MA 01810  
Tel: 978/688-8687  
Fax: 978/688-8896

## **Southwest Area**

2302 Martin Street  
Suite 250  
Irvine, CA 92715  
Tel: 949/752-1843  
Fax: 949/752-2423

## **Southeast Area**

1590 Adamson Parkway  
Suite 220  
Morrow, GA 30260  
Tel: 770/960-9660  
Fax: 770/960-9682

### **Oki Web Site:**

*<http://www.okisemi.com>*

### **For Oki Literature:**

*Call toll free 1-800-OKI-6388  
(6 a.m. to 5 p.m. Pacific Time)*

**Oki Stock No: 320062-003**



# **Oki Semiconductor**

### **Corporate Headquarters**

785 N. Mary Avenue  
Sunnyvale, CA 94086-2909  
Tel: 408/720-1900  
Fax: 408/720-1918