

Hybrid Power Module

Integrated Power Stage for 5 hp Motor Drives

(This device is not recommended for new designs)
(This device is replaced by MHPM7A25S120DC3)

This module integrates a 3-phase input rectifier bridge, 3-phase output inverter and brake transistor/diode in a single convenient package. The output inverter utilizes advanced insulated gate bipolar transistors (IGBT) matched with free-wheeling diodes to give optimal dynamic performance. It has been configured for use as a three-phase motor drive module or for many other power switching applications. The top connector pins have been designed for easy interfacing to the user's control board.

- Short Circuit Rated 10 μ s @ 25°C, 600V
- Pin-to-Baseplate Isolation exceeds 2500 Vac (rms)
- Convenient Package Outline
- UL  Recognized
- Access to Positive and Negative DC Bus
- Visit our website at <http://www.mot-sps.com/tsg/>

MHPM7B25A120B

**25 AMP, 1200 VOLT
HYBRID POWER MODULE**

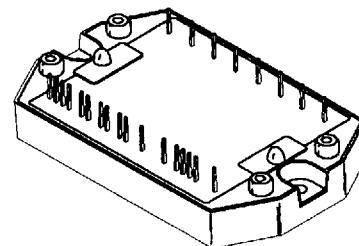

PLASTIC PACKAGE
CASE 440A-02, Style 1

MAXIMUM DEVICE RATINGS (T_J = 25°C unless otherwise noted)

Rating	Symbol	Value	Unit
INPUT RECTIFIER BRIDGE			
Peak Repetitive Reverse Voltage (T _J = 125°C)	V _{RRM}	1200	V
Average Output Rectified Current	I _O	25	A
Peak Non-Repetitive Surge Current(1/2 cycle)(1)	I _{FSM}	200	A
OUTPUT INVERTER			
IGBT Reverse Voltage	V _{CES}	1200	V
Gate-Emitter Voltage	V _{GES}	± 20	V
Continuous IGBT Collector Current	I _{Cmax}	25	A
Peak Repetitive IGBT Collector Current(2)	I _{C(pk)}	50	A
Continuous Free-Wheeling Diode Current	I _{Fmax}	25	A
Peak Repetitive Free-Wheeling Diode Current(2)	I _{F(pk)}	50	A
IGBT Power Dissipation per die (T _C = 95°C)	P _D	75	W
Free-Wheeling Diode Power Dissipation per die (T _C = 95°C)	P _D	40	W
Junction Temperature Range	T _J	- 40 to +125	°C
Short Circuit Duration (V _{CE} = 600V, T _J = 25°C)	t _{sc}	10	μs

(1) 1 cycle = 50 or 60 Hz

(2) 1.0 ms = 1.0% duty cycle

REV 1

© Motorola, Inc. 1998



MHPM7B25A120B**MAXIMUM DEVICE RATINGS** ($T_J = 25^\circ\text{C}$ unless otherwise noted)

Rating	Symbol	Value	Unit
BRAKE CIRCUIT			
IGBT Reverse Voltage	V_{CES}	1200	V
Gate-Emitter Voltage	V_{GES}	± 20	V
Continuous IGBT Collector Current	I_{Cmax}	25	A
Peak Repetitive IGBT Collector Current ⁽²⁾	$I_{C(pk)}$	50	A
IGBT Power Dissipation	P_D	75	W
Diode Reverse Voltage	V_{RRM}	1200	V
Continuous Output Diode Current	I_{Fmax}	25	A
Peak Output Diode Current	$I_{F(pk)}$	50	A
TOTAL MODULE			
Isolation Voltage (47–63 Hz, 1 min. duration)	V_{iso}	2500	V _{ac}
Operating Case Temperature Range	T_C	-40 to +90	$^\circ\text{C}$
Storage Temperature Range	T_{stg}	-40 to +125	$^\circ\text{C}$
Mounting Torque	—	6.0	lb•in

(1) 1 cycle = 50 or 60 Hz

(2) 1.0 ms = 1.0% duty cycle

ELECTRICAL CHARACTERISTICS ($T_J = 25^\circ\text{C}$ unless otherwise noted)

Characteristic	Symbol	Min	Typ	Max	Unit
INPUT RECTIFIER BRIDGE					
Reverse Leakage Current ($V_{RRM} = 1200\text{ V}$)	I_R	—	5.0	50	μA
Forward Voltage ($I_F = 25\text{ A}$)	V_F	—	2.5	2.85	V
Thermal Resistance (Each Die)	$R_{\theta JC}$	—	—	2.2	$^\circ\text{C/W}$
OUTPUT INVERTER					
Gate-Emitter Leakage Current ($V_{CE} = 0\text{ V}$, $V_{GE} = \pm 20\text{ V}$)	I_{GES}	—	—	± 20	μA
Collector-Emitter Leakage Current ($V_{CE} = 1200\text{ V}$, $V_{GE} = 0\text{ V}$)	I_{CES}	—	6.0	100	μA
		—	2000		
Gate-Emitter Threshold Voltage ($V_{CE} = V_{GE}$, $I_C = 10\text{ mA}$)	$V_{GE(th)}$	4.0	6.0	8.0	V
Collector-Emitter Breakdown Voltage ($I_C = 10\text{ mA}$, $V_{GE} = 0$)	$V_{(BR)CES}$	1200	—	—	V
Collector-Emitter Saturation Voltage ($V_{GE} = 15\text{ V}$, $I_C = 25\text{ A}$)	$V_{CE(SAT)}$	—	2.5	3.5	V
Input Capacitance ($V_{GE} = 0\text{ V}$, $V_{CE} = 10\text{ V}$, $f = 1.0\text{ MHz}$)	C_{ies}	—	4540	—	pF
Input Gate Charge ($V_{CE} = 600\text{ V}$, $I_C = 25\text{ A}$, $V_{GE} = +15\text{ V}$)	Q_T	—	165	—	nC
Fall Time — Inductive Load ($V_{CE} = 600\text{ V}$, $I_C = 25\text{ A}$, $V_{GE} = +15\text{ V}$, $R_{G(off)} = 20\ \Omega$)	t_f	—	350	500	ns
Turn-On Energy ($I_C = 25\text{ A}$, $V_{CE} = 600\text{ V}$, $R_{G(on)} = 180\ \Omega$)	E_{on}	—	—	9.0	mJ
Turn-Off Energy ($I_C = 25\text{ A}$, $V_{CE} = 600\text{ V}$, $R_{G(off)} = 20\ \Omega$)	E_{off}	—	—	4.5	mJ
Free Wheeling Diode Forward Voltage ($I_F = 16\text{ A}$, $V_{GE} = 0\text{ V}$)	V_F	—	1.9	2.4	V
Free Wheeling Diode Reverse Recovery Time ($I_F = 25\text{ A}$, $V = 600\text{ V}$, $dI/dt = 200\text{ A}/\mu\text{s}$)	t_{rr}	—	150	250	ns
Free Wheeling Diode Stored Charge ($I_F = 25\text{ A}$, $V = 600\text{ V}$, $dI/dt = 200\text{ A}/\mu\text{s}$)	Q_{rr}	—	—	1050	nC
Thermal Resistance — IGBT (Each Die)	$R_{\theta JC}$	—	—	1.4	$^\circ\text{C/W}$
Thermal Resistance — Free-Wheeling Diode (Each Die)	$R_{\theta JC}$	—	—	2.2	$^\circ\text{C/W}$

ELECTRICAL CHARACTERISTICS ($T_J = 25^\circ\text{C}$ unless otherwise noted)

Characteristic	Symbol	Min	Typ	Max	Unit
BRAKE CIRCUIT					
Gate-Emitter Leakage Current ($V_{CE} = 0\text{ V}$, $V_{GE} = \pm 20\text{ V}$)	I_{GES}	—	—	± 20	μA
Collector-Emitter Leakage Current ($V_{CE} = 1200\text{ V}$, $V_{GE} = 0\text{ V}$) $T_J = 25^\circ\text{C}$ $T_J = 125^\circ\text{C}$	I_{CES}	— —	6.0 2000	100	μA
Gate-Emitter Threshold Voltage ($V_{CE} = V_{GE}$, $I_C = 10\text{ mA}$)	$V_{GE(th)}$	4.0	6.0	8.0	V
Collector-Emitter Breakdown Voltage ($I_C = 10\text{ mA}$, $V_{GE} = 0$)	$V_{(BR)CES}$	1200	—	—	V
Collector-Emitter Saturation Voltage ($V_{GE} = 15\text{ V}$, $I_C = 25\text{ A}$)	$V_{CE(SAT)}$	—	2.5	3.5	V
Input Capacitance ($V_{GE} = 0\text{ V}$, $V_{CE} = 10\text{ V}$, $f = 1.0\text{ MHz}$)	C_{ies}	—	4500	—	pF
Input Gate Charge ($V_{CE} = 600\text{ V}$, $I_C = 25\text{ A}$, $V_{GE} = +15\text{ V}$)	Q_T	—	165	—	nC
Fall Time — Inductive Load ($V_{CE} = 600\text{ V}$, $I_C = 25\text{ A}$, $V_{GE} = +15\text{ V}$, $R_{G(off)} = 20\ \Omega$)	t_f	—	350	500	ns
Turn-On Energy ($I_C = 25\text{ A}$, $V_{CE} = 600\text{ V}$, $R_{G(on)} = 180\ \Omega$)	E_{on}	—	—	9.0	mJ
Turn-Off Energy ($I_C = 25\text{ A}$, $V_{CE} = 600\text{ V}$, $R_{G(off)} = 20\ \Omega$)	E_{off}	—	—	4.5	mJ
Output Diode Forward Voltage ($I_F = 25\text{ A}$)	V_F	—	1.9	2.4	V
Output Diode Reverse Leakage Current	I_R	—	—	50	μA
Thermal Resistance — IGBT	$R_{\theta JC}$	—	—	1.4	$^\circ\text{C/W}$
Thermal Resistance — Output Diode	$R_{\theta JC}$	—	—	2.2	$^\circ\text{C/W}$

Typical Characteristics

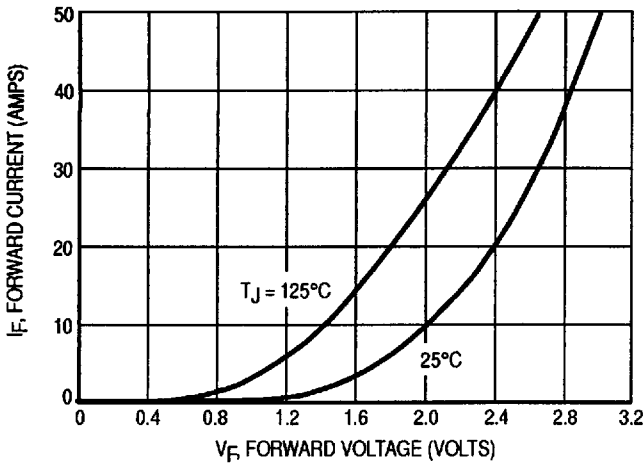

Figure 1. Forward Characteristics - Input Rectifier

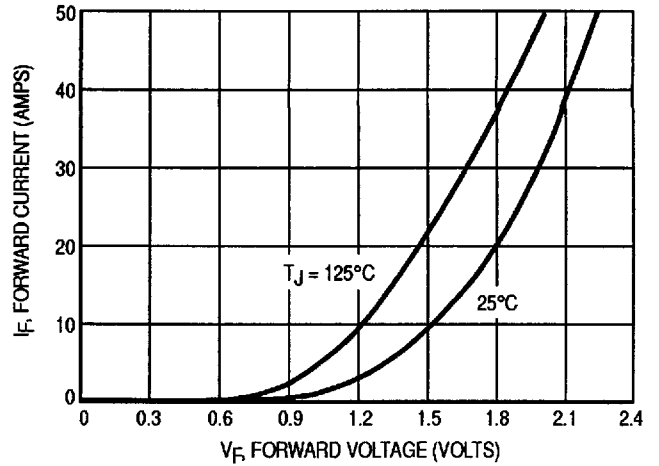

Figure 2. Forward Characteristics Free-Wheeling Diode

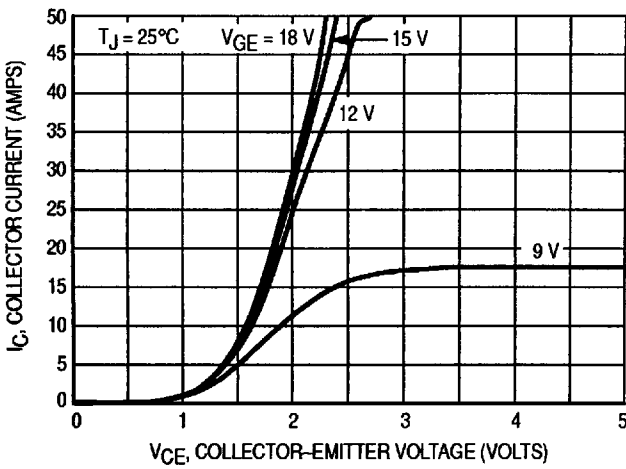

Figure 3. Forward Characteristics, $T_J = 25^\circ\text{C}$

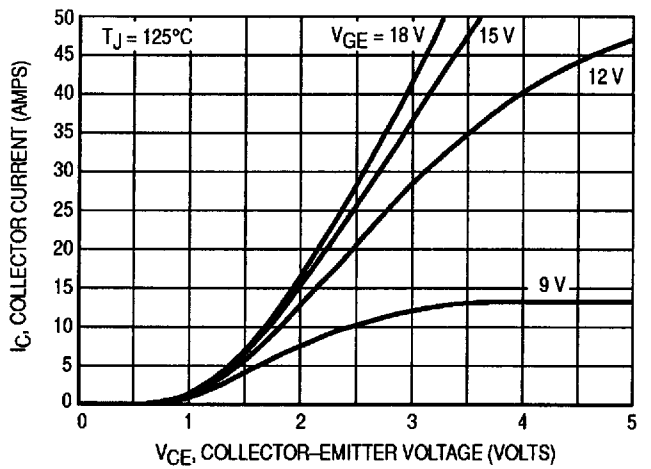

Figure 4. Forward Characteristics, $T_J = 125^\circ\text{C}$

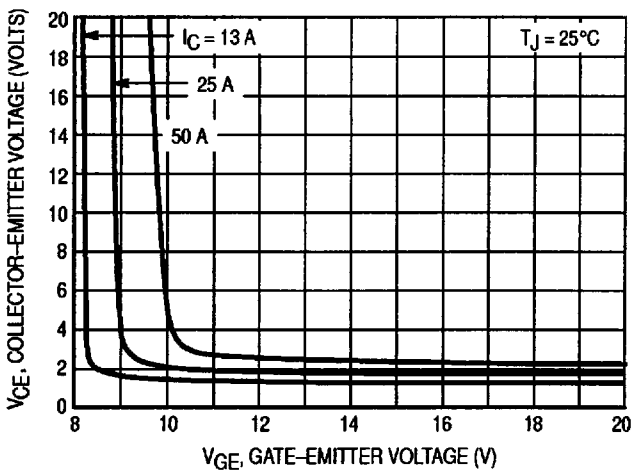

Figure 5. Collector-Emitter Voltage versus Gate-Emitter Voltage

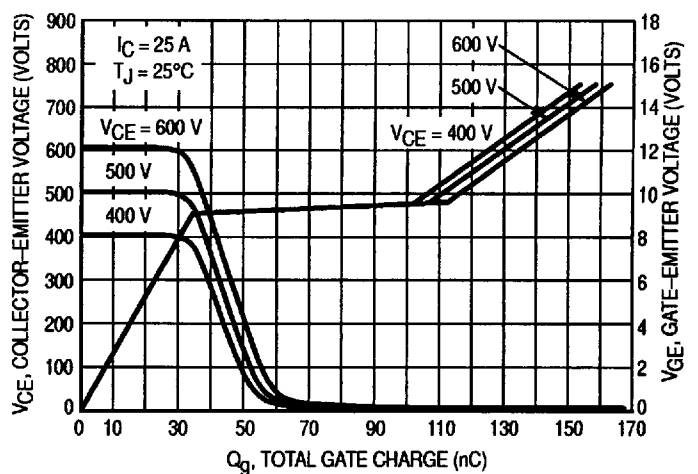

Figure 6. Collector-Emitter and Gate-Emitter Voltages versus Total Gate Charge

Typical Characteristics

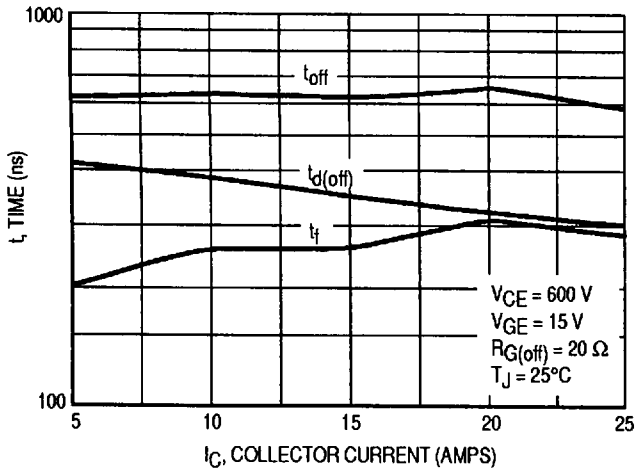

Figure 7. Inductive Switching Times versus Collector Current, $T_J = 25^\circ\text{C}$

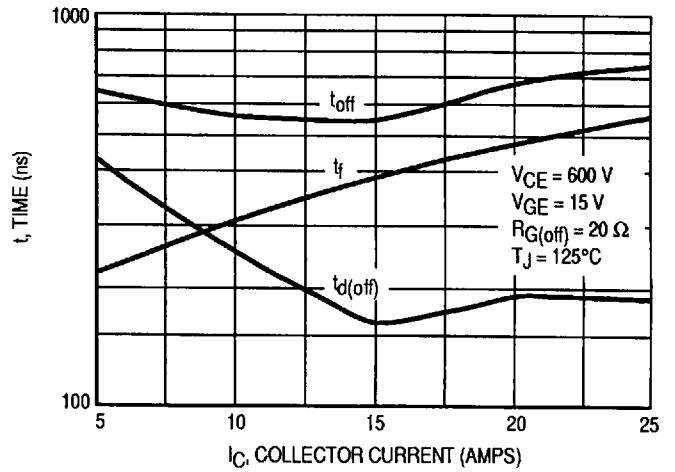

Figure 8. Inductive Switching Times versus Collector Current, $T_J = 125^\circ\text{C}$

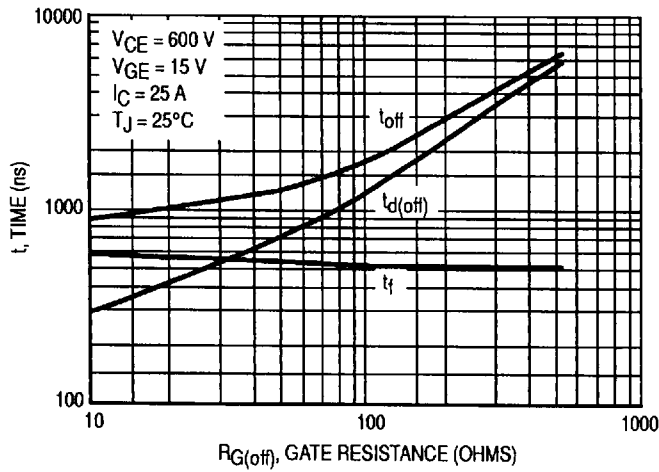

Figure 9. Inductive Switching Times versus Gate Resistance, $T_J = 25^\circ\text{C}$

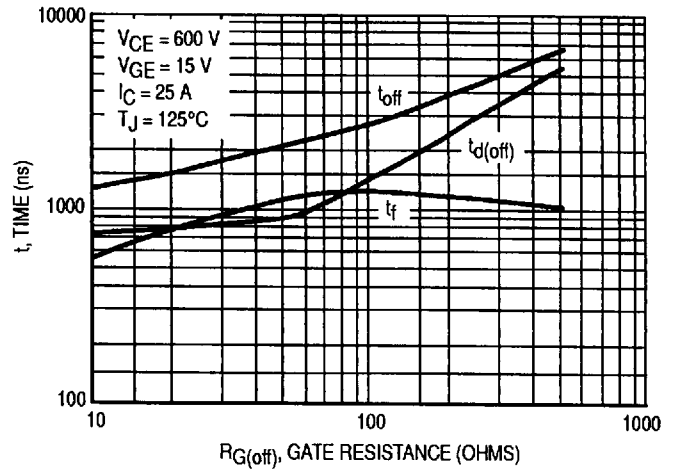

Figure 10. Inductive Switching Times versus Gate Resistance, $T_J = 125^\circ\text{C}$

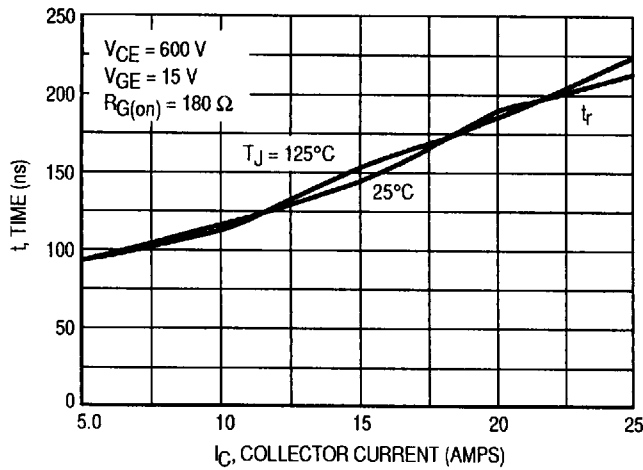

Figure 11. Inductive Switching Times versus Collector Current

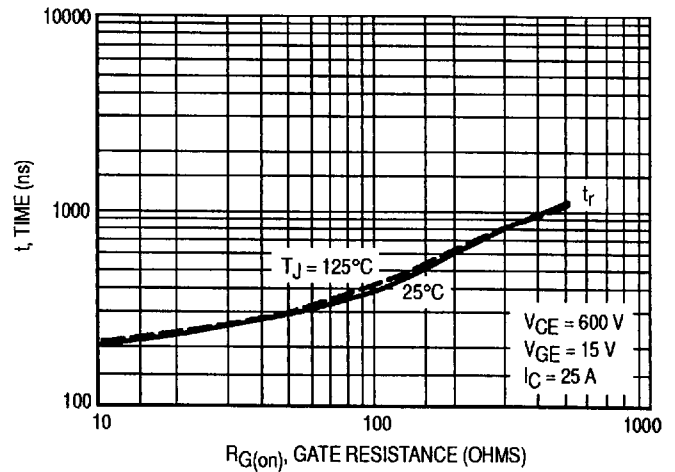

Figure 12. Inductive Switching Times versus Gate Resistance

Typical Characteristics

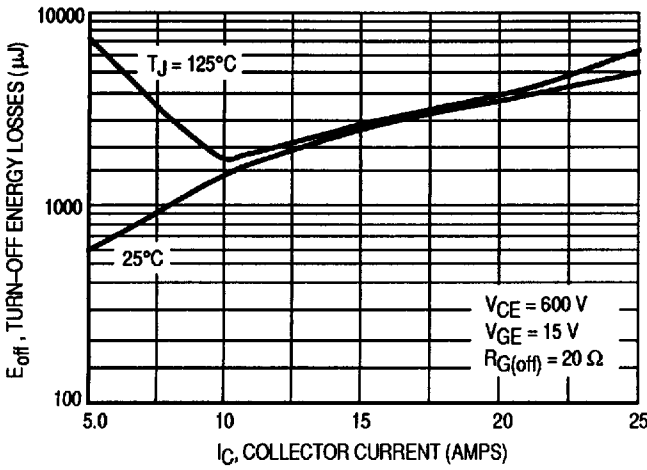

Figure 13. Turn-Off Energy Losses versus Collector Current

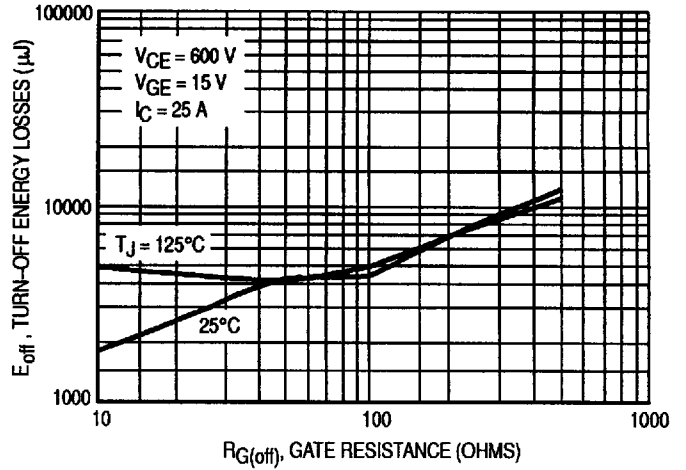

Figure 14. Turn-Off Energy Losses versus Gate Resistance

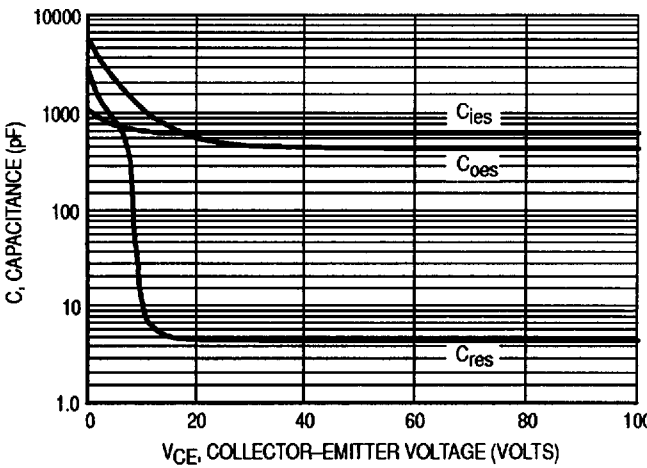

Figure 15. Capacitance Variation

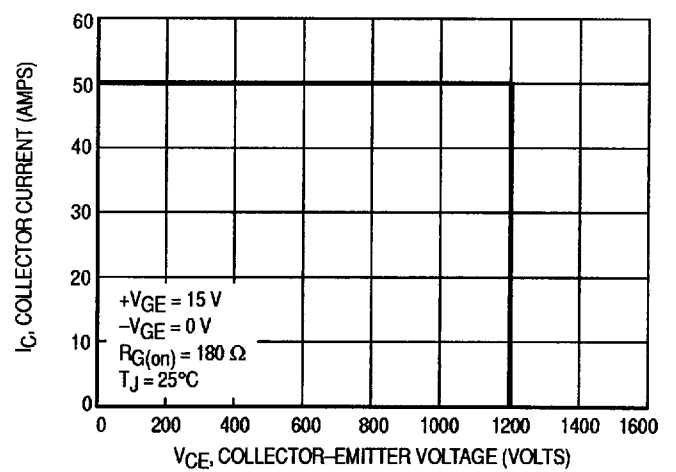

Figure 16. Reversed Biased Safe Operating Area (RBSOA)

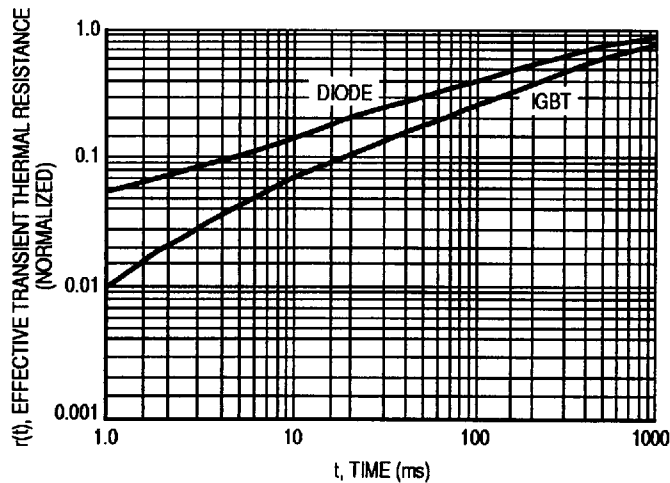

Figure 17. Thermal Response

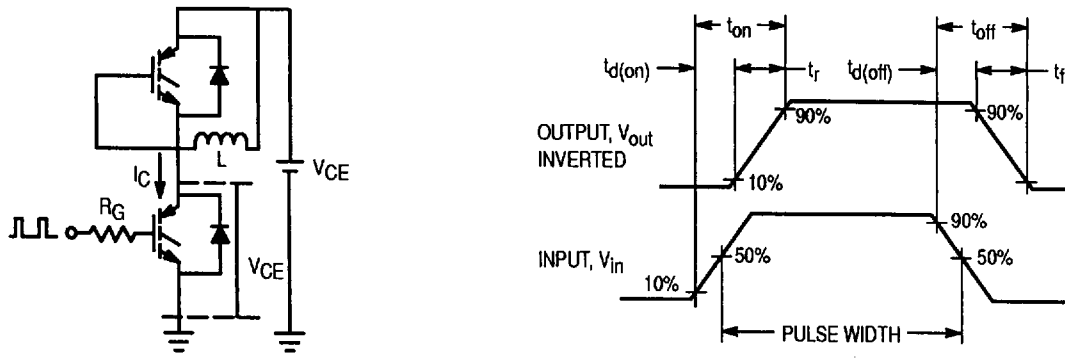
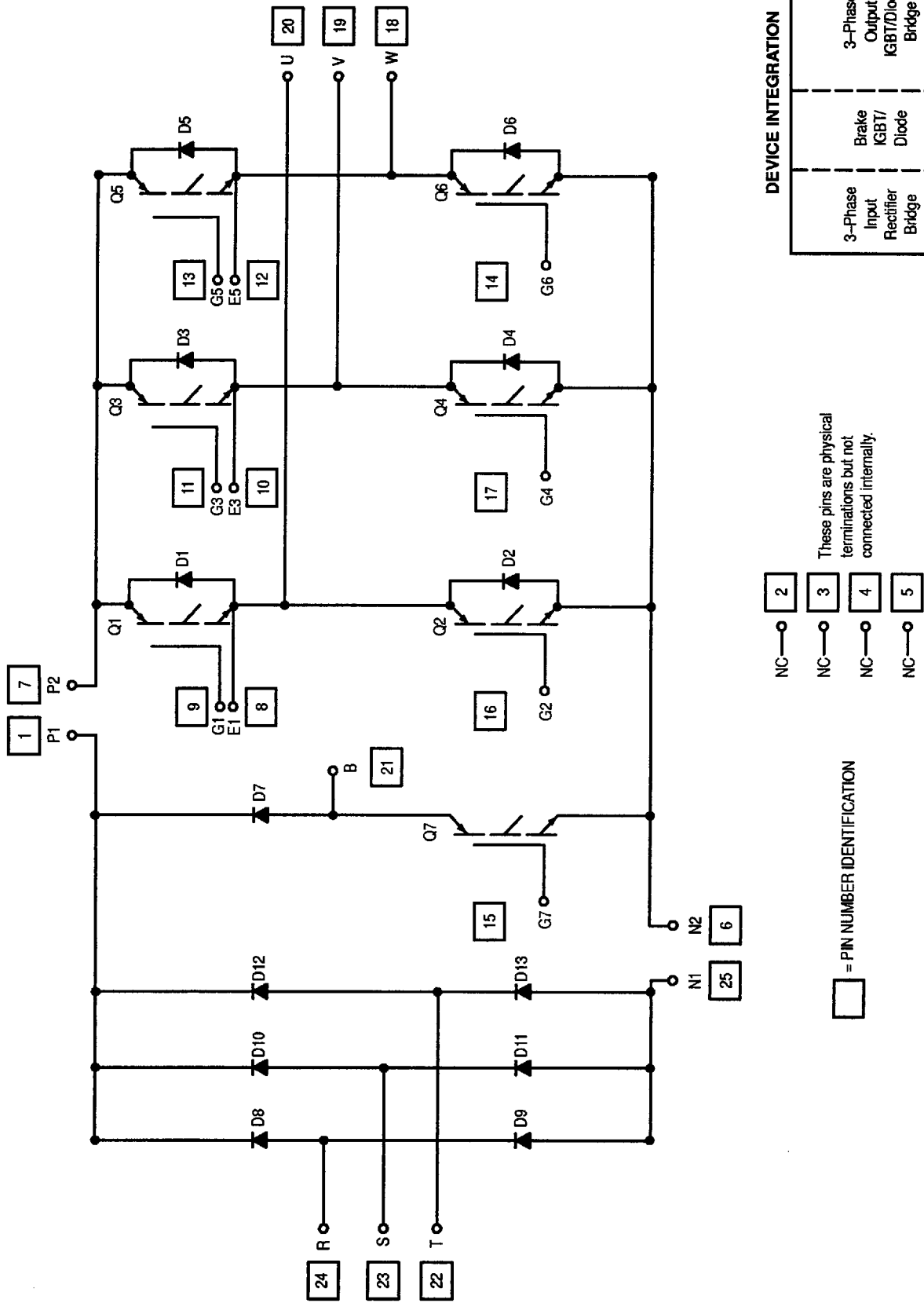

Figure 18. Inductive Switching Time Test Circuit and Timing Chart



DEVICE INTEGRATION

3-Phase Input Rectifier Bridge	Brake IGBT/Diode	3-Phase Output IGBT/Diode Bridge
--------------------------------	------------------	----------------------------------

These pins are physical terminations but not connected internally.

- 2 NC
- 3 NC
- 4 NC
- 5 NC

□ = PIN NUMBER IDENTIFICATION

Figure 19. Integrated Power Stage Schematic

PACKAGE DIMENSIONS

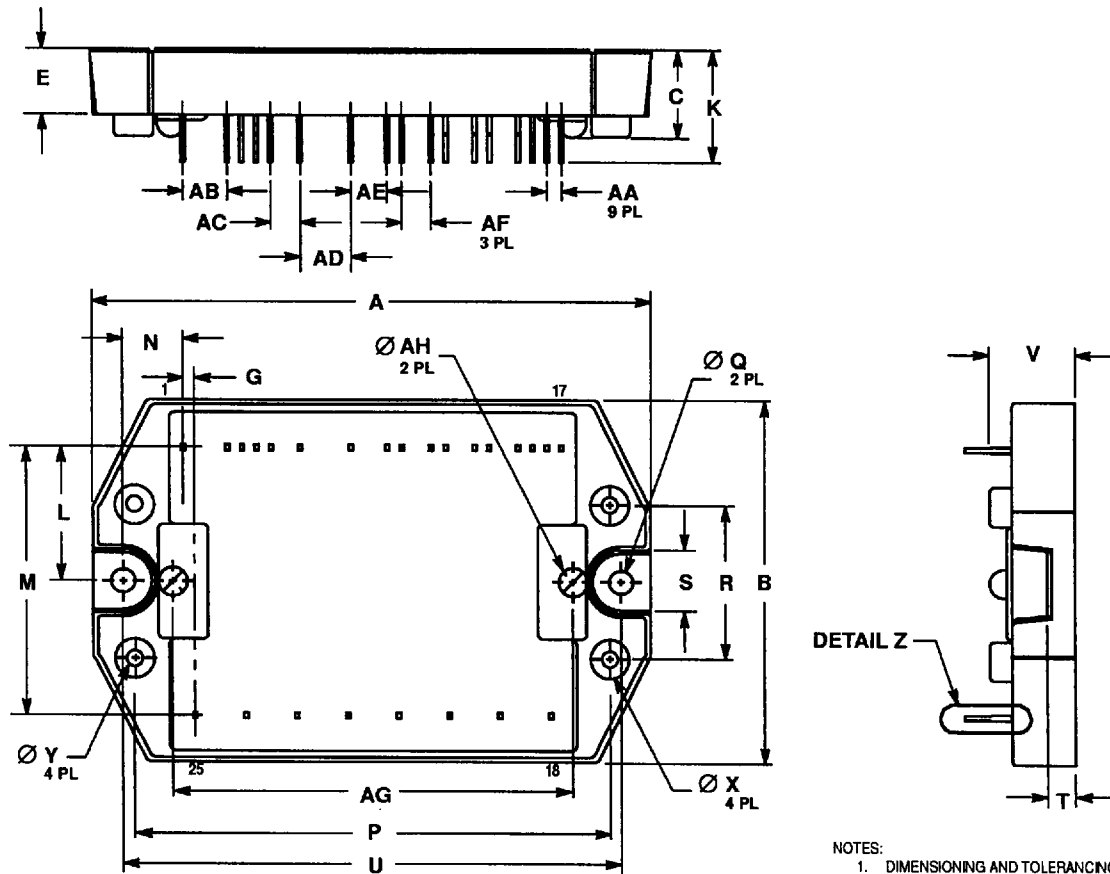

- NOTES:
1. DIMENSIONING AND TOLERANCING PER ANSI Y14.5M, 1982.
 2. CONTROLLING DIMENSION: MILLIMETER.
 3. LEAD LOCATION DIMENSIONS (ie: M, G, AA...) ARE TO THE CENTER OF THE LEAD.

DIM	MILLIMETERS		INCHES	
	MIN	MAX	MIN	MAX
A	97.54	98.55	3.840	3.880
B	62.74	63.75	2.470	2.510
C	14.60	15.88	0.575	0.625
D	0.56	0.97	0.022	0.038
E	10.80	12.06	0.425	0.475
F	0.81	1.22	0.032	0.048
G	1.60	2.21	0.063	0.087
H	8.58	9.19	0.338	0.362
J	0.56	0.97	0.022	0.038
K	18.80	20.57	0.740	0.810
L	22.86	23.88	0.900	0.940
M	46.23	47.24	1.820	1.860
N	9.78	11.05	0.385	0.435
P	82.55	83.57	3.250	3.290
Q	4.01	4.62	0.158	0.182
R	26.42	27.43	1.040	1.080
S	12.06	12.95	0.475	0.515
T	4.32	5.33	0.170	0.210
U	86.36	87.38	3.400	3.440
V	14.22	15.24	0.560	0.600
X	6.55	7.16	0.258	0.282
Y	2.49	3.10	0.098	0.122
AA	2.24	2.84	0.088	0.112
AB	7.32	7.92	0.288	0.312
AC	4.78	5.38	0.188	0.212
AD	8.58	9.19	0.338	0.362
AE	6.05	6.65	0.238	0.262
AF	4.78	5.38	0.188	0.212
AG	69.34	70.36	2.730	2.770
AH	—	5.08	—	0.200

CASE 440A-02
ISSUE A