

Doc. No.	413-212-112
Doc. version	3
Effective date	2001.8.30
Total pages	21
(Not include this cover page)	

Product Specification

3.5" COLOR TFT-LCD MODULE

MODEL NAME: H035QR01 Ver.0 (UR035Q01)

- Preliminary Specification
 Final Specification

Note: The content of this specification is subject to change.

© 2001 AU Optronics
All Rights Reserved,
Do Not Copy.

Contents:

A. General specifications	P 3
B. Electrical specifications	P 4
1. Pin assignment.....	P 4
2. Absolute maximum ratings.....	P 6
3. Electrical characteristics.....	P 6
a. Typical operating conditions.....	P 6
b. Current consumption.....	P 7
c. Front light driving conditions.....	P 7
4. AC timing.....	P 8
a. Timing conditions.....	P 8
b. Timing diagram.....	P 8
c. Display position.....	P 8
d. Display color vs. input data signals.....	P 9
C. Optical specifications	P 10
D. Reliability test items	P 15
E. Display quality	P 15
F. Handling precaution	P 15
G. Packing form	P 16

Appendix:

Fig.1 LCM outline dimensions.....	P17
Fig.2 Timing Diagram (I)	P18
Fig.3 Timing Diagram (II)	P19
Fig.4 Timing Diagram(III)	P20

A. General specifications

NO.	Item	Specification	Remark
1	Driving method	Active matrix TFT	
2	Display mode	Reflective type	
3	Display resolution(pixel)	240 × 3 (H) × 320(V)	
4	Active area(mm)	53.64(H) × 71.52(V)	
5	Screen size(inch)	3.5(Diagonal)	
6	Pixel pitch(mm)	0.2235(H) × 0.2235(V)	
7	Pixel configuration	R. G. B. Vertical stripe	
8	Display color	262144 (colors)	
9	Surface treatment(Touch panel)	(Hard coating 3H)	
10	Interface	18 bits R, G, B digital input	
11	Front light	Single cold-cathode fluorescent lamp for top lighting	
12	Overall dimension(mm)	72.0(W) × 88.45(H) × 4.95(D)	Note 1
13	Bezel opening	56.24(W) × 74.12 (H) (mm)	
14	Weight(g)	50 ± 5	

Note 1: Refer to Fig. 1.

B. Electrical specifications

1.Pin assignment

(1).TFT-LCD panel Input/Output signal interface (Mating connector : FH12-50S-0.5SH)

UR035Q01 Connector Pin Assignment

No	Pin name	I/O	Description
1	XDOFF	I	Gate output disable
2	XDON	I	Gate output enable
3	UD	I	Up/Down control
4	FG	I	Vertical clock
5	STV2	I/O	Vertical start pulse
6	STV1	I/O	Vertical start pulse
7	GND	I	Ground
8	VCC	I	Power
9	VEE	I	Gate low voltage
10	VGG	I	Gate high voltage
11	VCOM	I	Common electrode
12	STH2	I	Horizontal start pulse
13	LR	I	Left/Right control
14	SP	I	Power save control pin
15	B5	I	Blue data (MSB)
16	B4	I	Blue data
17	B3	I	Blue data
18	B2	I	Blue data
19	B1	I	Blue data
20	B0	I	Blue data (LSB)
21	LD	I	Data load signal
22	AVSS	I	Analog ground
23	Vref10	I	Gamma input voltage
24	Vref8	I	Gamma input voltage
25	Vref5	I	Gamma input voltage
26	Vref2	I	Gamma input voltage
27	Vref0	I	Gamma input voltage
28	AVDD	I	Analog power
29	INV	I	EMI reduce function
30	FS	I	Sample clock
31	G5	I	Green data (MSB)
32	G4	I	Green data
33	G3	I	Green data
34	G2	I	Green data
35	G1	I	Green data
36	G0	I	Green data (LSB)
37	GND	I	Ground
38	R5	I	Red data (MSB)
39	R4	I	Red data

40	R3	I	Red data
41	R2	I	Red data
42	R1	I	Red data
43	R0	I	Red data (LSB)
44	DV _{ss}	I	Digital ground
45	STH1	I/O	Horizontal start pulse
46	GND	I	Ground
47	DV _{cc}	I	Digital power
48	AVDD	I	Analog power
49	AVSS	I	Analog ground
50	VCOM	I	Common electrode

Note 1. Selection for horizontal scanning direction

LR	STHL	STHR	Scanning direction(pixel configuration)
High	Output	Input	Normal scanning (1, Y) (240, Y)
Low	Input	Output	Reverse scanning (240, Y) (1, Y)

Note 2. Selection for vertical scanning direction

UD	STVU	STVD	Scanning direction(Pixel configuration)
High	Output	Input	Normal scanning (X, 1) (X, 320)
Low	Input	Output	Reverse scanning(X, 320) (X, 1)

(2) Front light driving section(Connector : JST / BHSR-02VS-1)

Pin No.	Symbol	I/O	Description	Remark
L1	VL1	I	Power supply for fluorescent tube(high voltage)	Pink color wire
L2	VL2	I	Power supply for fluorescent tube(low voltage)	White color wire

Touch panel driving section

Pin No.	Symbol	I/O	Description	Remark
T1	yU	-	Lower electrode Y(12 o' clock side)	
T2	xR	-	Lower electrode X(right side)	
T3	yL	-	Upper electrode Y(6 o' clock side)	
T4	xL	-	Upper electrode X(left side)	

2. Absolute maximum ratings

Item	Symbol	Condition	Min.	Max.	Unit	Remark
Power voltage	DV _{CC}	GND=0	-0.3	5.5	V	
	AV _{DD}	AV _{SS} =0	-0.3	5.5	V	
	V _{GH}	GND=0	-0.3	18	V	
	V _{EE} (V _{GL})		-15	0.3	V	
	V _{GH} - V _{GL}		-	36	V	
Input signal voltage	V _i		-0.3	AV _{DD} +0.3	V	Note 1
	V _I		-0.3	DV _{DD} +0.3	V	Note 2
	V _{COM}		-2.9	5.2	V	
Operating temperature	Topa		-10	50		Ambient temperature
Storage temperature	Tstg		-25	70		Ambient temperature

Note 1: Vrefn (n=0,~4).

Note 2: Rn, Gn, Bn(n=0 ~5), STHL, STHR, XDON,XDOFF, LR, CLK, STVR, STVL, UD, INV,PS,FG

3. Electrical characteristics

a. Typical operating conditions

Item	Symbol	Min.	Typ.	Max.	Unit	Remark
Power supply (Note 3)	DV _{CC}	2.5	3.3	3.6	V	
	AV _{DD}	3.1	3.3	3.6	V	
	V _{GH}	14.3	15	15.7	V	
	V _{GL}	-12.5	-12	-11.5	V	
V _{COM}	V _{CAC}	-	4.8	-	V _{p-p}	Note 1
	V _{CDC}		(0.7)		V	Note 2
Reference voltage	Vref0 ~ Vref10	AV _{SS} +0.1		AV _{DD} -0.1	V	AV _{DD} Vref10 Vref9 Vref8 Vref7 Vref6 Vref5 Vref4 Vref3 Vref2 Vref1 Vref0 AV _{SS}
Input Signal voltage	H Level	V _{IH}	0.8DV _{CC}		V	
	L Level	V _{IL}		0.2DV _{CC}	V	

Note 1: The brightness of LCD panel can be changed by adjusting the AC component of V_{COM}.

Note 2: V_{CDC} could be adjusted so as to minimize vertical straight line, flicker and maximum contrast on each module.

Note 3: Be sure to apply GND, DV_{CC}, V_{GL} to the LCD first, and then apply V_{GH}.

b. Current consumption (GND=AVss=0V)

Parameter	Symbol	Condition	Min.	Typ.	Max.	Unit	Remark
Current for driver	I_{GH}	$V_{GH}=12V$	-	(80)		μA	
	I_{GL}	$V_{GL}=-12V$	-	(-0.2)		mA	
	I_{CC}	$DV_{CC}=3.3V$	-	(1.3)		mA	
	I_{DD}	$AV_{DD}=3.3V$	-	(3.2)		mA	
Current of Vcom	I_{Vcom}	$V_{CAC}=(4.8V)$		0.5		mA	

c. Front light driving conditions

Parameter	Symbol	Min	Typ	Max	Units	Remark
Lamp voltage	V_L	-	(290)	-	Vrms	
Lamp current	I_L	-	1.75	-	mArms	
Frequency	F_L	40	(50)	60	KHz	Note 3
Power consumption	W_L	-	(0.5)	1	W	Note 1
Starting Voltage(T= 0)	V_L			(650)		
Starting Voltage(T= 25)	V_L			(450)		
Minimum ambient light for starting	L	2	-	-	cd/m ²	
Lamp life time	L_L	10,000	-	-	hour	Note 4

Note 1: $T=25$, $I_L=(1.75mArms)$, $V=290$ Vrms

Note 2: Inverter should be designed with the characteristic of lamp. When you are designing the inverter, the output voltage of the inverter should comply with the following conditions.

- (1). The area under the positive and negative cycles of the waveform of the lamp current and lamp voltage should be area symmetric(the symmetric ratio should be larger than 90%).
- (2). There should not be any spikes in the waveform.
- (3). The waveform should be sine wave as possible.
- (4). Lamp current should not exceed the maximum value within the operating Temperature (It is prohibited to over the maximum lamp current even if operated in The non-guaranteed temperature). When lamp current over the maximum value for a long time, it may cause fire. Therefore, it is recommend that the inverter should have the current limited circuit.

Note 3: Lamp frequency may produce interference with horizontal synchronous frequency and this may cause line flow on the display. Therefore lamp frequency shall be detached from the horizontal synchronous frequency and its harmonics as far as possible in order to avoid interference.

Note 4: Brightness ($I_L=2.0mA$) to be decrease to the 50% of the initial value.

4. AC Timing

a. Timing conditions

Parameter	Symbol	Min	Typ	Max	Unit	Remark
Horizontal Timing	Clock frequency	Fclk	-	5.58	7.5	MHz
	Clock width	Tcw	67	-	-	ns
	Setup time of start pulse	Tsu	20	90	-	ns
	Hold time of start pulse	Thd	20	90	-	ns
	Set up time of data	Tdsu	20	90	-	ns
	Hold time of data	Tdhd	20	90	-	ns
	Propogation delay of STH	Tphl	10	-	30	ns
	Frequency of start pulse	Fst	19.8	21.12	23	KHz
	Pulse width of start pulse	Tstw	-	1	-	Tcph
	Time that last data to LD	Tld	-	-	1	Tcph
	Pulse width of LD	Twld	2	-	-	Tcph
	LD signal DIO setup time	Tlds	2	-	-	Tcph
	Pulse width of SP	Twsp	0	-	-	Tcph
	Setup time that POL to LD	Tspl	-	2	-	Tcph
	Hold time that POL to LD	Thpl	-	245	-	Tcph
Vertical Timing	Clock frequency	Fvck	19.8	21.12	23	KHz
	Pulse width of clock	T _{PWCLK}	500	-	-	ns
	Rising time of clock	Trck	-	-	100	ns
	Falling time of clock	Tfck	-	-	100	ns
	Frequency of start pulse	Tvst	-	60	-	Hz
	Setup time of start pulse	Tvsu	50	100	-	ns
	Hold time of start pulse	Tvhd	350	-	-	ns
	Rising time of start pulse	Trvst	-	-	100	ns
	Falling time of start pulse	Tfvst	-	-	100	ns
	Pulse width of GS	Tgs	9	15	-	Tcph
	Period of FG cycle	T4	-	245	-	Tcph

b. Timing diagram

Please refer to the attached drawings, from Fig.2 to Fig.4.

c. Display position

D(1,1)	D(2,1)	D(X,1)	D(239,1)	D(240,1)
D(2,1)	D(2,2)	D(X,2)	D(239,2)	D(240,2)
⋮		⋮	⋮	⋮
D(1,Y)	D(2,Y)	D(X,Y)	D(239,Y)	D(240,Y)
⋮		⋮	⋮	⋮

D(1,319)	D(2,319)	D(X,319)	D(239,319)	D(240,319)
D(1,320)	D(2,320)	D(X,320)	D(239,320)	D(240,320)

d. Display color v.s. input data signals

Display colors		Data signal (0 : Low level, 1: High level)																	
		R5	R4	R3	R2	R1	R0	G5	G4	G3	G2	G1	G0	B5	B4	B3	B2	B1	B0
Basic colors	Black	0	0	0	0	0	0	0	0	0	0	0	0	0	0	0	0	0	0
	Blue	0	0	0	0	0	0	0	0	0	0	0	0	1	1	1	1	1	1
	Red	1	1	1	1	1	1	0	0	0	0	0	0	0	0	0	0	0	0
	Magenta	1	1	1	1	1	1	0	0	0	0	0	0	1	1	1	1	1	1
	Green	0	0	0	0	0	0	1	1	1	1	1	1	0	0	0	0	0	0
	Cyan	0	0	0	0	0	0	1	1	1	1	1	1	1	1	1	1	1	1
	Yellow	1	1	1	1	1	1	1	1	1	1	1	1	0	0	0	0	0	0
	White	1	1	1	1	1	1	1	1	1	1	1	1	1	1	1	1	1	1
Red grayscale	Black	0	0	0	0	0	0	0	0	0	0	0	0	0	0	0	0	0	0
	Dark	0	0	0	0	0	1	0	0	0	0	0	0	0	0	0	0	0	0
	bright																		
			1	1	1	1	0	1	0	0	0	0	0	0	0	0	0	0	0
		1	1	1	1	1	0	0	0	0	0	0	0	0	0	0	0	0	0
	Red	1	1	1	1	1	1	0	0	0	0	0	0	0	0	0	0	0	0
Green grayscale	Black	0	0	0	0	0	0	0	0	0	0	0	0	0	0	0	0	0	0
	Dark	0	0	0	0	0	0	0	0	0	0	0	1	0	0	0	0	0	0
	bright																		
			0	0	0	0	0	0	1	1	1	1	0	1	0	0	0	0	0
		0	0	0	0	0	0	1	1	1	1	1	0	0	0	0	0	0	0
	Green	0	0	0	0	0	0	1	1	1	1	1	1	0	0	0	0	0	0
Blue grayscale	Black	0	0	0	0	0	0	0	0	0	0	0	0	0	0	0	0	0	0
	Dark	0	0	0	0	0	0	0	0	0	0	0	0	0	0	0	0	1	0
	bright																		
			0	0	0	0	0	0	0	0	0	0	0	0	1	1	1	1	0
		0	0	0	0	0	0	0	0	0	0	0	0	1	1	1	1	1	0
	Blue	0	0	0	0	0	0	0	0	0	0	0	0	1	1	1	1	1	1

Note : Each basic color can be displayed in 64 gray scales using the 6 bit data signals. By combining the 18-bit data signals(R, G, B), the 262,144 colors can be achieved on the display.

C. Optical specifications

1. Test conditions

- Ambient temperature : T_a **25±2°C**
- Ambient humidity : H_a **65±20%RH**
- Supply voltage : V_{DD} 3.3V
- Input signal : According to typical value in "Electrical characteristics"
- FL Input current : I_{FL} =1.75mA_{rms}
- FL Driving frequency : f_{FL} = 50kHz
- FL Inverter : (**Harison / HIU-757**)
- Measurement point : One point on the center of panel otherwise specified

The measuring method and systems are shown in 2 and 3. All of characteristics listed are measured under the condition using the Unipac test inverter and photometer. The following items are measured under stable conditions. The optical characteristics should be measured in a dark room (ambient light < 2 lux)

2. Optical specifications (With touch panel, front light and LCD panel)

a. Not driving the front light condition (Note 2)

Item	Symbol	Conditions	Specifications			Unit	Remark
			Min.	Typ.	Max.		
Contrast Ratio	CR_{AVE}	$\theta=0^\circ, \phi=0^\circ$ Viewing normal angle	(12)	(14)		-	System 1 Note 4
Response Time	t_r		-	(15)	20	ms	System 3 Note 3
	t_f		-	(25)	30	ms	
White chromaticity	W_{XOFF}		0.29	0.31	0.33	CIE	System 2
	W_{YOFF}	0.31	0.33	0.35	CIE		
Viewing angle	Horizontal	θ_H	-	(100)	-	Degree	System 1
	Vertical	θ_V	-	(90)	-		
Reflection ratio	R		(15)	21		%	System 1 Note 4

b. Driving the front light condition (Note 1,2,7)

Item	Symbol	Conditions	Specifications			Unit	Note
			Min.	Typ.	Max.		
Contrast Ratio	CR_{AVE}	$\theta=0^\circ, \phi=0^\circ$ Viewing normal angle	(8)	(9)	-	-	System 1 Note 4
White chromaticity	W_{XON}		(0.28)	(0.31)	(0.34)	CIE	System 2
	W_{YON}		(0.29)	(0.32)	(0.35)	CIE	
Luminance	Y_L		(24)	(30)	-	cd/m ²	System 4
White uniformity	δ_W		-	(1.3)	(1.5)	-	System 4, Note 6,8

Note 1: To be measured in dark room after lighting the frontlight for 30 minutes.

Note 2: To be measured with a field angle of 1 ° by Topcon luminance meter BM-7.

Note 3: Definition of response time:

The output signals of BM-7 are measured when the input signals are changed from “Black” to “White” (falling time) then from “White” to “Black” (rising time), respectively. The response time means the interval between the 10% and 90% of amplitudes. Refer to figure as below.

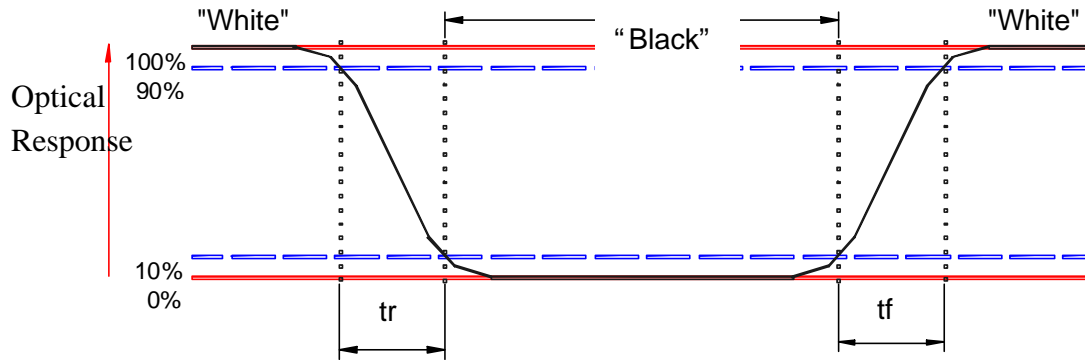

Note 4. Definition of contrast ratio:

The contrast ratio can be calculated by the following expression.

$$\text{Contrast Ratio (CR)} = L63 / L0$$

L63: Luminance on the white raster (gray scale level L63)

L 0: Luminance on the black raster (gray scale level L0)

Note 5: Definition of viewing angle:

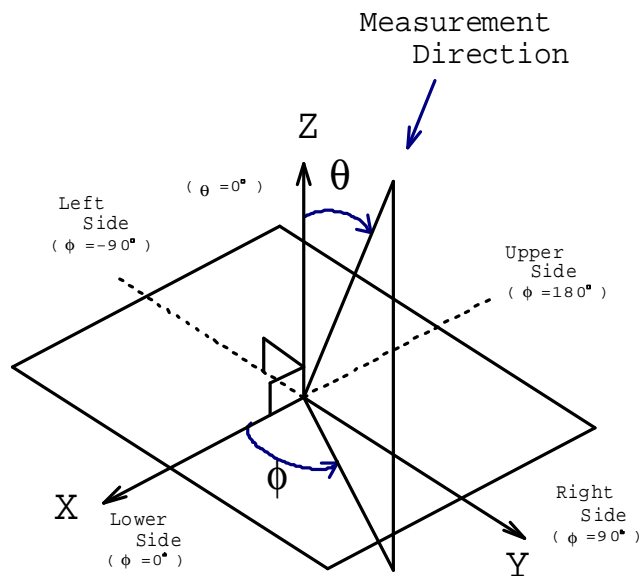

Note 6: Definition of white uniformity:

$$\delta_w = \frac{\text{Maximum Luminance of nine points (brightness)}}{\text{Minimum Luminance of nine points (brightness)}}$$

Definition of the 9 points (from 1 to 9) on panel, refer to figure as below

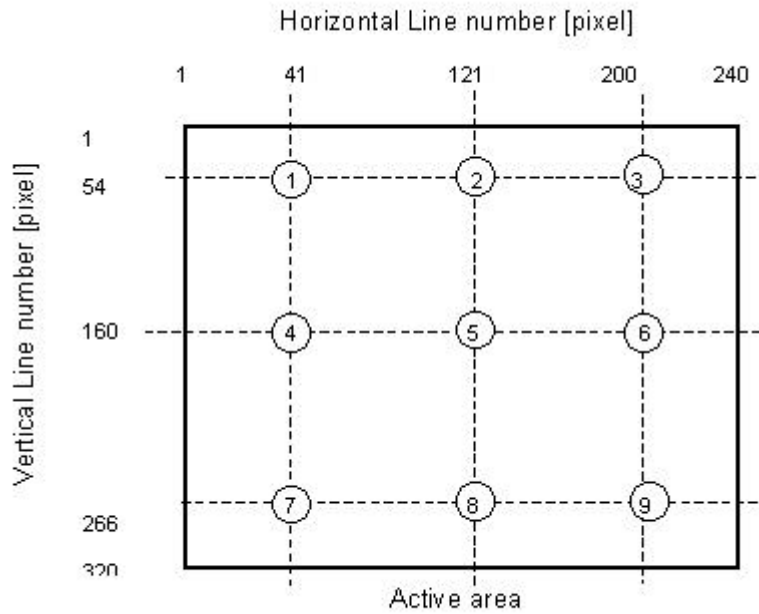

Note 7: Driving conditions for CCFL : $I_L=1.75$ mA, 50KHz Frequency

3.Measurement system:

a. System 1

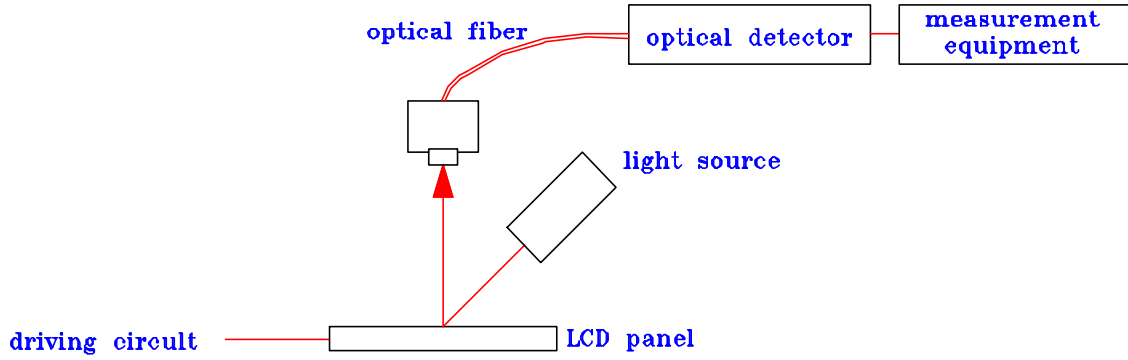

b. System 2

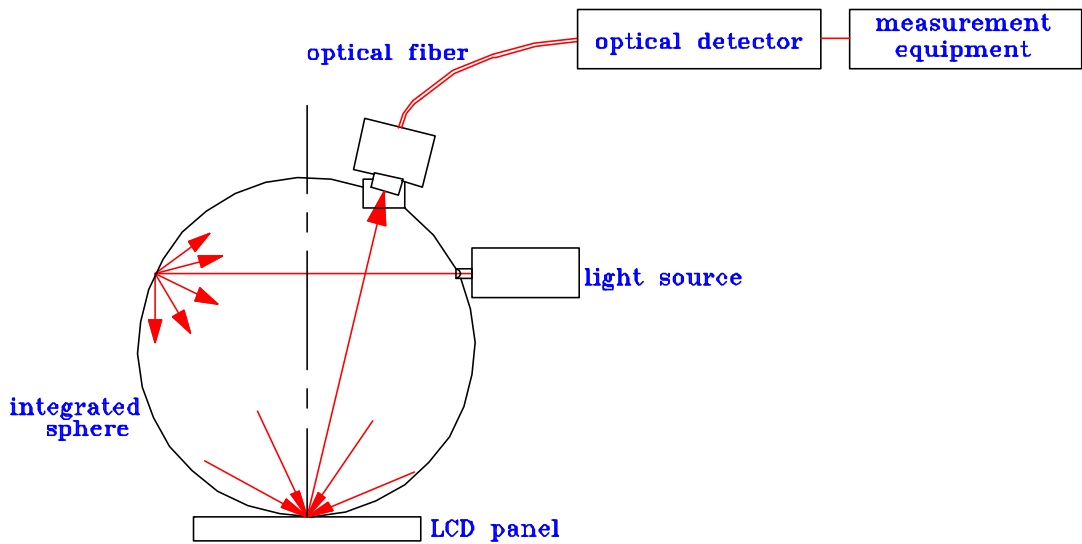

c. System 3

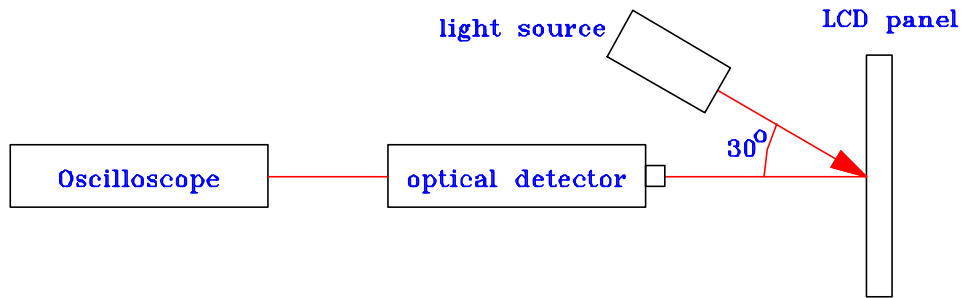

d. System 4

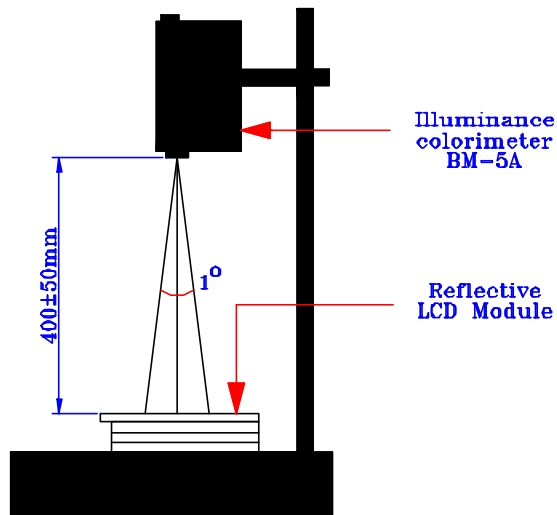

(a) The apparatus for Luminance measurement

D. Reliability test items (Note 1)

No.	Test items	Test conditions
1	High temperature storage test	Ta= 70 , 240 Hrs
2	Low temperature storage test	Ta= -25 , 240 Hrs
3	High temperature and high humidity operating test	Ta= 40 , 90%RH, 240 Hrs(no condensation of dew)
4	High temperature operating test	Ta= 50 , 240 Hrs
5	Low temperature operating test	Ta= -10 , 240 Hrs
6	Heat shock test	Ta= -25 (1H) ~ 70 (1H) /5cycles
7	Altitude storage test	Height = 0 ~ 40000 feet,48hr
8	Altitude operating test	Height = 0 ~ 15000 feet,48hr
9	Vibration test	Frequency: 10Hz ~ 55Hz Stroke: 1.5mm Sweep: 10Hz ~ 55Hz X,Y,Z 2hours for each direction(total 6hours)
10	Shock test	100G, 6ms ± X, ± Y, ± Z 3 times for each direction
11	Electro static discharge test	± 200V, 200pF(0), 1 time for each terminal
12	Electro static discharge test(Air)	Discharge = ± 8 KV,Contact = ± 4 KV (10times/1point,1times/1sec)
13	Point activation test(touch panel)	Hit it 1,000,000 times with silicon rubber of R8 H60 Hitting force: 250g Hitting speed: 3 times per second

Note 1: Evaluation should be tested after storage at room temperature for one hour.

Note 2: There should be no change which might affect the practical display function when the display quality test is conducted under normal operating condition.

Note 3: Judgement: 1. Function OK

2. No serious image quality degradation

E. Display quality

The display quality of the color TFT-LCD module should be in compliance with the Unipac' s OQC inspection standard.

F. Handling precaution

The Handling of the TFT-LCD should be in compliance with the Unipac' s handling principle standard.



Spec. No. : 413-212-112
Dco.Version : 3
Page : 16/20

G. Packing form :

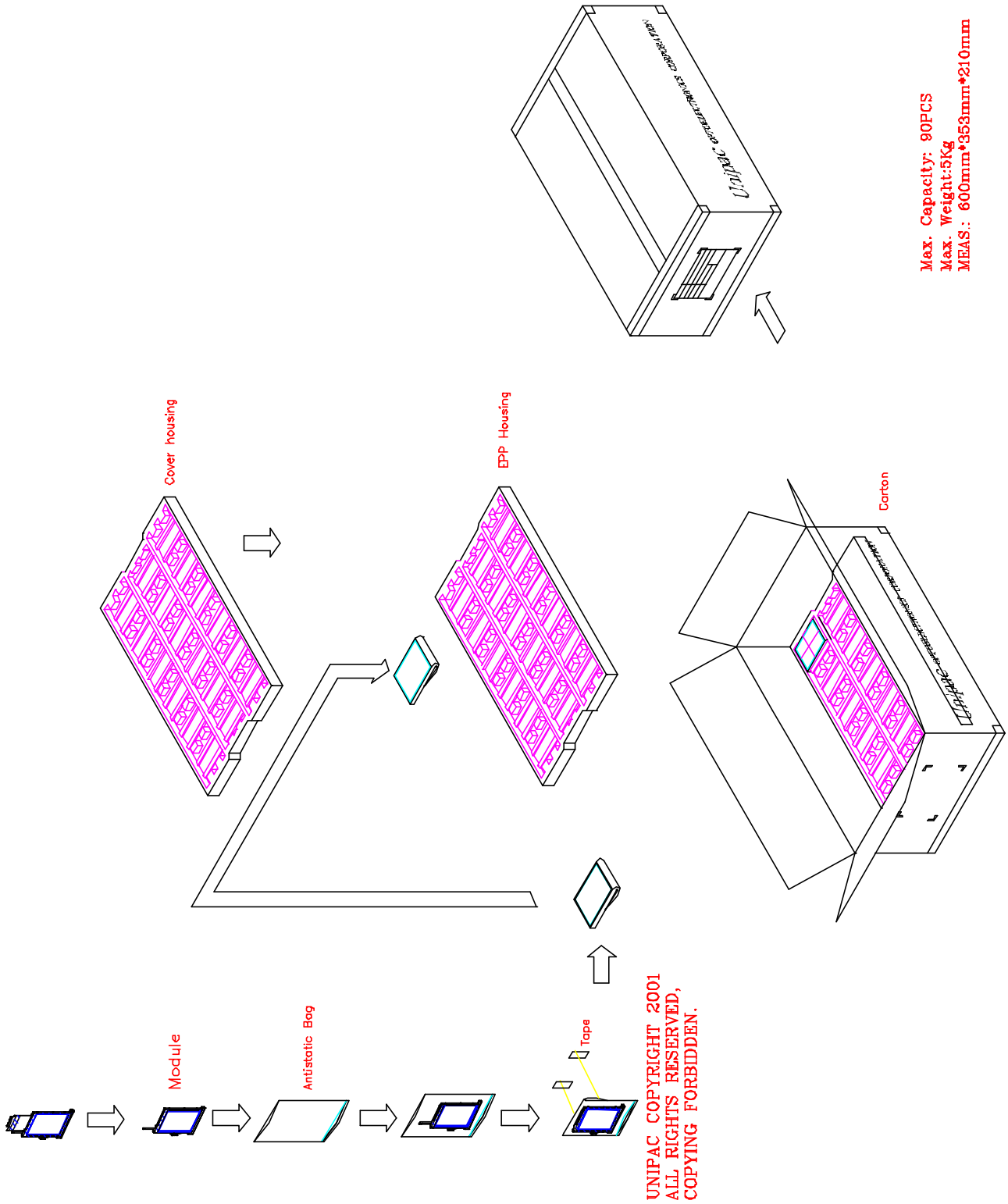

AC Characteristics

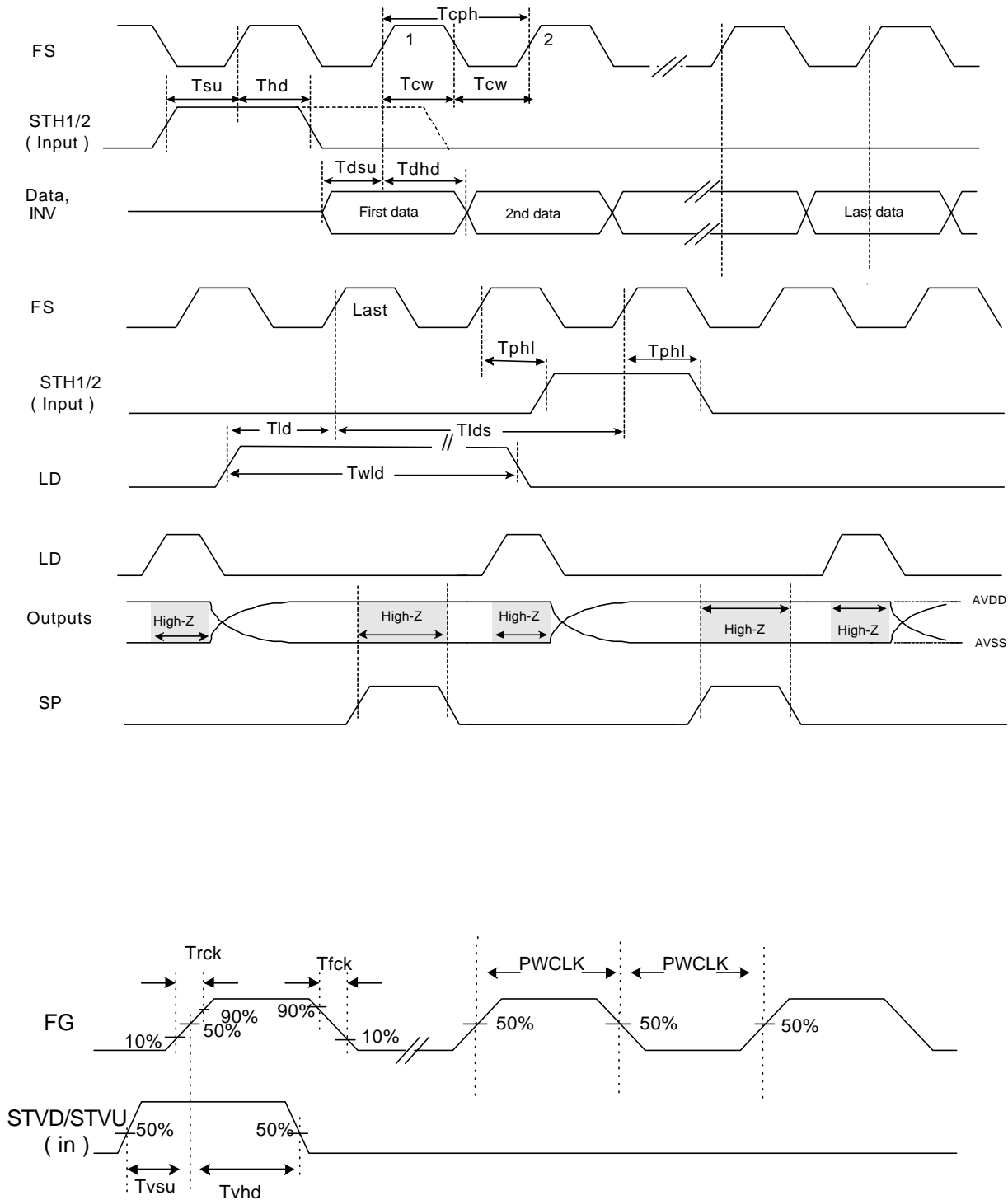

Fig.2 Timing Diagram(I)

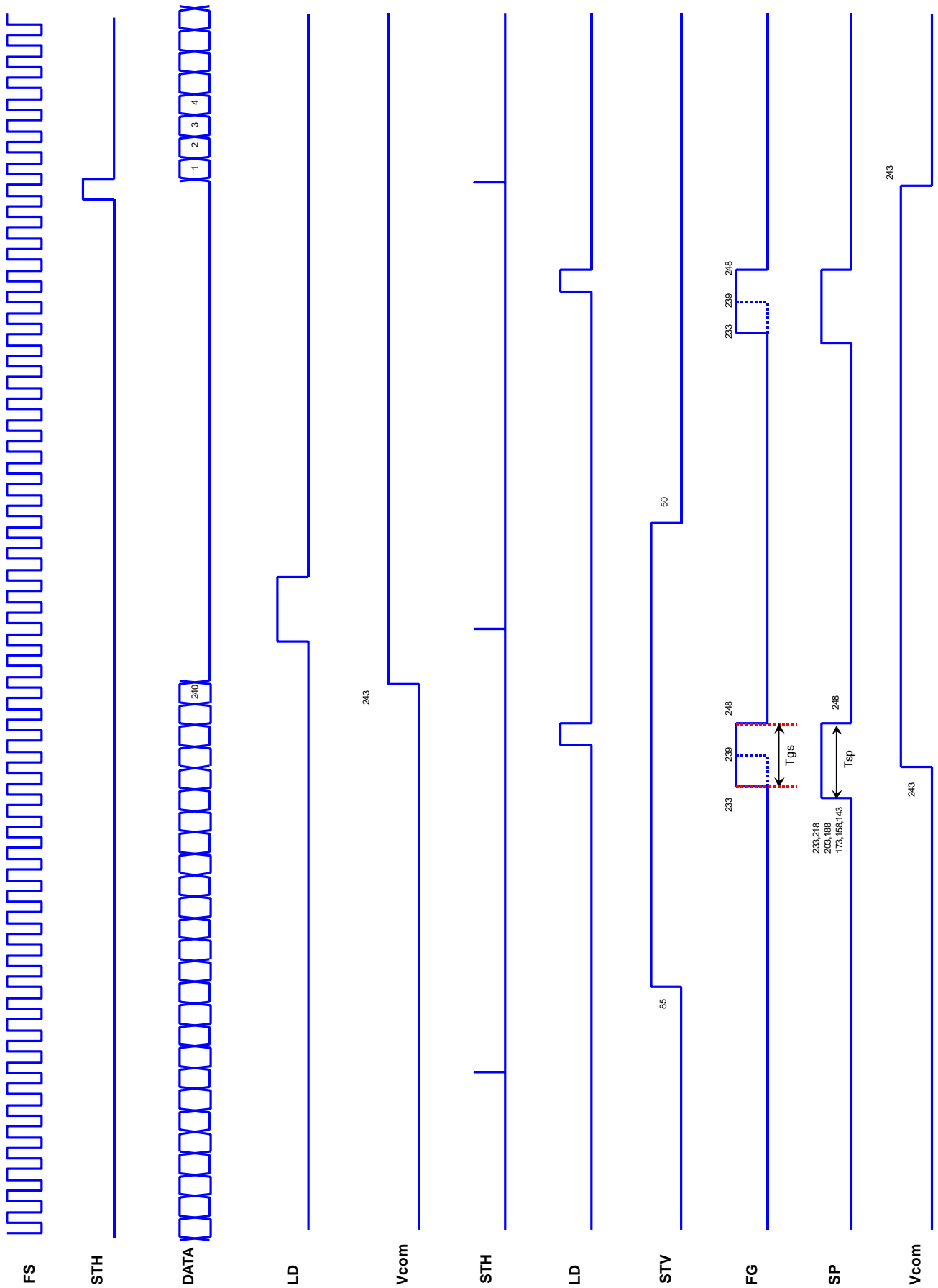

Fig.3 Timing Diagram(II)

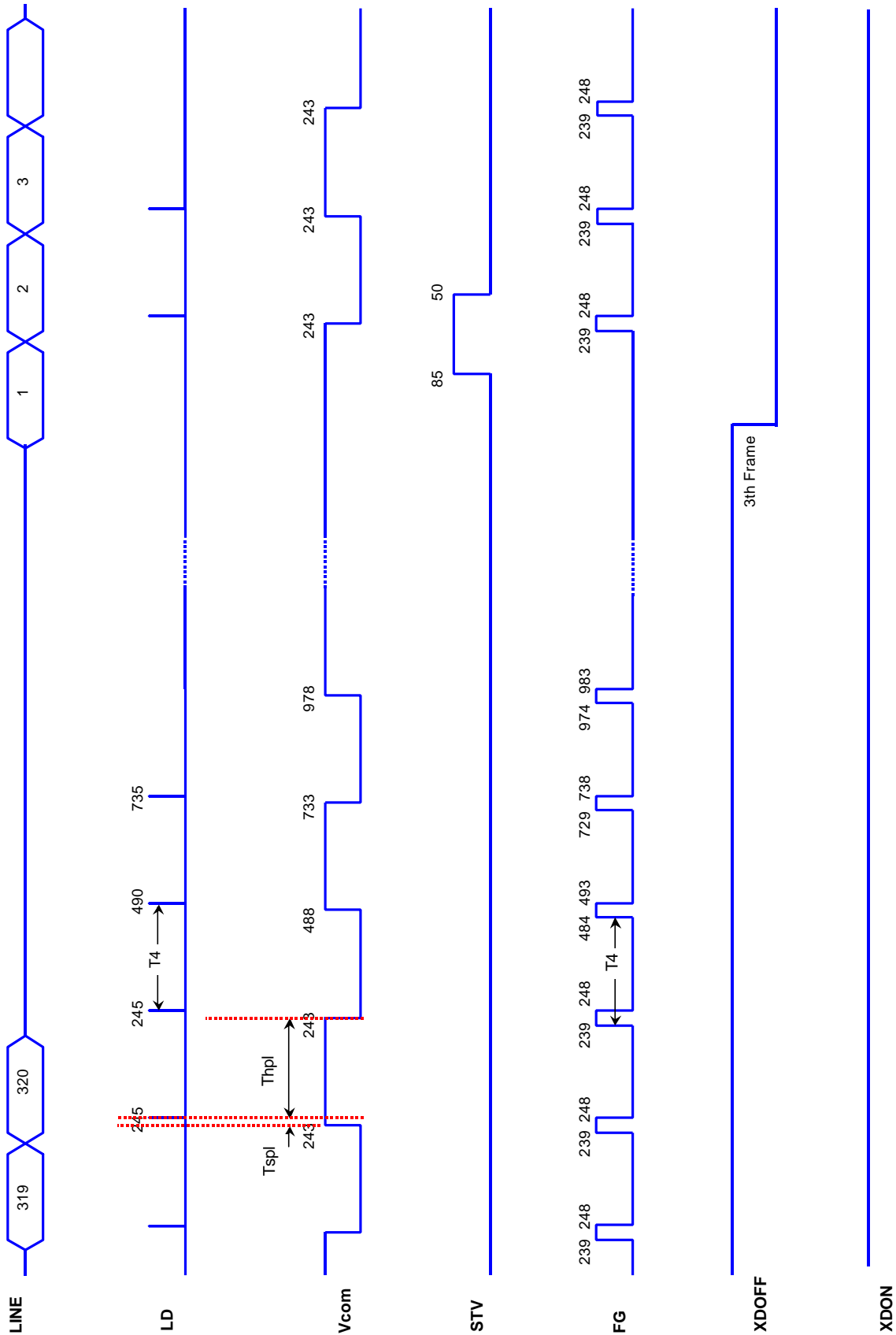

Fig.4 Timing Diagram(III)