

## POWER DIODE MODULE

### Features

- All the terminals and the mounting plate are electrically isolated. These modules can be installed in the same cooling fin as other modules, thus saving installation space – a cost-effective feature.
- The diode chips are coated with a glass of zinc oxide, making them highly resistant to temperature and humidity variation.
- Two diode chips are connected in series internally, so allowing the rectifying circuit to be simplified.

### Applications

- Inverters for AC motors
- Power supply units for DC motors
- DC power supply units for battery chargers
- General purpose DC power supply units

### Outline Drawings

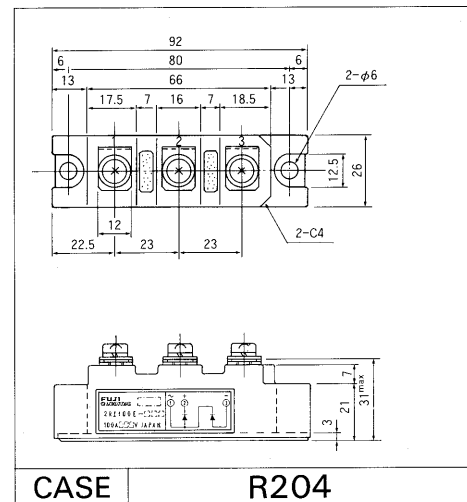

### Inner Circuit Schematic

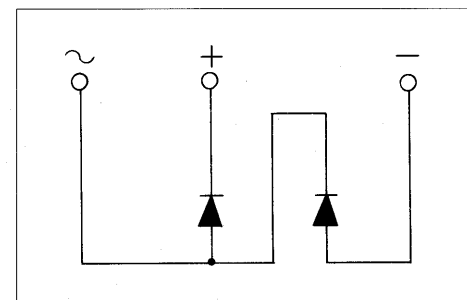

## Maximum Ratings and Characteristics

### Absolute Maximum Ratings

Items	Symbols	Conditions	2RI100E		Units
			-060	-080	
Repetitive peak reverse voltage	$V_{RRM}$		600	800	V
Non-repetitive peak reverse voltage	$V_{RSM}$		660	880	V
Average forward current	$I_{F(AV)}$	50/60 Hz Sinewave, $T_C = 103^\circ\text{C}$	2 × 100		A
Surge current	$I_{FSM}$	Rated load conditions	2000		A
$I_t^2$	$I_t^2$	Rated load conditions	16000		A <sup>2</sup> s
Junction temperature	$T_j$		-40 ~ +150		°C
Storage temperature	$T_{stg}$		-40 ~ +150		°C
Tightening torque		Mounting screw: M5	25 ± 5		kg·cm
Vibration resistance			5		G
Dielectric strength		Between terminals and base	2000 VAC 1min		
Net. Weight			180		g

### Electrical Characteristics

Items	Symbols	Conditions	Min	Typ	Max	Units
Forward voltage	$V_{FM}$	$T_j = 25^\circ\text{C}$ , $I_{FM} = 320\text{ A}$			1.30	V
Reverse current	$I_{RRM}$	$T_j = 150^\circ\text{C}$ , $V_R = V_{RRM}$			20	mA

### Thermal Characteristics

Items	Symbols	Conditions	Min	Typ	Max	Units
Thermal resistance (Junction to case)	$R_{th(j-c)}$	50/60 Hz Sinewave, Thermal resistance for total loss			0.20	°C/W
Thermal resistance	$R_{th(c-f)}$	With thermal compound			0.10	°C/W

■ Characteristic curves

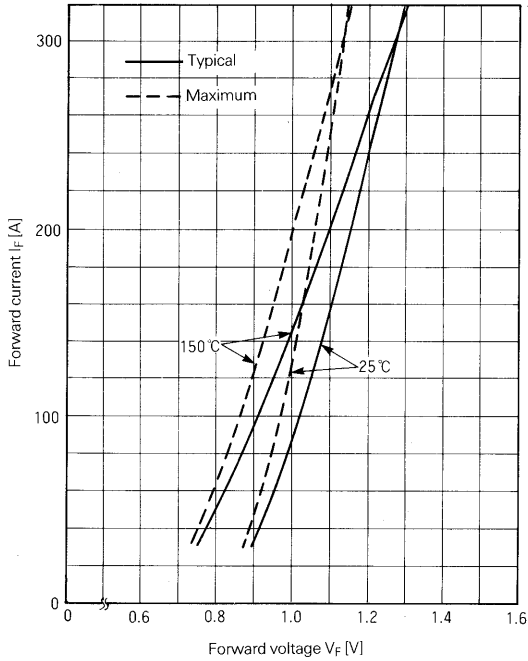

Forward Characteristics

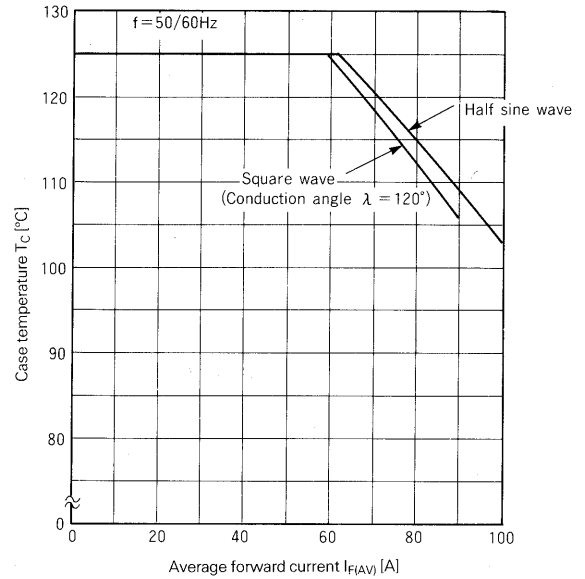

Case Temperature — Forward Average Current

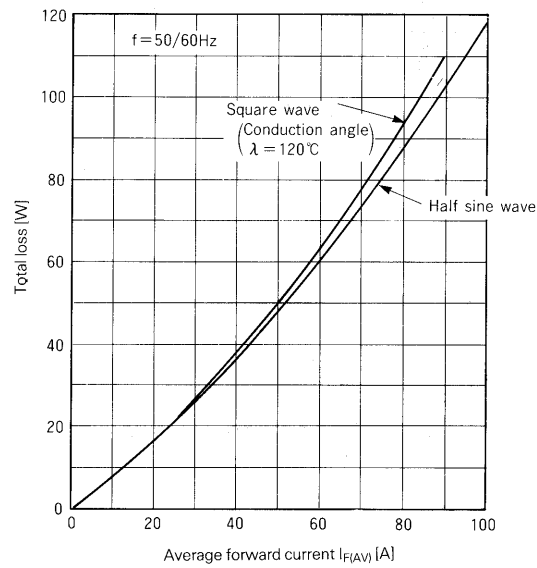

Power Loss — Forward Average Current

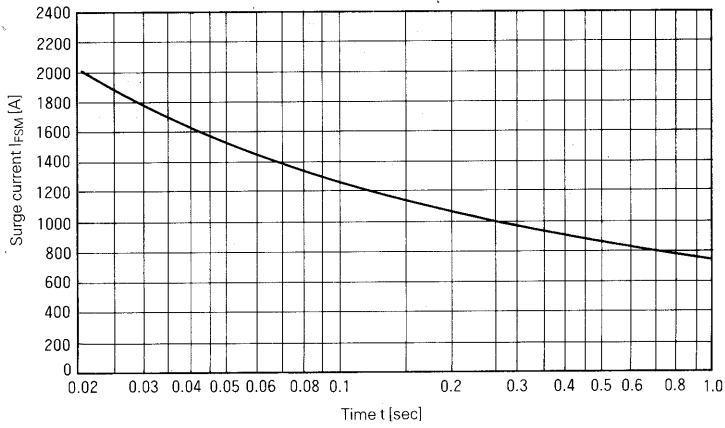

Surge Current

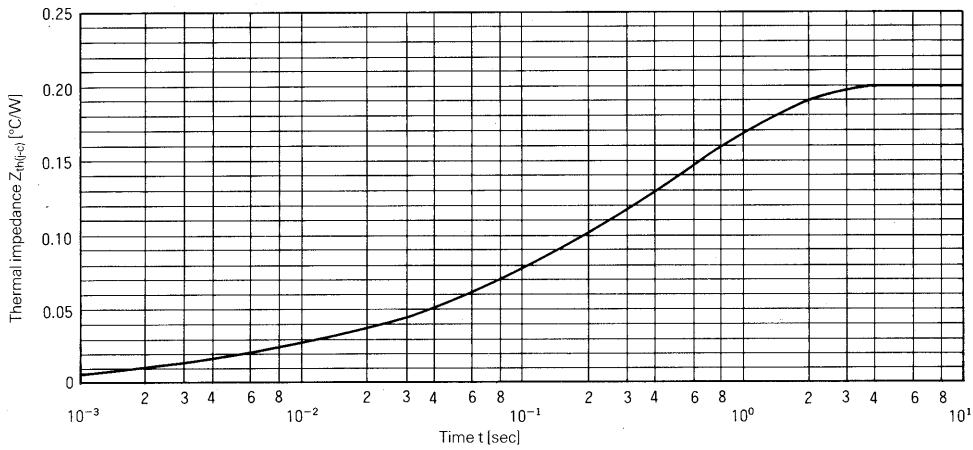

Transient Thermal Impedance

For more information, contact:

**Collmer Semiconductor, Inc.**

P.O. Box 702708

Dallas, TX 75370

972-733-1700

972-381-9991 Fax

<http://www.collmer.com>

This datasheet has been download from:

[www.datasheetcatalog.com](http://www.datasheetcatalog.com)

Datasheets for electronics components.