

High-Beta Single Darlington Transistor Module 500 Amperes/600 Volts

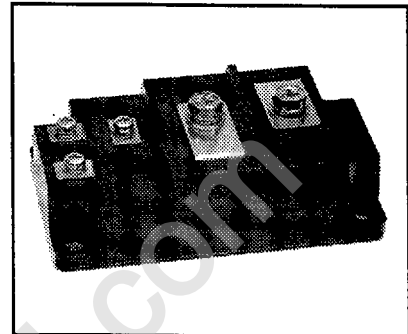
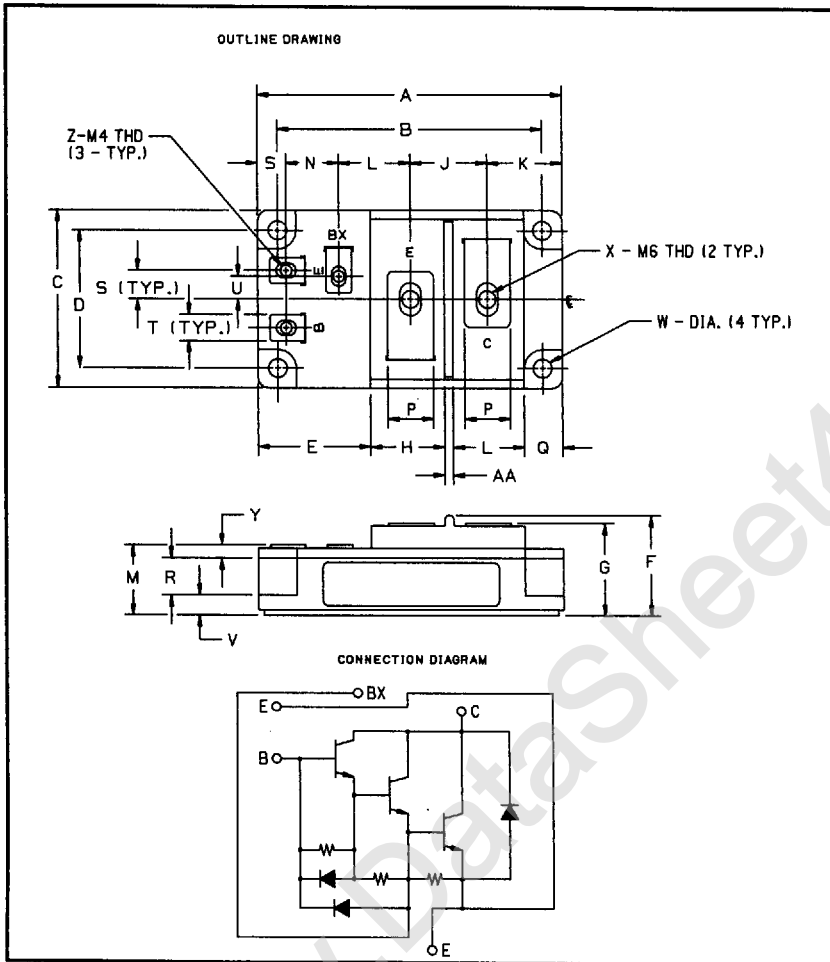

Description:

The Powerex High-Beta Single Darlington Transistor Modules are high power devices designed for use in switching applications. The modules are isolated, consisting of one Darlington Transistor with a reverse parallel connected high-speed diode and base-to-emitter speed-up diode.

Features:

- Isolated Mounting
- Planar Chips
- Discrete Fast Recovery Feedback Diode
- High Gain (h_{FE})
- Base-Emitter Speed-up Diode

Applications:

- Inverters
- DC Motor Control
- Switching Power Supplies
- AC Motor Control

Ordering Information:

Example: Select the complete eight digit module part number you desire from the table - i.e. KS624550 is a 450 V_{CEO(sus)} (600 V_{CEV}), 500 Ampere High-Beta Single Darlington Module.

Type	V _{CEO(sus)} Volts (X 10)	Current Rating Amperes (X 10)
KS62	45	50

Outline Drawing

Dimensions	Inches	Millimeters
A	4.212	107
B	3.661	93
C	2.441	62
D	1.890 ± 0.010	48 ± 0.25
E	1.476	37.5
F	1.378 Max.	35 Max.
G	1.268	32.2
H	1.102	28
J	1.063	27
K	1.043	26.5
L	0.984	25
M	0.964	24.5
N	0.728	18.5

Dimensions	Inches	Millimeters
P	0.630	16
Q	0.531	13.5
R	0.512	13
S	0.394	10
T	0.354	9
U	0.315	8
V	0.276	7
W	0.256 Dia.	6.5 Dia.
X	M6 Metric	M6
Y	0.177	4.5
Z	M4 Metric	M4
AA	0.118	3



Powerex, Inc., 200 Hillis Street, Youngwood, Pennsylvania 15697-1800 (412) 925-7272

KS624550
High-Beta Single Darlington Transistor Module
 500 Amperes/600 Volts

Absolute Maximum Ratings, $T_j = 25\text{ }^\circ\text{C}$ unless otherwise specified

Ratings	Symbol	KS624550	Units
Junction Temperature	T_j	-40 to 150	$^\circ\text{C}$
Storage Temperature	T_{stg}	-40 to 125	$^\circ\text{C}$
Collector-Emitter Sustaining Voltage	$V_{CEO(sus)}$	450	Volts
Collector-Emitter Sustaining Voltage, $V_{BE} = -2\text{V}$	$V_{CEV(sus)}$	600	Volts
Collector-Base Voltage	V_{CBO}	600	Volts
Emitter-Base Voltage	V_{EBO}	7	Volts
Collector-Emitter Voltage	V_{CEV}	600	Volts
Continuous Collector Current	I_C	500	Amperes
Diode Forward Current	I_{FM}	500	Amperes
Continuous Base Current	I_B	10	Amperes
Diode Surge Current	I_{FSM}	5000	Amperes
Power Dissipation	P_t	1780	Watts
Max. Mounting Torque M6 Terminal Screws (E, C)	-	26	in.-lb.
Max. Mounting Torque M4 Terminal Screws (B, Bx, E)	-	12	in.-lb.
Max. Mounting Torque M6 Mounting Screws	-	26	in.-lb.
Modular Weight (Typical)	-	6400	Grams
V Isolation	V_{RMS}	2500	Volts

Electrical Characteristics, $T_j = 25\text{ }^\circ\text{C}$ unless otherwise specified

Characteristics	Symbol	Test Conditions	Min.	Typ.	Max.	Units	
Collector Cutoff Current	I_{CEV}	$V_{CE} = 600\text{V}, V_{BE} = -2\text{V}$	-	-	5	mA	
Emitter Cutoff Current	I_{EBO}	$V_{EB} = 7\text{V}$	-	-	500	mA	
DC Current Gain	h_{FE}	$I_C = 500\text{A}, V_{CE} = 2.5\text{V}$	75	-	-	-	
Diode Forward Voltage	V_{FM}	$I_{FM} = 500\text{A}$	-	-	1.8	Volts	
Collector-Emitter Saturation Voltage	$V_{CE(sat)}$	$I_C = 500\text{A}, I_B = 0.67\text{A}$	-	-	2.5	Volts	
Base-Emitter Saturation Voltage	$V_{BE(sat)}$	$I_C = 500\text{A}, I_B = 0.67\text{A}$	-	-	3.5	Volts	
Resistive	Turn-on	t_{on}	$V_{CC} = 300\text{V}$	-	-	3.0	μs
Load	Storage Time	t_s	$I_C = 500\text{A}$	-	-	10	μs
Switch Times	Fall Time	t_f	$I_{B1} = 1\text{A}, I_{B2} = -10\text{A}$	-	-	3.5	μs

Thermal and Mechanical Characteristics, $T_j = 25\text{ }^\circ\text{C}$ unless otherwise specified

Characteristics	Symbol	Test Conditions	Min.	Typ.	Max.	Units
Thermal Resistance, Case-to-Sink	$R_{\theta(c-s)}$	-	-	-	0.04	$^\circ\text{C/W}$
Thermal Resistance, Junction-to-Case	$R_{\theta(j-c)}$	Transistor Part	-	-	0.07	$^\circ\text{C/W}$
Thermal Resistance, Junction-to-Case	$R_{\theta(j-c)}$	Diode Part	-	-	0.25	$^\circ\text{C/W}$

KS624550
High-Beta Single Darlington Transistor Module
 500 Amperes/600 Volts

DC CURRENT GAIN (TYPICAL)

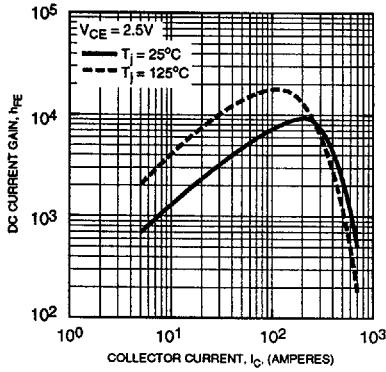

SATURATION VOLTAGE (TYPICAL)

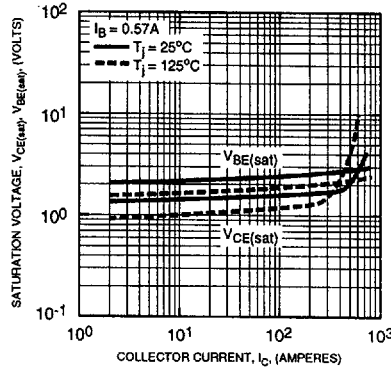

COMMON EMITTER OUTPUT CHARACTERISTICS (TYPICAL)

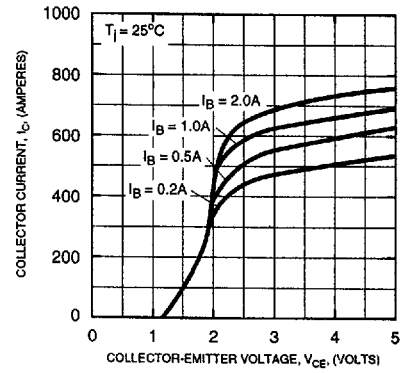

COMMON EMITTER INPUT CHARACTERISTICS (TYPICAL)

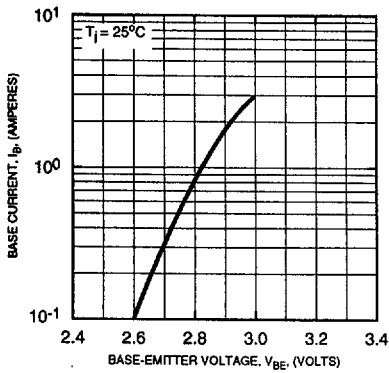

SWITCHING CHARACTERISTICS (TYPICAL)

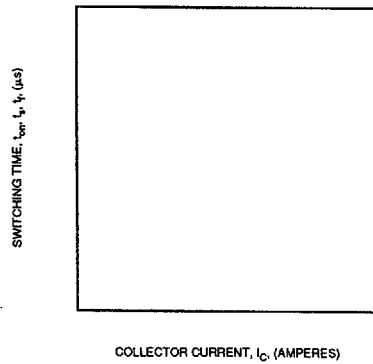

COLLECTOR-EMITTER SATURATION VOLTAGE (TYPICAL)

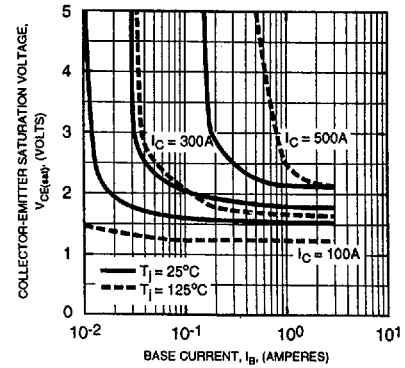

SWITCHING TIME VS. BASE CURRENT (TYPICAL)

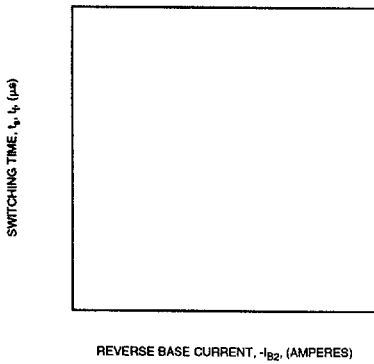

DIODE CHARACTERISTICS (TYPICAL)

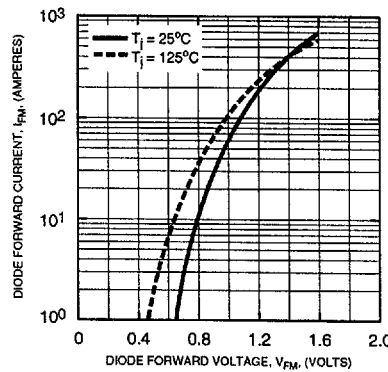

REVERSE BIAS SAFE OPERATING AREA (RBSOA)

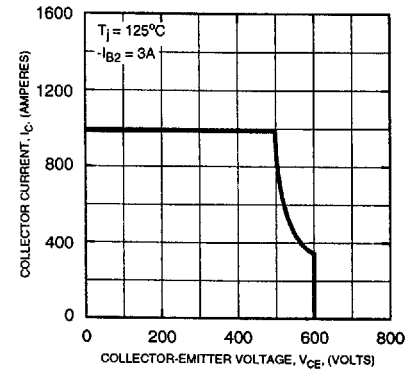

KS624550
High-Beta Single Darlington Transistor Module
500 Amperes/600 Volts

FORWARD BIAS SAFE OPERATING AREA (SOA)

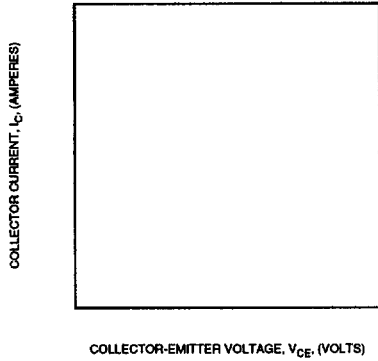

DERATING FACTOR OF SAFE OPERATING AREA (SOA)

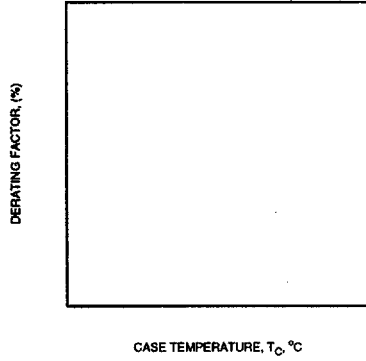

REVERSE RECOVERY CHARACTERISTICS OF FREE-WHEEL DIODE (TYPICAL)

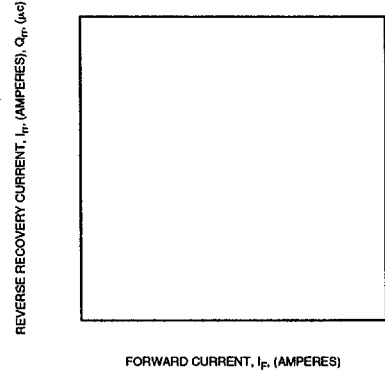

DIODE FORWARD SURGE CURRENT

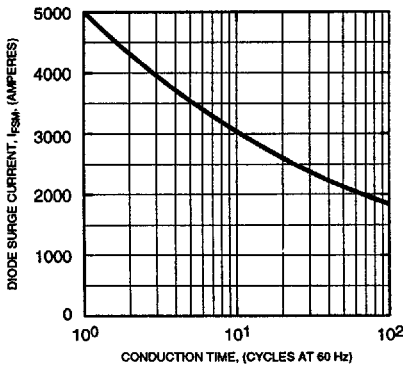

TRANSIENT THERMAL IMPEDANCE CHARACTERISTICS (TRANSISTOR)

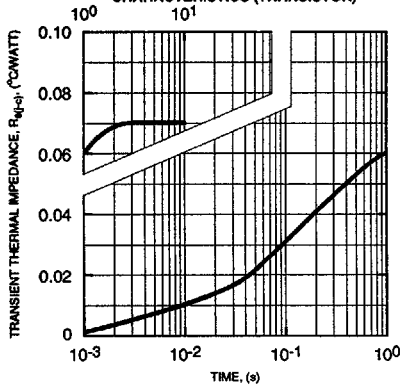

TRANSIENT THERMAL IMPEDANCE CHARACTERISTICS (DIODE)

