

ASSP For Power Management Applications (Mobile Phones)

Power Management IC for Mobile Phone

MB3892

■ DESCRIPTION

MB3892 is a low-saturation voltage type series regulator contains 3 channels for the baseband regulator, 1 channel for the backup regulator, 6 channels for the RF regulator, and 1 channel for the variable regulator. MB3892 is built in reset circuit, serial control circuit, operation Amp. for charge control of Lithium ion battery, LED drive circuit, receiver Amp., loudspeaker drive Amp., sounder circuit, vibrator drive circuit, and 4-ch D/A converter and the devices is miniaturized by systematization of built-in power supply for mobile phone.

■ FEATURES

- Power supply voltage range : VB = 2.85 V to 5.5 V
: EXTVCC = 3.0 V to 6.5 V
- Low power consumption current during standby : 100 μ A (Max.)
- Built-in low-saturation voltage type series regulator
- Built-in power-on reset function
- Built-in serial control function
- Built-in operation Amp. for charge control of Lithium ion battery
- Special power off function
(To prevent battery discharge, this function controls the power consumption current of main IC under 11 μ A (typ.) on the shipment.)

■ PACKAGE

80-pin plastic LQFP

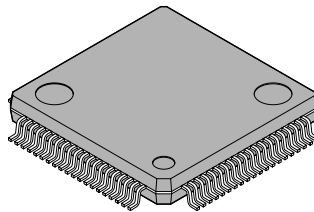

(FPT-80P-M17)

■ PIN ASSIGNMENT

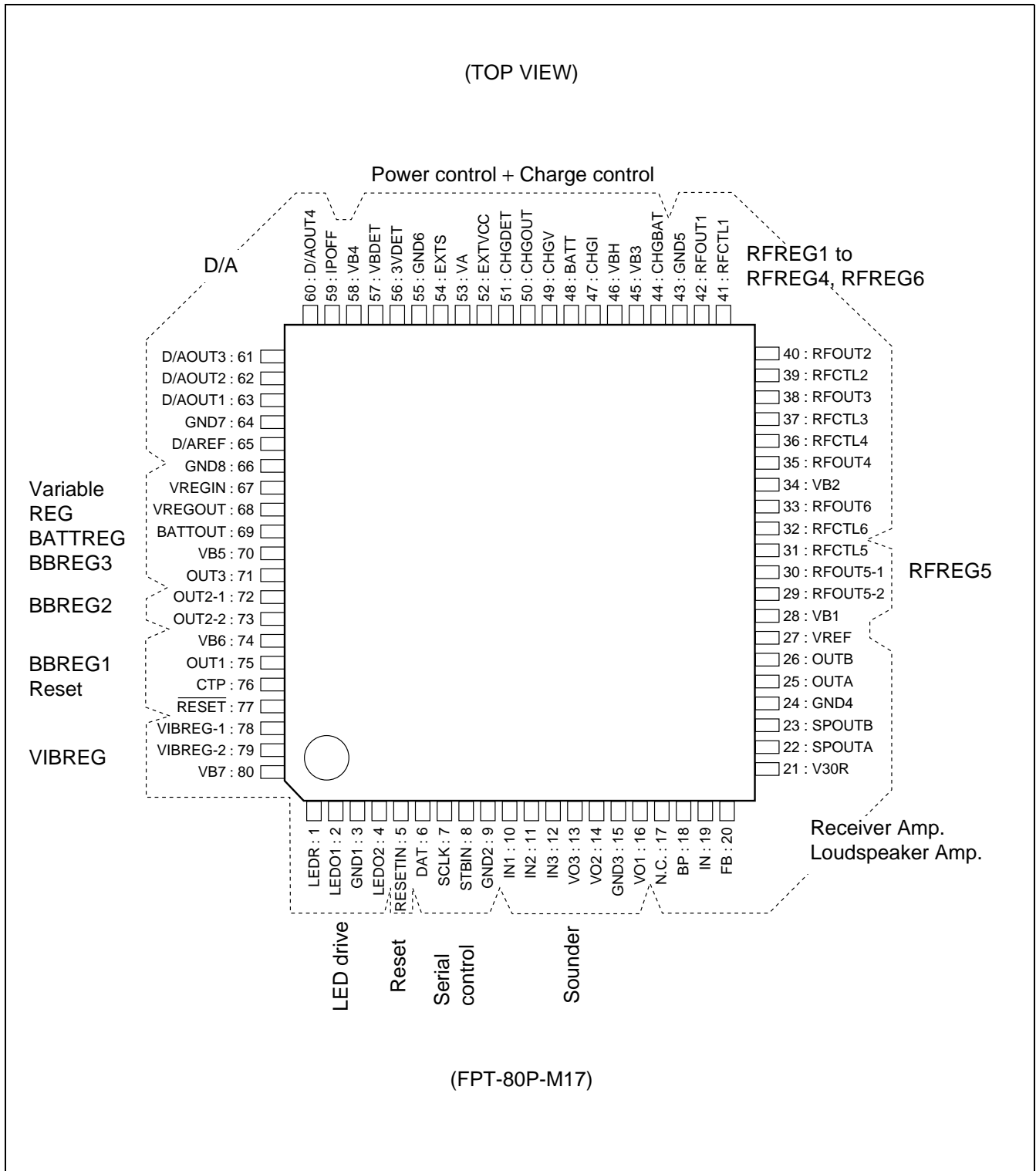

■ PIN DESCRIPTION

Pin No.	Symbol	I/O	Descriptions
1	LEDR	O	LEDR output pin. (an open collector output)
2	LEDO1	O	LED1 output pin. (an open drain output)
3	GND1	—	Ground pin.
4	LEDO2	O	LED2 output pin. (an open drain output)
5	RESETIN	I	Reset detect comparator input pin.
6	DAT	I	Serial data input pin.
7	SCLK	I	Serial clock input pin.
8	STBIN	I	Strobe input pin.
9	GND2	—	Ground pin.
10	IN1	I	Sounder1 control input pin.
11	IN2	I	Sounder2 control input pin.
12	IN3	I	Sounder3 control input pin.
13	VO3	O	Sounder3 control output pin. (an open drain output)
14	VO2	O	Sounder2 control output pin. (an open drain output)
15	GND3	—	Ground pin.
16	VO1	O	Sounder1 control output pin. (an open drain output)
17	N.C.	—	No connection pin.
18	BP	—	Bypass pin.
19	IN	I	Non-inverted input pin.
20	FB	I	Inverted input pin.
21	V30R	—	Power supply pin for speaker Amp.
22	SPOUTA	O	Output A pin for loudspeaker Amp.
23	SPOUTB	O	Output B pin for loudspeaker Amp.
24	GND4	—	Ground pin.
25	OUTA	O	Output A pin for receiver Amp.
26	OUTB	O	Output B pin for receiver Amp.
27	VREF	O	Reference output voltage pin.
28	VB1	—	Power supply pin.
29	RFOUT5-2	O	RF REG5 output pin2. (Short circuiting to pin 30)
30	RFOUT5-1	O	RF REG5 output pin1. (Short circuiting to pin 29)
31	RFCTL5	I	RF REG5 control pin.
32	RFCTL6	I	RF REG6 control pin.
33	RFOUT6	O	RF REG6 output pin.
34	VB2	—	Power supply pin.

(Continued)

MB3892

Pin No.	Symbol	I/O	Descriptions
35	RFOUT4	O	RF REG4 output pin.
36	RFCTL4	I	RF REG4 output pin.
37	RFCTL3	I	RF REG3 control pin.
38	RFOUT3	O	RF REG3 output pin.
39	RFCTL2	I	RF REG2 control pin.
40	RFOUT2	O	RF REG2 output pin.
41	RFCTL1	I	RF REG1 control pin.
42	RFOUT1	O	RF REG1 output pin.
43	GND5	—	Ground pin.
44	CHGBAT	—	Main charge pin.
45	VB3	—	Power supply pin.
46	VBH	I	Main charge pin.
47	CHGI	O	Main charge pin.
48	BATT	O	A/D input pin.
49	CHGV	I	Main charge pin.
50	CHGOUT	O	Main charge pin.
51	CHGDET	O	Main charge pin.
52	EXTVCC	—	Power supply pin for charge control.
53	VA	I	Preliminary charge pin.
54	EXTS	O	Preliminary charge pin.
55	GND6	—	Ground pin.
56	3VDET	O	Power supply detector pin.
57	VBDET	I	Power supply detector pin.
58	VB4	—	Power supply pin.
59	IPOFF	I	Special power off input pin.
60	D/AOUT4	O	10 bit D/A output pin.
61	D/AOUT3	O	8 bit D/A3 output pin.
62	D/AOUT2	O	8 bit D/A2 output pin.
63	D/AOUT1	O	8 bit D/A1 output pin.
64	GND7	—	Ground pin.
65	D/AREF	I	D/A reference voltage input pin.
66	GND8	—	Ground pin.
67	VREGIN	I	Variable REG reference voltage input pin.
68	VREGOUT	O	Variable REG output pin.

(Continued)

(Continued)

Pin No.	Symbol	I/O	Descriptions
69	BATTOUT	O	Backup REG output pin.
70	VB5	—	Power supply pin.
71	OUT3	O	Baseband REG3 output pin.
72	OUT2-1	O	Baseband REG2 output pin. (Short circuiting to pin 73)
73	OUT2-2	O	Baseband REG2 output pin. (Short circuiting to pin 72)
74	VB6	—	Power supply pin.
75	OUT1	O	Baseband REG1 output pin.
76	CTP	I	Setting pin for power-on reset hold time.
77	$\overline{\text{RESET}}$	O	Reset output pin.
78	VIBREG-1	O	Vibrator REG output pin. (Short circuiting to pin 79)
79	VIBREG-2	O	Vibrator REG output pin. (Short circuiting to pin 78)
80	VB7	—	Power supply pin.

■ BLOCK DIAGRAM (General)

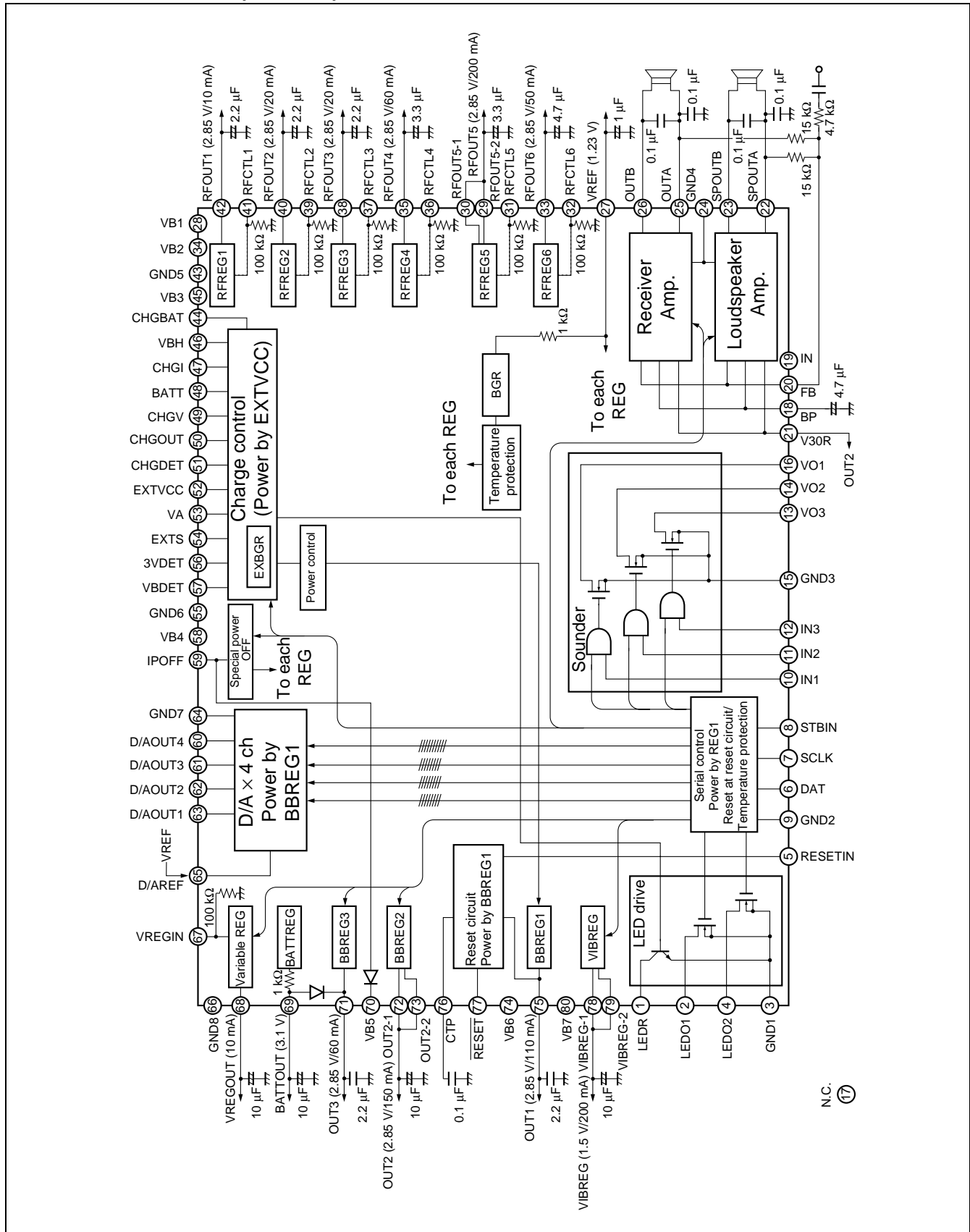

N.C. (17)

• Charge control

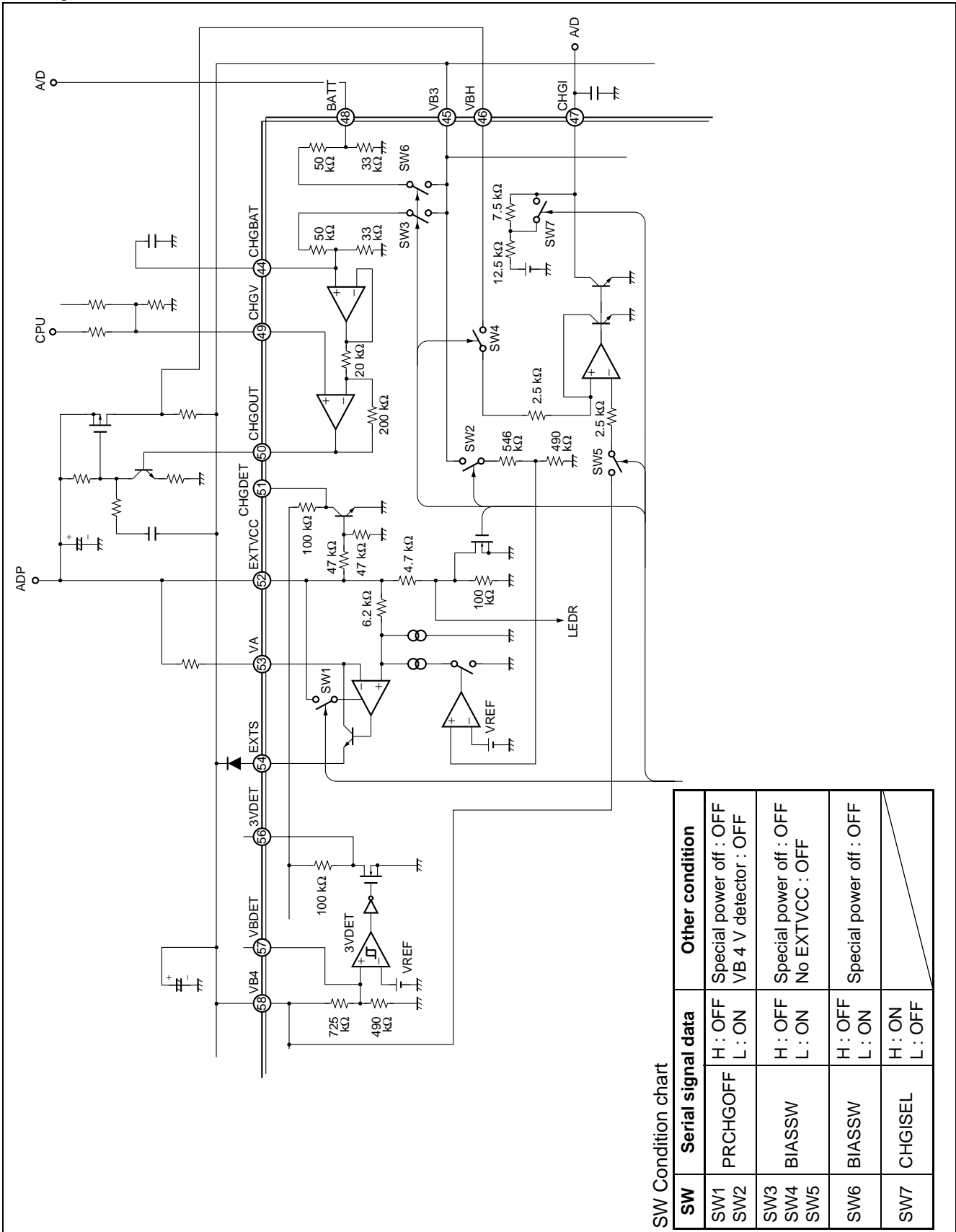

SW Condition chart

SW	Serial signal data	Other condition
SW1	H : OFF	Special power off : OFF VB 4 V detector : OFF
SW2	L : ON	
SW3	H : OFF	Special power off : OFF No EXT VCC : OFF
SW4	L : ON	
SW5	H : OFF	Special power off : OFF
SW6	L : ON	
SW7	H : ON L : OFF	

MB3892

• Speaker Amp.

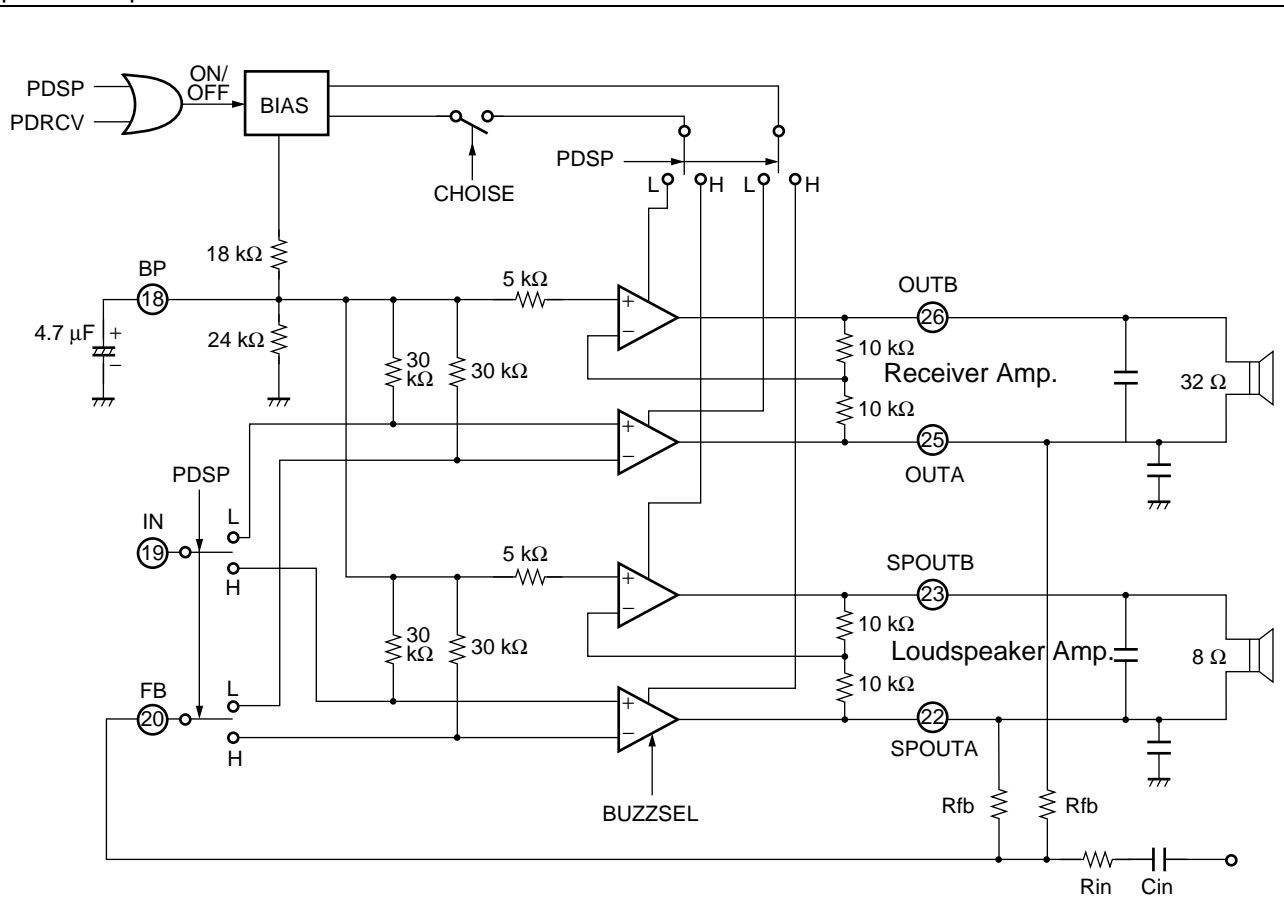

PDRCV	PDSP	CHOISE	BUZZSEL	Operating Amp.	Operation mode
L	L	×	×	—	Standby
H	L	H	L	Receiver Amp.	Receiver (BTL drive)
H	L	L	L	Receiver Amp.	Earphone mode (single drive)
L	H	H	L	Loudspeaker Amp.	Loudspeaker Amp. (BTL drive)
L	H	L	H	Loudspeaker Amp.	Short wave form output (open collector)
H	H	×	L	Loudspeaker Amp.	When both of PDRCV/PDSP is "H" level, the operation of loudspeaker Amp. has priority.

■ ABSOLUTE MAXIMUM RATINGS

Parameter	Symbol	Conditions	Rating		Unit
			Min.	Max.	
Power supply voltage	VB	—	—	7	V
	EXTVCC	—	—	7	V
Baseband regulator output current	Io	BBREG1	—	-110	mA
	Io	BBREG2	—	-150	mA
	Io	BBREG3	—	-60	mA
Receiver Amp. output current	Io	—	—	150	mA
Loudspeaker Amp. output current	Io	—	—	400	mA
Vibrator regulator output current	Io	—	—	-200	mA
RF regulator output current	Io	RFREG1	—	-10	mA
	Io	RFREG2	—	-20	mA
	Io	RFREG3	—	-20	mA
	Io	RFREG4	—	-60	mA
	Io	RFREG5	—	-200	mA
	Io	RFREG6	—	-50	mA
Variable regulator output current	Io	—	—	-15	mA
Power dissipation	P _D	T _a ≤ +25 °C	—	1420 *	mW
Storage temperature	T _{stg}	—	-55	+125	°C

*: The packages are mounted on the dual-sided epoxy board(10 cm × 10 cm)

WARNING: Semiconductor devices can be permanently damaged by application of stress (voltage, current, temperature, etc.) in excess of absolute maximum ratings. Do not exceed these ratings.

■ RECOMMENDED OPERATING CONDITIONS

Parameter	Symbol	Conditions	Value			Unit
			Min.	Typ.	Max.	
Power supply voltage	VB	—	2.85	—	5.5	V
	EXTVCC	Under 4.5 V preliminary charge circuit is not operated normally	3.0	—	6.5	V
REG capacitor ESR guarantee value	R _{ESR}	—	0.4	—	7	Ω
Operating ambient temperature	T _a	—	-30	+25	+80	°C

WARNING: The recommended operating conditions are required in order to ensure the normal operation of the semiconductor device. All of the device's electrical characteristics are warranted when the device is operated within these ranges.

Always use semiconductor devices within their recommended operating condition ranges. Operation outside these ranges may adversely affect reliability and could result in device failure.

No warranty is made with respect to uses, operating conditions, or combinations not represented on the data sheet. Users considering application outside the listed conditions are advised to contact their FUJITSU representatives beforehand.

■ ELECTRICAL CHARACTERISTICS

• Power control

(Ta = +25 °C, VB = 3.6 V)

Parameter		Symbol	Pin No.	Conditions	Value			Unit
					Min.	Typ.	Max.	
Reference voltage	Reference voltage	V _{REF}	27	VREF = 0 mA	1.19	1.23	1.27	V
Baseband regulator [BBREG1]	Output voltage	V _{O1}	75	OUT1 = 0 mA	2.79	2.85	2.91	V
		V _{OLD1}	75	OUT1 = -110 mA	2.79	2.85	2.91	V
	Line regulation	Line	75	VB = 3.1 to 4.8 V, OUT1 = -10 mA	—	—	20	mV
	Load regulation	Load	75	OUT1 = 0 to -110 mA	-30	—	0	mV
	Ripple rejection	R.R	75	Vin = 0.2 Vrms, f = 1 kHz, OUT1 = -10 mA	—	-50*	—	dB
	Reverse current	I _{REV}	75	VB = 0 to 5 V or VB = Open	—	30	43	μA
	Rise time	T _R	75	OUT1 = 2.2 μF, OUT1 = 27 Ω	—	—	60	μs
Baseband regulator [BBREG2]	Output voltage	V _{O2}	72, 73	OUT2 = 0 mA	2.79	2.85	2.91	V
		V _{OLD2}	72, 73	OUT2 = -150 mA	2.79	2.85	2.91	V
	Line regulation	Line	72, 73	VB = 3.1 to 4.8 V, OUT2 = -10 mA	—	—	20	mV
	Load regulation	Load	72, 73	OUT2 = 0 to -150 mA	-30	—	0	mV
	Ripple rejection	R.R	72, 73	Vin = 0.2 Vrms, f = 1 kHz, OUT2 = -10 mA	—	-50*	—	dB
	Rise time	T _R	72, 73	OUT2 = 10 μF, OUT2 = 20 Ω	—	—	190	μs
Baseband regulator [BBREG3]	Output voltage	V _{O3}	71	OUT3 = 0 mA	2.79	2.85	2.91	V
		V _{OLD3}	71	OUT3 = -60 mA	2.79	2.85	2.91	V
	Line regulation	Line	71	VB = 3.1 to 4.8 V, OUT3 = -10 mA	—	—	20	mV
	Load regulation	Load	71	OUT3 = 0 to -60 mA	-30	—	0	mV
	Ripple rejection	R.R	71	Vin = 0.2 Vrms, f = 1 kHz, OUT3 = -10 mA	—	-50*	—	dB
	Reverse current	I _{REV}	71	VB = 0 to 5 V or VB = Open	—	0	1	μA
	Rise time	T _R	71	OUT3 = 2.2 μF, OUT3 = 47 Ω	—	—	105	μs

* : Standard design value

(Continued)

MB3892

(Ta = +25 °C, VB = 3.6 V)

Parameter	Symbol	Pin No.	Conditions	Value			Unit	
				Min.	Typ.	Max.		
Backup regulator [BATTREG]	Output voltage	V _{BATT}	69	BATTOUT = 0 mA	3.00	3.10	3.20	V
	Output current	I _{BATT}	69	BATTOUT = 0 V	—	-3.1	—	mA
	Reverse current	I _{REV}	69	VB = 0 to 5 V or VB = Open	—	0	1	μA
Vibrator drive circuit [VIBREG]	Output voltage	V _O	78, 79	VIBREG = 0 mA	1.44	1.50	1.56	V
		V _{OLD}	78, 79	VIBREG = -200 mA	1.38	1.50	1.56	V
RF regulator [RFREG1]	Output voltage	V _{O1}	42	RFOUT1 = 0 mA	2.79	2.85	2.91	V
		V _{OLD1}	42	RFOUT1 = -10 mA	2.79	2.85	2.91	V
	Line regulation	Line	42	VB = 3.1 to 4.8 V, RFOUT1 = -10 mA	—	—	20	mV
	Load regulation	Load	42	RFOUT1 = 0 to -10 mA	-30	—	0	mV
	Ripple rejection	R.R	42	Vin = 0.2 Vrms, f = 1 kHz, RFOUT1 = -10 mA	—	-55*	—	dB
	Rise time	T _R	42	RFOUT1 = 2.2 μF, RFOUT1 = 300 Ω	—	—	630	μs
RF regulator [RFREG2]	Output voltage	V _{O2}	40	RFOUT2 = 0 mA	2.79	2.85	2.91	V
		V _{OLD2}	40	RFOUT2 = -20 mA	2.79	2.85	2.91	V
	Line regulation	Line	40	VB = 3.1 to 4.8 V, RFOUT2 = -10 mA	—	—	20	mV
	Load regulation	Load	40	RFOUT2 = 0 to -20 mA	-30	—	0	mV
	Ripple rejection	R.R	40	Vin = 0.2 Vrms, f = 1 kHz, RFOUT2 = -10 mA	—	-55*	—	dB
	Rise time	T _R	40	RFOUT2 = 2.2 μF, RFOUT2 = 150 Ω	—	—	315	μs
RF regulator [RFREG3]	Output voltage	V _{O3}	38	RFOUT3 = 0 mA	2.79	2.85	2.91	V
		V _{OLD3}	38	RFOUT3 = -20 mA	2.79	2.85	2.91	V
	Line regulation	Line	38	VB = 3.1 to 4.8 V, RFOUT3 = -10 mA	—	—	20	mV
	Load regulation	Load	38	RFOUT3 = 0 to -20 mA	-30	—	0	mV
	Ripple rejection	R.R	38	Vin = 0.2 Vrms, f = 1 kHz, RFOUT3 = -10 mA	—	-55*	—	dB
	Rise time	T _R	38	RFOUT3 = 2.2 μF, RFOUT3 = 150 Ω	—	—	315	μs

* : Standard design value

(Continued)

(Ta = +25 °C, VB = 3.6 V)

Parameter		Symbol	Pin No.	Conditions	Value			Unit
					Min.	Typ.	Max.	
RF regulator [RFREG4]	Output voltage	V _{O4}	35	RFOUT4 = 0 mA	2.79	2.85	2.91	V
		V _{OLD4}	35	RFOUT4 = -60 mA	2.79	2.85	2.91	V
	Line regulation	Line	35	VB = 3.1 to 4.8 V, RFOUT4 = -10 mA	—	—	20	mV
	Load regulation	Load	35	RFOUT4 = 0 to -60 mA	-30	—	0	mV
	Ripple rejection	R.R	35	Vin = 0.2 Vrms, f = 1 kHz, RFOUT4 = -10 mA	—	-55*	—	dB
	Rise time	T _R	35	RFOUT4 = 3.1 μF, RFOUT4 = 51 Ω	—	—	160	μs
RF regulator [RFREG5]	Output voltage	V _{O5}	29, 30	RFOUT5 = 0 mA	2.79	2.85	2.91	V
		V _{OLD5}	29, 30	RFOUT5 = -200 mA	2.79	2.85	2.91	V
	Line regulation	Line	29, 30	VB = 3.1 to 4.8 V, RFOUT5 = -10 mA	—	—	20	mV
	Load regulation	Load	29, 30	RFOUT5 = 0 to -200 mA	-30	—	0	mV
	Ripple rejection	R.R	29, 30	Vin = 0.2 Vrms, f = 1 kHz, RFOUT5 = -10 mA	—	-55*	—	dB
	Rise time	T _R	29, 30	RFOUT5 = 3.3 μF, RFOUT5 = 15 Ω	—	—	50	μs
RF regulator [RFREG6]	Output voltage	V _{O6}	33	RFOUT6 = 0 mA	2.79	2.85	2.91	V
		V _{OLD6}	33	RFOUT6 = -50 mA	2.79	2.85	2.91	V
	Line regulation	Line	33	VB = 3.1 to 4.8 V, RFOUT6 = -10 mA	—	—	20	mV
	Load regulation	Load	33	RFOUT6 = 0 to -50 mA	-30	—	0	mV
	Ripple rejection	R.R	33	Vin = 0.2 Vrms, f = 1 kHz, RFOUT6 = -10 mA	—	-55*	—	dB
	Rise time	T _R	33	RFOUT6 = 4.7 μF, RFOUT6 = 62 Ω	—	—	270	μs

* : Standard design value

(Continued)

MB3892

(Continued)

(Ta = +25 °C, VB = 3.6 V)

Parameter		Symbol	Pin No.	Conditions	Value			Unit	
					Min.	Typ.	Max.		
RF regulator control	Input voltage	V _{IL}	41, 39, 37, 36, 31, 32	—	0	—	OUT1 × 0.3	V	
		V _{IH}	41, 39, 37, 36, 31, 32	—	OUT1 × 0.7	—	OUT1	V	
	Input current	I _{IL}	41, 39, 37, 36, 31, 32	RFCTL1 to RFCTL6 = 0 V	-1	—	1	μA	
		I _{IH}	41, 39, 37, 36, 31, 32	RFCTL1 to RFCTL6 = 2.85 V	22	28.5	41	μA	
Variable bias regulator [VARREG]	Input voltage range	V _{IN}	67	—	1.67	—	2.38	V	
	Output voltage range	V _O	68	—	2.00	—	2.85	V	
	Output voltage precision	V _{OP}	68	—	-2.5	—	2.5	%	
	Output current	I _O	68	—	-10	—	—	mA	
	Input current	I _{IL}	67	VREGIN = 0 V	-1	—	1	μA	
		I _{IH}	67	VREGIN = 2.85 V	22	28.5	41	μA	
D/A converter	System resolution	—	63, 62, 61	D/A1 to D/A3	—	—	8	bit	
		—	60	D/A4	—	—	10	bit	
	Differential non-linear type linearity error	L _E	60	60	D/A4 (Input code is 200)	-12	—	+12	LSB
			60	60	D/A4 (Input code is 100, and 300)	-9	—	+9	LSB
			60	60	D/A4 (Input code is 080, 180, 280, and 380)	-7	—	+7	LSB
			63, 62, 61	63, 62, 61	D/A1 to D/A3 (Input code is 040, 080, and 0C0)	-4	—	+4	LSB
			63, 62, 61, 60	63, 62, 61, 60	Other input code	-1.0	—	+1.0	LSB
	Output voltage range	V _{OC}	63, 62, 61, 60	D/AOUT1 to D/AOUT4 = -330 μA to 1 mA	0.5	—	2.5	V	
	Rise time	T _R	63, 62, 61, 60	D/AOUT1 to D/AOUT4 = 100 pF	—	—	20	μs	
	Output Noise	V _{NOVL}	63, 62, 61, 60	—	—	—	-77.8	dBm	

(Continued)

(Ta = +25 °C, VB = 3.6 V)

Parameter		Symbol	Pin No.	Conditions	Value			Unit
					Min.	Typ.	Max.	
Power-on reset	Detected voltage	V _{SL1}	75	—	2.63	2.685	2.74	V
		V _{SH1}	75	—	2.695	2.75	2.805	V
	Output voltage	V _{OH}	77	$\overline{\text{RESET}} = -200 \mu\text{A}$	OUT1 - 0.3	OUT1	—	V
		V _{OH}	77	$\overline{\text{RESET}} = 200 \mu\text{A}$	—	0.01	0.4	V
	POR hold time	T _{PR}	77	CTP ≤ 0.1 μF	25	70	115	ms
	Rise time	T _R	77	$\overline{\text{RESET}} = 50 \text{ pF}$	—	—	500	ns
	Fall time	T _F	77	$\overline{\text{RESET}} = 50 \text{ pF}$	—	—	500	ns
Supply voltage detector	Detected voltage	V _{3VDH}	56	—	2.99	3.05	3.11	V
		V _{3VDL}	56	—	2.79	2.85	2.907	V
Power control (General)	Power consumption current	I _{B1}	28, 34, 45, 58, 70, 74, 80	Special power off	—	11	20	μA
		I _{B2}	28, 34, 45, 58, 70, 74, 80	Standby	50	70	100	μA
		I _{B3}	28, 34, 45, 58, 70, 74, 80	Power on (waiting) intermittent	50	70	100	μA
		I _{B4}	28, 34, 45, 58, 70, 74, 80	Power on (waiting) receiving	190	250	360	μA
		I _{B5}	28, 34, 45, 58, 70, 74, 80	Power on (conversation) transmission	170	220	315	μA
		I _{B6}	28, 34, 45, 58, 70, 74, 80	Power on (conversation) receiving	190	250	360	μA

* : Standard design value

Note: I_{B1} to I_{B6} of general power control means the total current at VB1 to VB7 terminals the load current is not included. As for the condition of each regulators at the measurement of power consumption current, please refer to “■ CONDITIONS of EACH REGURATORS at MEASUREMENT of CONSUMPTION CURRENT”.

MB3892

- Speaker Amp.

(Ta = +25 °C, VB = V30R = 3.6 V, f = 1 kHz)

Parameter		Symbol	Pin No.	Conditions	Value			Unit
					Min.	Typ.	Max.	
Receiver Amp.	Voltage gain	AV1	25	Single drive, INV input FB = 4.7 kΩ, FB to OUTA = 15 kΩ	8.1	10.1	12.1	dB
		AV2	25, 26	BTL drive, INV input FB = 4.7 kΩ, FB to OUTA = 15 kΩ	14.1	16.1	18.1	dB
	Open-ended voltage gain	AVO	25, 26	f ≤ 100 Hz	—	80*	—	dB
	Output power	PO1	25, 26	V30R = 3.6 V, OUTA to OUTB = 32 Ω, THD = 10%	60	90	—	mW
		PO2	25, 26	V30R = 2.85 V, OUTA to OUTB = 32 Ω, THD = 10%	30	45	—	mW
	Output voltage	VO	25, 26	OUTA to OUTB = no load	3.8	5.5	—	V
	Offset voltage between output	VOO	25, 26	—	-50	—	50	mV
	Total harmonic distortion rate	THD	25, 26	PO = 25 mW	—	0.5	1.0	%
	Ripple rejection	R.R	25, 26	—	—	-45*	—	dB
Rise time	TR	25, 26	BP = 1 V, BP = 4.7 μF	—	—	0.1	s	
Loud speaker Amp.	Voltage gain	AV	22, 23	BTL drive, INV input FB = 4.7 kΩ, FB to SPOUTA = 15 kΩ	14.1	16.1	18.1	dB
	Open-ended voltage gain	AVO	22, 23	f ≤ 100 Hz	—	80*	—	dB
	Output power	PO1	22, 23	V30R = 3.6 V, SPOUTA to SPOUTB = 8 Ω, THD = 10%	160	260	—	mW
		PO2	22, 23	V30R = 2.85 V, SPOUTA to SPOUTB = 8 Ω, THD = 10%	50	110	—	mW
	Output voltage	VO	22, 23	SPOUTA to SPOUTB = no load	3.8	5.5	—	V
	Offset voltage between output	VOO	22, 23	—	-50	—	50	mV
	Overall harmonic distortion rate	THD	22, 23	PO = 60 mW	—	0.5	1.0	%
	Ripple rejection	R.R	22, 23	—	—	-45*	—	dB
	Rise time	TR	22, 23	BP = 1 V, BP = 4.7 μF	—	—	0.1	s
Speaker Amp.	Input impedance	RIN	19, 20	—	20	30	50	kΩ
	Standby supply current	ICC1	21	—	—	0	10	μA

* : Standard design value

- Sounder

(Ta = +25 °C, VB = 3.6 V)

Parameter		Symbol	Pin No.	Conditions	Value			Unit
					Min.	Typ.	Max.	
Sounder	Output voltage	V _{O1}	16	VO1 = 200 mA	—	0.3	0.5	V
		V _{O2}	14	VO2 = 100 mA	—	0.3	0.5	V
		V _{O3}	13	VO3 = 50 mA	—	0.3	0.5	V
	Output leakage current	I _{LEAK}	16, 14, 13	VB = VO1 to VO3 = 6 V	—	—	10	μA
	Conditions for input ON	V _{ON}	10, 11, 12	—	VB × 0.7	—	VB	V
		V _{OFF}	10, 11, 12	—	0.0	—	VB × 0.3	V
	Input current	I _{IH}	10, 11, 12	IN1 to IN3 = 3 V	-1	—	1	μA
I _{IL}		10, 11, 12	IN1 to IN3 = 0.4V	-1	—	1	μA	

- LED drive

(Ta = +25 °C, VB = 3.6 V)

Parameter		Symbol	Pin No.	Conditions	Value			Unit
					Min.	Typ.	Max.	
LED drive	Output voltage	V _{LE1}	2	LEDO1 = 25 mA	—	0.2	0.4	V
		V _{LE2}	4	LEDO2 = 25 mA	—	0.2	0.4	V
		V _{LER}	1	LEDR = 25 mA	—	0.2	0.4	V
	Output leakage current	I _{LEAK}	2, 4, 1	VB = VO1 to VO3 = 6 V	—	—	10	μA

MB3892

- Charge control

(Ta = +25 °C, EXTVCC = 5.2 V)

Parameter	Symbol	Pin No.	Conditions	Value			Unit	
				Min.	Typ.	Max.		
Charge control	Control input range	ΔV_{CHG}	49	—	0.8	—	2.5	V
	Control output minimum voltage	V_{COL}	50	EXTVCC = 6 V	—	—	0.1	V
	Control output maximum voltage	V_{COH}	50	EXTVCC = 6 V	EXTVCC - 0.5	—	—	V
	Control input current	I_{CHGV}	49	CHGV = 4 V	—	—	5	μA
	Control output voltage	V_{GG1}	50	VB = 4 V, CHGV = 1.59 V	0.85	1.44	2.15	V
		V_{GG2}	50	VB = 4 V, CHGV = 1.69 V	1.85	2.44	3.15	V
	Control gain	V_{GG}	50	$20 \log\{ (V_{\text{GG2}} - V_{\text{GG1}}) / 0.1 \}$	18.8	20.8	22.8	dB
	BATT detected voltage	V_{BATT}	48	VB = 3.6 V	1.35	1.43	1.52	V
V_{CHGBAT}		44	VB = 3.6 V	1.35	1.43	1.52	V	
Charge current detector	VBH input voltage range	V_{BH}	46	EXTVCC = 6 V	1.0	—	5.0	V
	VBH input leakage current	I_{LBH}	46	VB = VBH = 4 V, EXTVCC = 0 V	—	—	10	μA
	Chage control output voltage	V_{CUR1}	47	Low precision VB = VBH = 3.6 V	1.8	2.0	2.2	V
		V_{CUR2}	47	Low precision VB = 3.6 V, VBH = 3.75 V	1.05	1.25	1.45	V
		V_{CUR3}	47	High precision VB = VBH = 3.6 V	1.8	2.0	2.2	V
		V_{CUR4}	47	High precision VB = 3.6 V, VBH = 3.75 V	0.48	0.8	1.12	V
	Current detected sensitivity	V_{CURG1}	47	$20 \log\{ (V_{\text{CUR1}} - V_{\text{CUR2}}) / 0.15 \}$	12	14	16	dB
		V_{CURG2}	47	$20 \log\{ (V_{\text{CUR3}} - V_{\text{CUR4}}) / 0.15 \}$	16	18	20	dB

(Continued)

(Continued)

(Ta = +25 °C, EXTVCC = 5.2 V)

Parameter	Symbol	Pin No.	Conditions	Value			Unit	
				Min.	Typ.	Max.		
Preliminary charge circuit	Switching voltage of charge current	V _{B1}	28, 34, 45, 58, 70, 74, 80	—	2.5	2.6	2.7	V
		V _{B2}	28, 34, 45, 58, 70, 74, 80	—	3.8	4.0	4.2	V
	Charge current	I _{B1}	54	—	40	50	60	mA
		I _{B2}	54	—	80	100	120	mA
Exterenal power supply detector	CHGDET output voltage	V _{CDL}	51	EXTVCC = 2 V, CHGDET = 0 A	—	—	0.3	V
		V _{CDH}	51	EXTVCC = 0.6 V, CHGDET = 0 A	OUT1 – 0.2	OUT1	—	V

- Serial control

(Ta = +25 °C, VB = 3.6 V)

Parameter	Symbol	Pin No.	Conditions	Value			Unit	
				Min.	Typ.	Max.		
Serial control	Input voltage	V _{IL}	6, 7, 8	—	0	—	OUT1 × 0.3	V
		V _{IH}	6, 7, 8	—	OUT1 × 0.7	—	OUT1	V
	Input current	I _{IL}	6, 7, 8	DAT = SCLK = STBIN = 0 V	–1	—	1	μA
		I _{IH}	6, 7, 8	DAT = SCLK = STBIN = 2.85 V	–1	—	1	μA

- Special power off

(Ta = +25 °C, VB = 3.6 V)

Parameter	Symbol	Pin No.	Conditions	Value			Unit	
				Min.	Typ.	Max.		
Special power off	Output voltage	V _{IPOFF}	59	IPOFF = 0 A	VB – 0.1	VB	—	V
	IPOFFmode release voltage	V _{RELEASE}	59	—	—	—	VB × 0.3	V

TYPICAL CHARACTERISTICS

Power supply current vs. power supply voltage

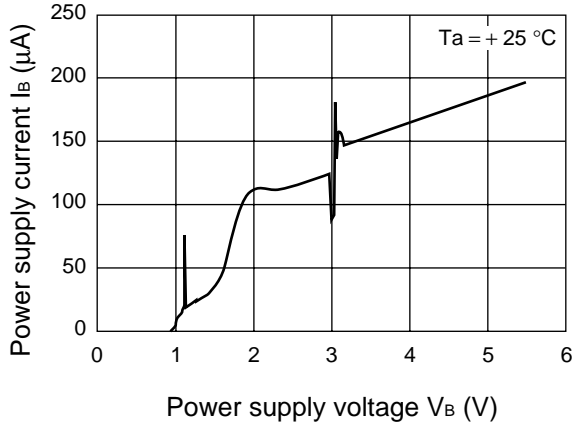

Reference voltage vs. power supply voltage

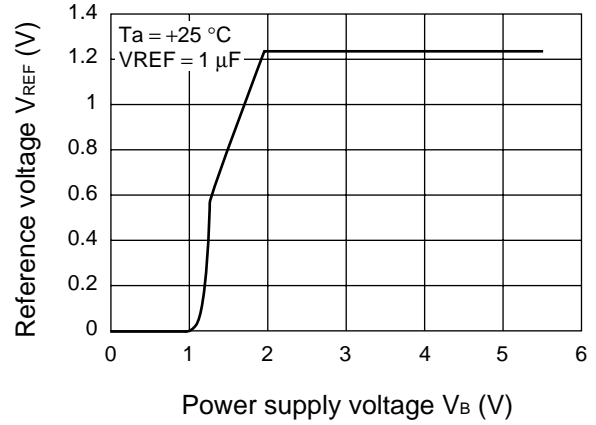

Reference voltage vs. ambient temperature

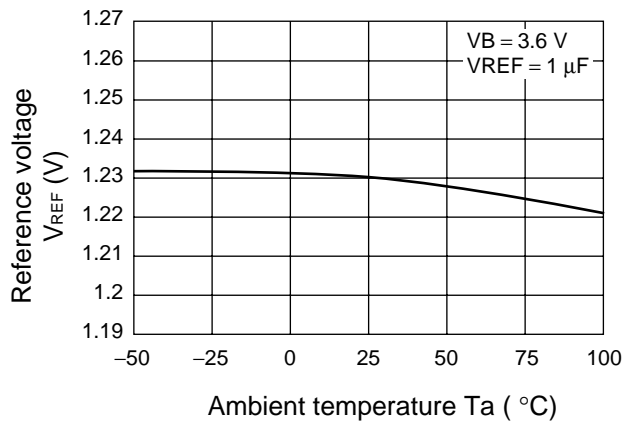

Output voltage vs. ambient temperature (BBREG2)

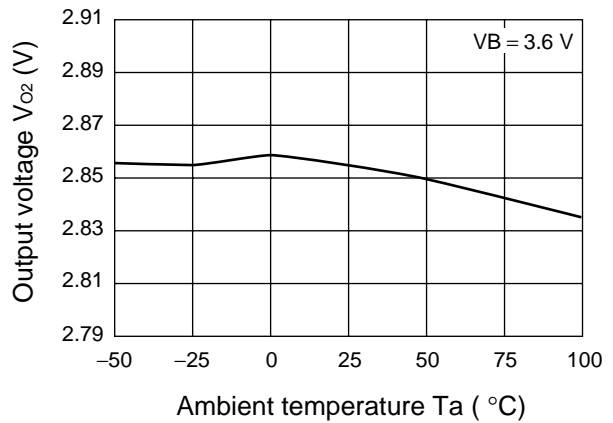

Output voltage vs. power supply voltage (BBREG1)

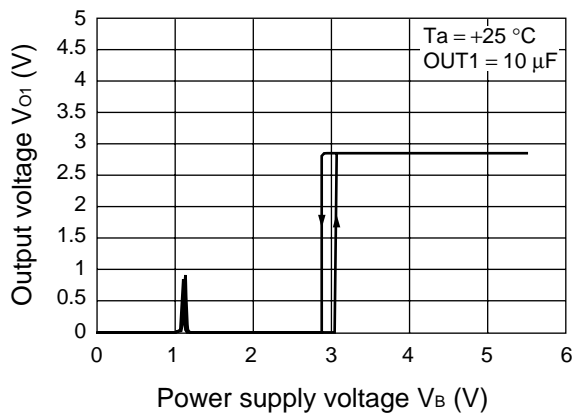

Output voltage vs. power supply voltage (BBREG2)

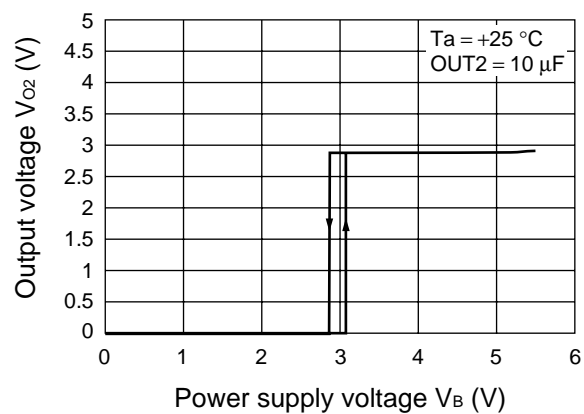

(Continued)

Output voltage vs. power supply voltage (BBREG3)

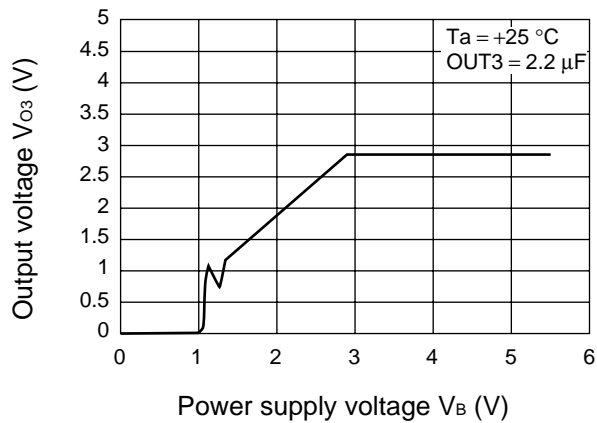

Output voltage vs. power supply voltage (BATTREG)

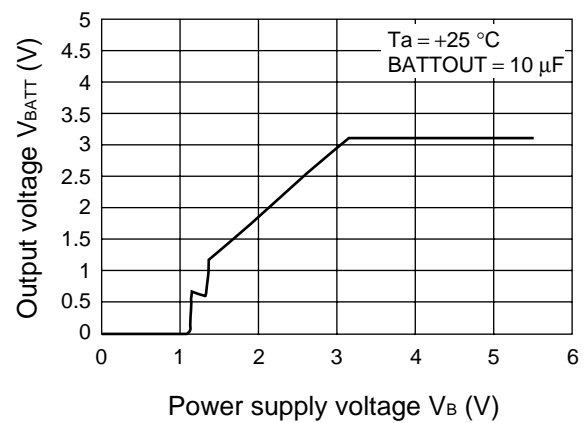

Output voltage vs. power supply voltage (RFREG1)

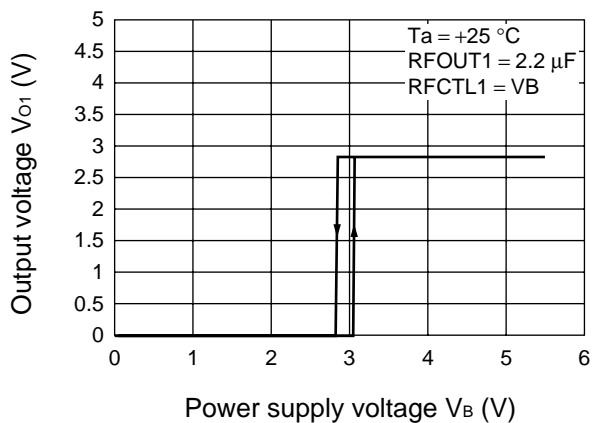

Output voltage vs. control voltage (RFREG1)

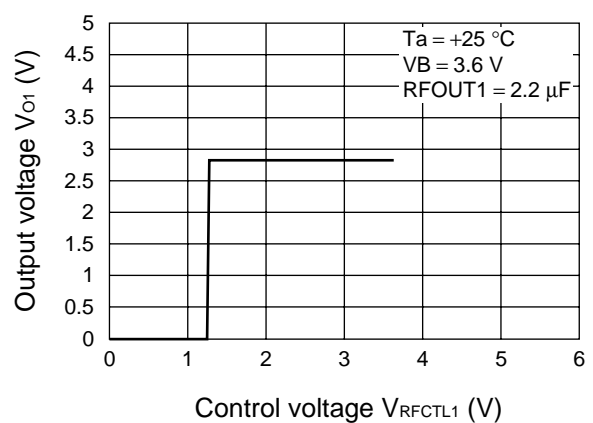

Output voltage vs. input voltage (Variable REG)

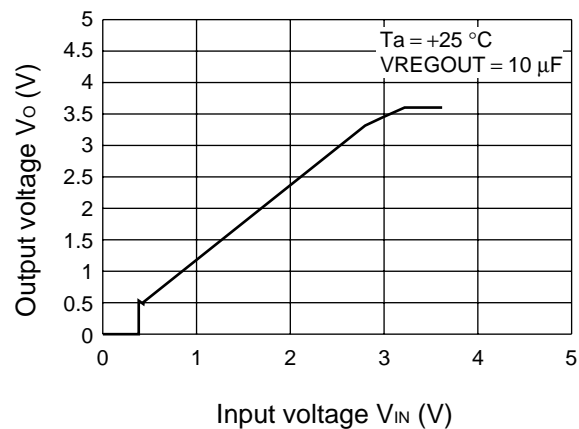

Input current vs. input voltage (Variable REG)

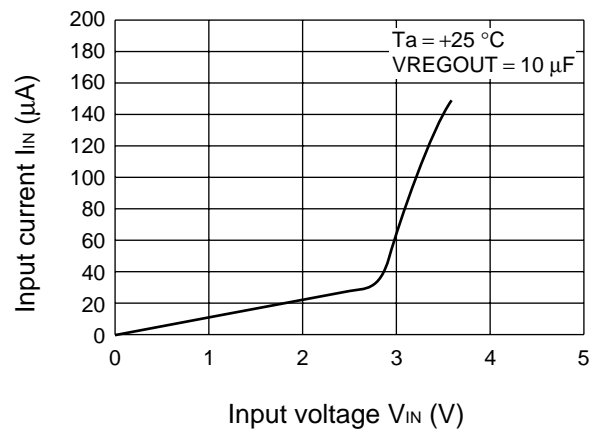

(Continued)

DA1 output voltage vs. output current

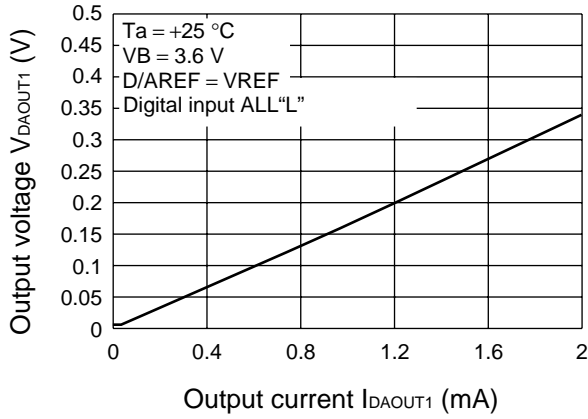

DA1 output voltage vs. output current

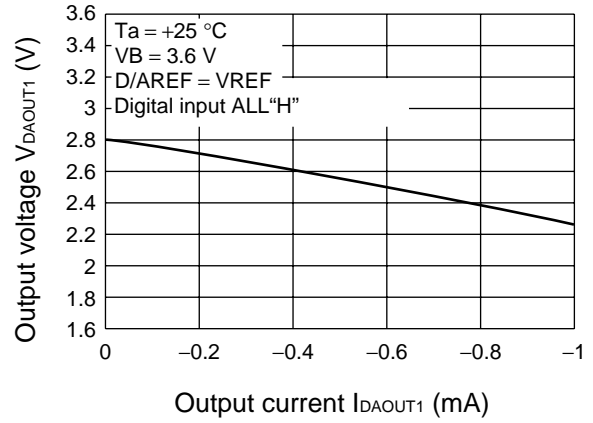

DA4 output voltage vs. output current

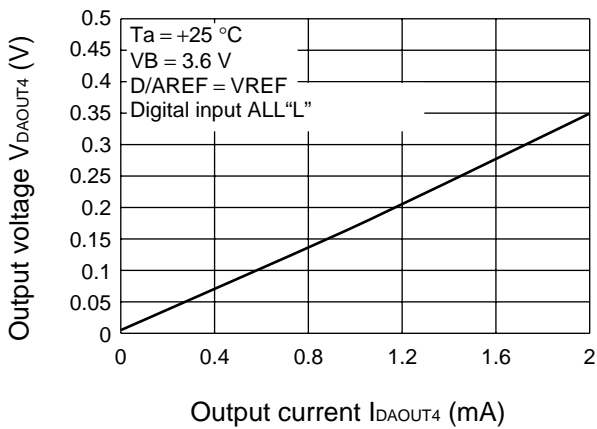

DA4 output voltage vs. output current

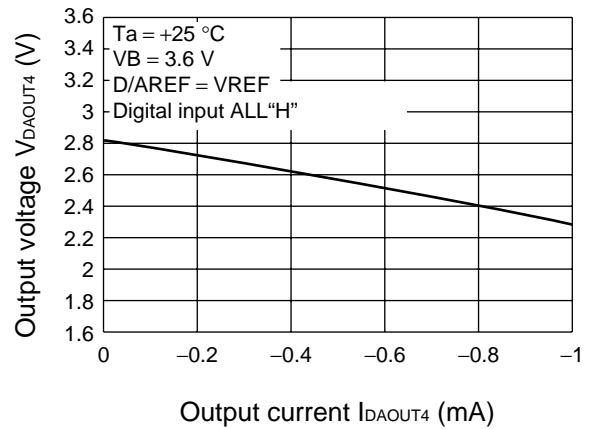

Reset output voltage vs. REG1 output voltage

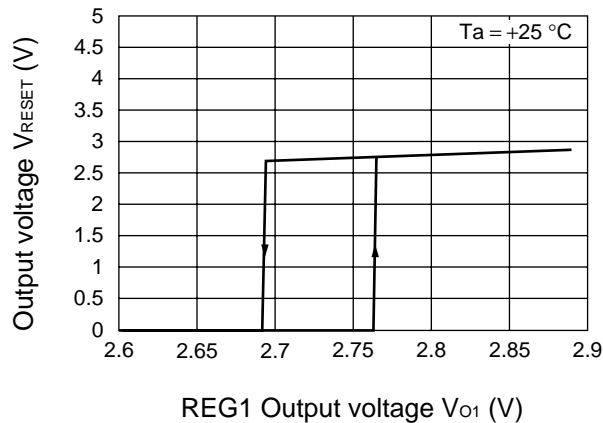

Hold time for power-on-reset

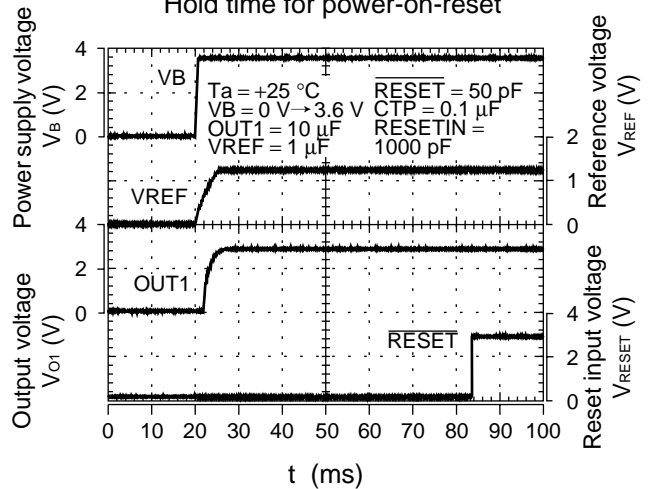

(Continued)

Power supply voltage detected output voltage vs. power supply voltage

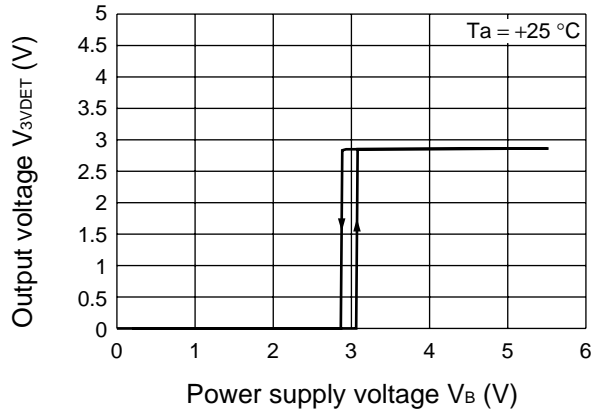

Power supply voltage detected output voltage vs. power supply voltage

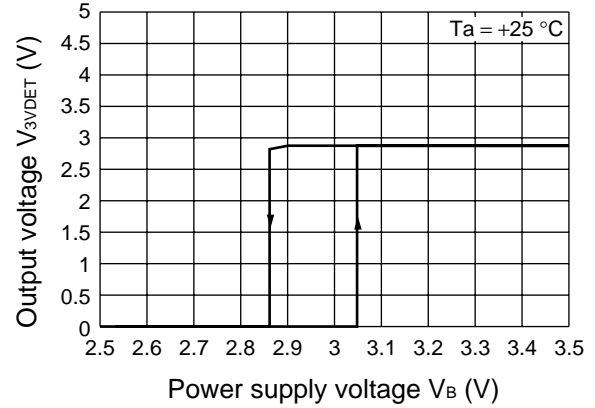

Total harmonic distortion rate vs. output power (receiver Amp.)

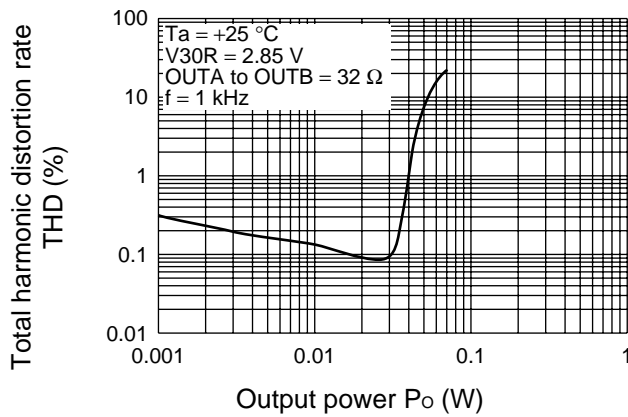

Total harmonic distortion rate vs. output power (receiver Amp.)

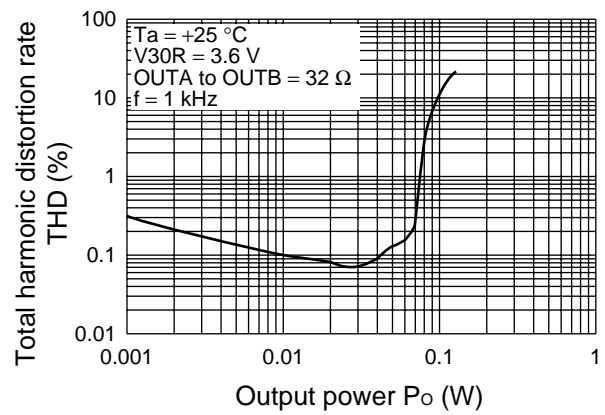

Total harmonic distortion rate vs. output power (Loudspeaker Amp.)

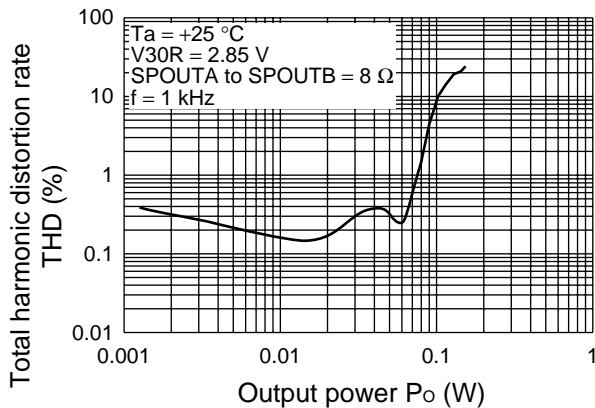

Total harmonic distortion rate vs. output power (Loudspeaker Amp.)

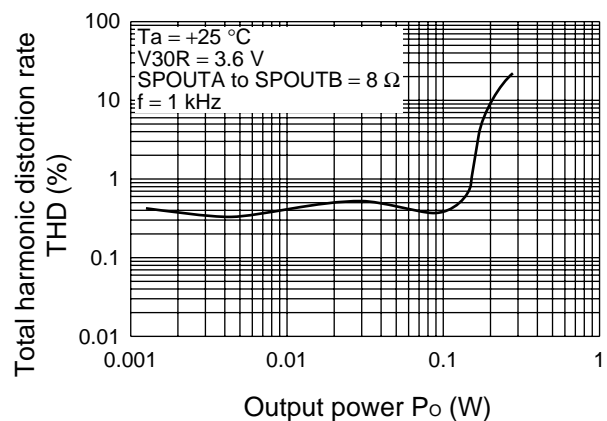

(Continued)

Sounder1 output voltage vs. output current

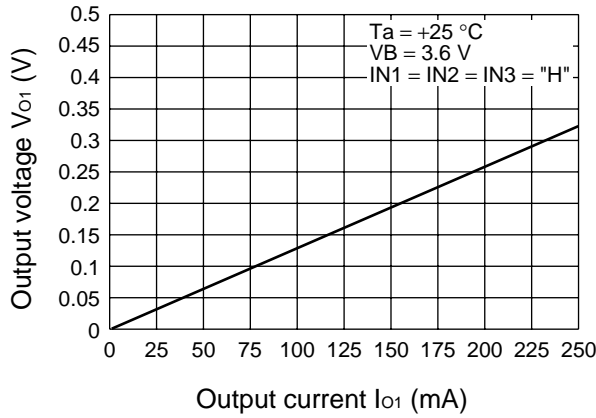

Sounder2 output voltage vs. output current

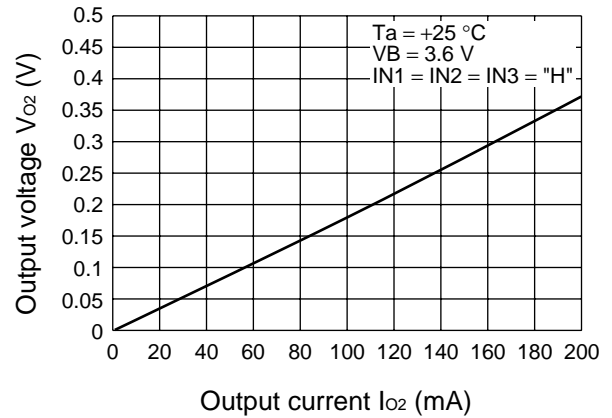

Sounder3 output voltage vs. output current

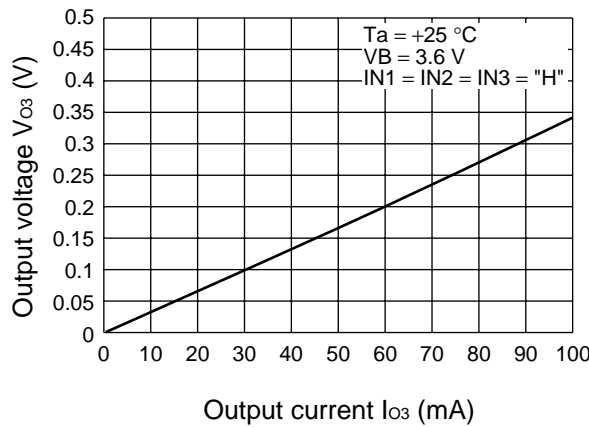

LEDR output voltage vs. output current

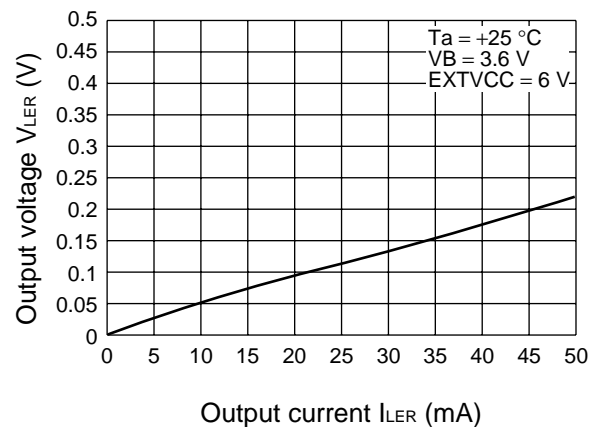

LED1 output voltage vs. output current

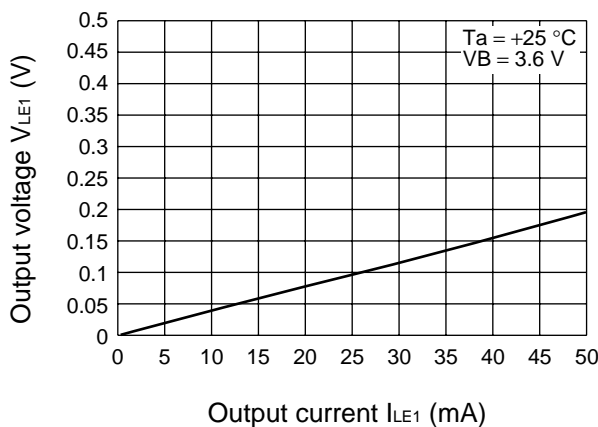

LED2 output voltage vs. output current

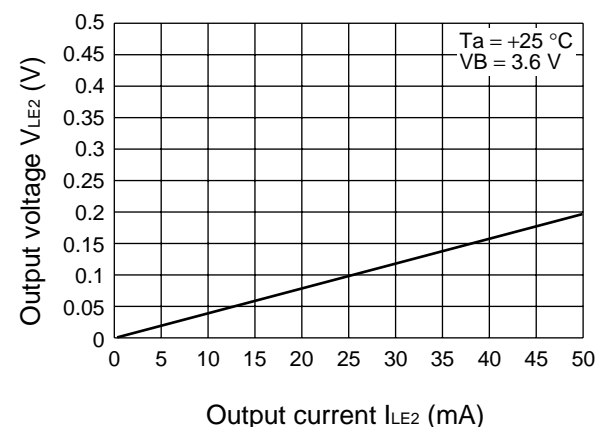

(Continued)

CHGOUT output voltage vs. CHGV input voltage

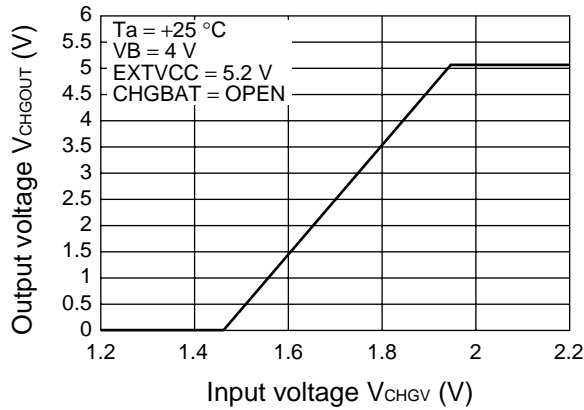

CHGOUT output voltage vs. CHGV input voltage

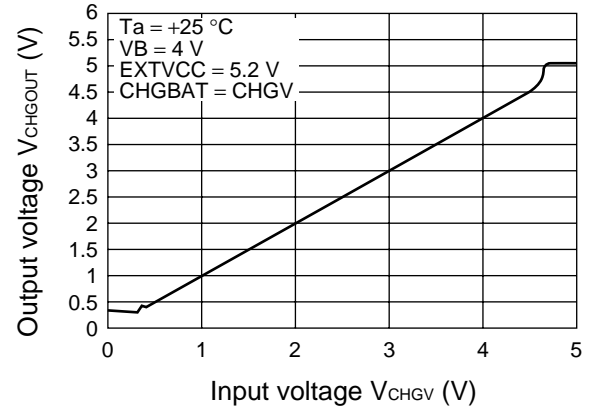

CHGI output voltage vs. VBH input voltage

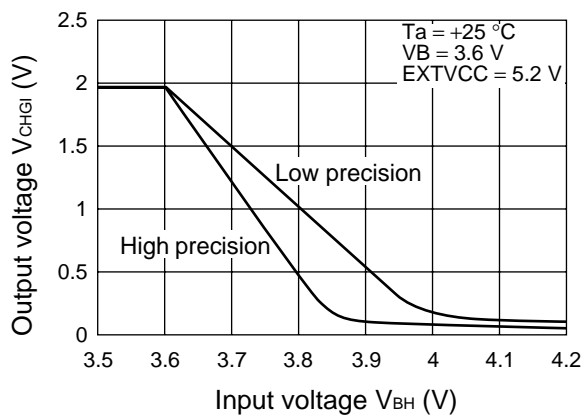

CHGI output voltage vs. VBH input voltage

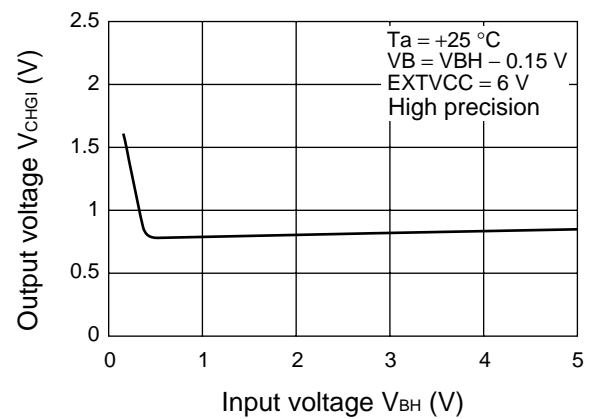

Preliminary charge current vs. VB power supply voltage

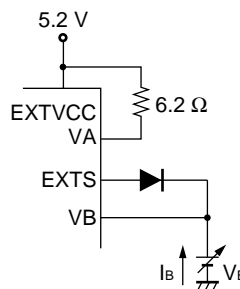
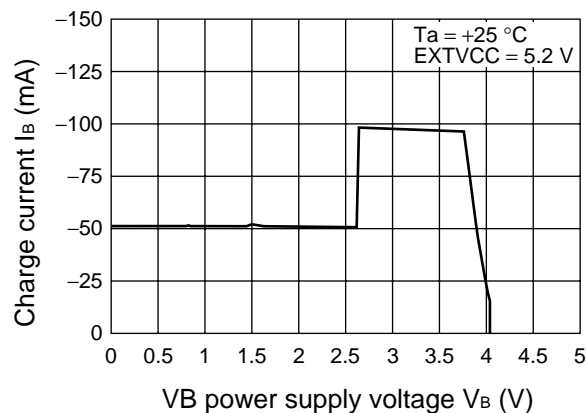

(Continued)

(Continued)

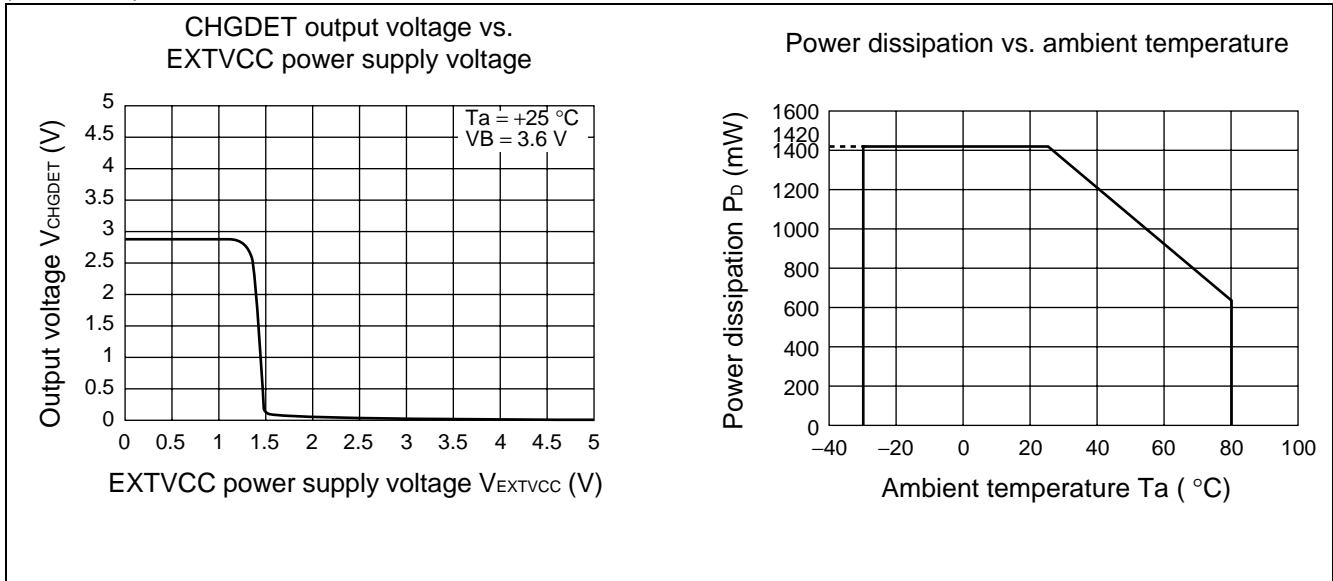

■ FUNCTIONAL DESCRIPTION

1. Power Control

(1) Reference voltage

This circuit uses the voltage generated by VB1 terminal (pin 28) to produce a temperature compensated reference voltage (1.23 V typ.) for power control and uses this reference voltage on power control.

(2) Baseband regulator (BBREG1)

This regulator uses the reference voltage to produce an output voltage (2.85V typ.) at OUT1 terminal (pin 75). Power can be drawn from OUT1 terminal for external use, up to a maximum load current of 110 mA.

(3) Baseband regulator (BBREG2)

This regulator uses the reference voltage to produce an output voltage (2.85 V typ.) at OUT2 terminal (OUT2-1 terminal (pin 72), OUT2-2 terminal (pin73)).

Power can be drawn from OUT2 terminal for external use, up to a maximum load current of 150 mA.

(4) Baseband regulator (BBREG3)

This regulator uses the reference voltage to produce an output voltage (2.85V typ.) at OUT3 terminal (pin 71). Power can be drawn from OUT3 terminal for external use, up to a maximum load current of 60mA.

(5) Battery backup regulator (BATTREG)

This regulator uses the reference voltage to produce an output voltage (3.1V typ.) at BATTOUT terminal (pin 69).

(6) Vibrator drive circuit (VIBREG)

This circuit uses the reference voltage to produce an output voltage (1.5V typ.) at VIBREG terminal (VIBREG-1 terminal (pin 78), VIBREG-2 terminal (pin 79)).

Power can be drawn from VIBREG terminal for external use, up to a maximum load current of 200mA.

(7) RF regulator (RFREG1)

This regulator uses the reference voltage to produce an output voltage (2.85V typ.) at RFOUT1 terminal (pin 42) when an "H" level signal is input at the RFCTL1 terminal (pin 41).

Power can be drawn from RFOUT1 terminal for external use, up to a maximum load current of 10mA.

(8) RF regulator (RFREG2)

This regulator uses the reference voltage to produce an output voltage (2.85V typ.) at RFOUT2 terminal (pin 40) when an "H" level signal is input at the RFCTL2 terminal (pin 39).

Power can be drawn from RFOUT2 terminal for external use, up to a maximum load current of 20mA.

(9) RF regulator (RFREG3)

This regulator uses the reference voltage to produce an output voltage (2.85V typ.) at RFOUT3 terminal (pin 38) when an "H" level signal is input at the RFCTL3 terminal (pin 37).

Power can be drawn from RFOUT3 terminal for external use, up to a maximum load current of 20mA.

(10) RF regulator (RFREG4)

This regulator uses the reference voltage to produce an output voltage (2.85V typ.) at RFOUT4 terminal (pin 35) when an "H" level signal is input at the RFCTL4 terminal (pin 36).

Power can be drawn from RFOUT4 terminal for external use, up to a maximum load current of 60mA.

(11) RF regulator (RFREG5)

This regulator uses the reference voltage to produce an output voltage (2.85V typ.) at RFOUT5 terminal (RFOUT5-1 terminal (pin 30), RFOUT5-2 terminal (pin 29)) when an "H" level signal is input at the RFCTL5 terminal (pin 31).

Power can be drawn from RFOUT5 terminal for external use, up to a maximum load current of 200mA.

(12) RF regulator (RFREG6)

This regulator uses the reference voltage to produce an output voltage (2.85V typ.) at RFOUT6 terminal (pin 33) when an "H" level signal is input at the RFCTL6 terminal (pin 32).

Power can be drawn from RFOUT6 terminal for external use, up to a maximum load current of 50mA.

(13) Variable bias regulator

This regulator uses the voltage generated by VREGIN terminal (pin 67) to produce an amplified output voltage at VREGOUT terminal (pin 68).

Power can be drawn from VREGOUT terminal for external use, up to a maximum load current of 10mA.

(14) D/A converter

D/A1 to D/A3 converter process 8 bit input signal and D/A4 converter processes 10 bit input signal.

This converter generates an output voltage (0.5 to 2.5V) at D/AOUT1 terminal (pin 63) to D/AOUT4 terminal (pin 60) according to the signal from serial control.

(15) Power-on reset

When the OUT1 terminal (pin 75) voltage exceeds 2.75V(typ.) , after a delay interval set by a capacitor (0.1 μ F typ.) connected to the CTP terminal (pin 76) , the $\overline{\text{RESET}}$ terminal (pin 77) voltage becomes "H" level from "L" level and the reset signal is canceled.

When the OUT1 terminal voltage falls below 2.685V (typ.), the $\overline{\text{RESET}}$ terminal voltage becomes "L" level from "H" level and the reset signal is dispatched. (refer to "■POWER-ON RESET TIMING DIAGRAM", "■SETTING OF HOLD TIME FOR POWER-ON RESET".)

(16) Battery voltage detect

This function is to observe the battery voltage. When the VB4 terminal (pin 58) voltage exceeds 3.05V (typ.), the 3VDET terminal (pin 56) voltage goes to "H" level and when the VB4 terminal voltage falls below 2.85V (typ.), the 3VDET terminal goes to "L" level. (refer to ■BATTERY VOLTAGE DETECTOR)

2. Speaker Amp.

(1) Receiver Amp.

This is the BTL output type Amp. driving speaker directly. When the output power is 90mW typ. (at 32Ω), the serial control processes the on/off and the earphone switching control.

The optional gain can be set by the connection of feedback resistor from FB terminal (pin 20) to OUTA terminal (pin 25) and the connection of input resistor to FB terminal.

(2) Loudspeaker Amp.

This is the BTL output type Amp. driving speaker directly. When the output power is 260mW typ. (at 8Ω), the serial control processes the on/off control.

The optional gain can be set by the connection of feedback resistor from FB terminal (pin 20) to SPOUTA terminal (pin 22) and the connection of input resistor to FB terminal.

3. Sounder

Three low-saturation output transistors are built in for buzzer drive. When the signal from serial control is "H" level and IN1 terminal (pin 10) voltage is "H" level, the V01 terminal (pin 16) voltage is 0.3V (typ.). When IN2 terminal (pin 11) voltage and IN3 terminal (pin 12) voltage are "H" level, the V02 terminal (pin 14) voltage and V03 terminal (pin 13) voltage are also 0.3V (typ.).

4. LED drive

The LEDO1 terminal (pin 2) voltage and LEDO2 terminal (pin 4) voltage is 0.2V (typ.), when the signal from serial control is "H" level. When the signal from charge control is "H" level, the LEDR terminal (pin 1) voltage is 0.2V (typ.).

5. Charge control

(1) Charge control

The main charge is started by the signal from serial control indicates preliminary charge is finished.

According to the voltage level at CHGV terminal (pin 49) generated by microprocessor on the microprocessor operation, the charge current is controlled by adjusting gate voltage from outside FET.

(2) Charge current detector

The charge current detector sensitivity (gain) can be switched by the signal from serial control.

The VBH terminal (pin 46) voltage and VB4 terminal voltage (pin 58) are detected and CHGI terminal (pin 47) voltage is generated.

(3) Preliminary charge circuit

When the battery voltage is low, the charge is controlled until the microprocessor starts the operation.

Before the battery voltage reaches 2.6V (typ.), 50mA (typ.) is used for the charge and before 4V (typ.), 100mA (typ.) is used.

(4) External power supply detector

This function is to detect if the case is attached to the battery charger.

When the case is attached to the battery charger, EXTVCC terminal (pin 52) voltage is "H" level and generate "L" level voltage at CHGDET terminal (pin 51). When the case is not attached to the battery charger, EXTVCC terminal voltage is "L" level and generate "H" level voltage at CHGDET terminal.

6. Serial control

After the input signal from microprocessor at DAT terminal (pin 6) is captured at the rising edge of SCLK terminal (pin 7), the signal is input in the internal register at the rising edge of STBIN terminal (pin8) and mode is set.

7. Special power off

This function can control the power consumption current of main IC under 11 μ A (typ.) and the battery can be kept for the long period under the conditions that battery package is attached to the mobile phone on the shipment.

■ CONDITIONS of EACH REGULATORS at MEASUREMENT of CONSUMPTION CURRENT

Each regulators conditions at the measurement of consumption current are as the following table.

[BIASSW] signal of serial control is "H" level (BIASSW OFF) .

		BBREG1	BBREG2	BBREG3	BATTREG	VIBREG	VARREG	RFREG1
Special power off	IB1	OFF	OFF	OFF	OFF	OFF	OFF	OFF
Standby	IB2	ON	OFF	ON	ON	OFF	OFF	OFF
Power on (waiting/intermittent)	IB3	ON	OFF	ON	ON	OFF	OFF	OFF
Power on (waiting/receiving)	IB4	ON	ON	ON	ON	OFF	OFF	ON
Power on (conversation/ transmission)	IB5	ON	ON	ON	ON	OFF	OFF	ON
Power on (conversation/receiving)	IB6	ON	ON	ON	ON	OFF	OFF	ON

		RFREG2	RFREG3	RFREG4	RFREG5	RFREG6	Receiver Amp.	Loudspeaker Amp.
Special power off	IB1	OFF	OFF	OFF	OFF	OFF	OFF	OFF
Standby	IB2	OFF	OFF	OFF	OFF	OFF	OFF	OFF
Power on (waiting/intermittent)	IB3	OFF	OFF	OFF	OFF	OFF	OFF	OFF
Power on (waiting/receiving)	IB4	ON	ON	ON	OFF	ON	OFF	OFF
Power on (conversation/ transmission)	IB5	ON	OFF	OFF	ON	ON	ON	OFF
Power on (conversation/ receiving)	IB6	ON	ON	ON	OFF	ON	ON	OFF

MB3892

LOGICS

(1) Serial Control Setting Table

A7	A6	A5	A4	A3	A2	A1	A0
1	1	1	1	1	1	1	0

	D9	D8	D7	D6	D5	D4	D3	D2	D1	D0
Data	PDSP	PDRCV	CHOISE	LEDC1 (green)	LEDC2 (red)	BIASSW	REG2CTL	VIBCTL	LEDRCTL	VREGCTL
Operation at data "1"	Loud AMPON	Receiver AMPON	BTL drive	ON	ON	OFF	OFF	VIB REGON	Charge red LEDOFF	Variable REGON
Operation at data "0"	Loud AMPOFF	Receiver AMPOFF	Single drive	OFF	OFF	ON	ON	VIB REGOFF	Charge red LEDON	Variable REGOFF
Initial value after reset	0	0	0	0	0	0	0	0	0	0

A7	A6	A5	A4	A3	A2	A1	A0
1	1	1	1	1	1	0	1

	D9	D8	D7	D6	D5	D4	D3	D2	D1	D0
Data	REG3CTL		PWOFFCTL		CHGISE L	PRCHG OFF	BUZZSEL	SOUND1	SOUND2	SOUND3
Operation at data "1"	REG3ON	REG3OFF	Special poweroff setting	*	Low precision	PRCHG OFF	Loud-speaker Amp. short waveform output	Sounder1 ON	Sounder2 ON	Sounder3 ON
Operation at data "0"	REG3OFF	REG3ON	*	Special poweroff setting	High precision (×8)	PRCHG ON	Loud-speaker Amp. usual output	Sounder1 OFF	Sounder2 OFF	Sounder3 OFF
Initial value after reset	1	0	0	1	0	0	0	0	0	0

*: Unused

A7	A6	A5	A4	A3	A2	A1	A0
1	1	1	1	1	1	0	0

	D9	D8	D7	D6	D5	D4	D3	D2	D1	D0
Data	DAR4_9	DAR4_8	DAR4_7	DAR4_6	DAR4_5	DAR4_4	DAR4_3	DAR4_2	DAR4_1	DAR4_0
Operation at data "1"	DA4 setting data									
Operation at data "0"										
Initial value after reset	0	0	0	0	0	0	0	0	0	0

A7	A6	A5	A4	A3	A2	A1	A0
1	1	1	1	1	0	1	1

	D9	D8	D7	D6	D5	D4	D3	D2	D1	D0
Data	PDNDA4	PDNDA3	DAR3_7	DAR3_6	DAR3_5	DAR3_4	DAR3_3	DAR3_2	DAR3_1	DAR3_0
Operation at data "1"	DA4ON	DA3ON	DA3 setting data							
Operation at data "0"	DA4OFF	DA3OFF								
Initial value after reset	0	0	0	0	0	0	0	0	0	0

A7	A6	A5	A4	A3	A2	A1	A0
1	1	1	1	1	0	1	0

	D9	D8	D7	D6	D5	D4	D3	D2	D1	D0
Data	*	PDNDA2	DAR2_7	DAR2_6	DAR2_5	DAR2_4	DAR2_3	DAR2_2	DAR2_1	DAR2_0
Operation at data "1"	*	DA2ON	DA2 setting data							
Operation at data "0"	*	DA2OFF								
Initial value after reset	*	0	0	0	0	0	0	0	0	0

*:Unused

MB3892

A7	A6	A5	A4	A3	A2	A1	A0
1	1	1	1	1	0	0	1

	D9	D8	D7	D6	D5	D4	D3	D2	D1	D0
Data	*	PDNDA1	DAR1_7	DAR1_6	DAR1_5	DAR1_4	DAR1_3	DAR1_2	DAR1_1	DAR1_0
Operation at data "1"	*	DA1ON	DA1setting data							
Operation at data "0"	*	DA1OFF								
Initial value after reset	*	0	0	0	0	0	0	0	0	0

A7	A6	A5	A4	A3	A2	A1	A0
1	1	1	1	1	0	0	0

	D9	D8	D7	D6	D5	D4	D3	D2	D1	D0
Data	*	*	*	*	*	*	*	REG3CTL	PWOFFCTL	
Operation at data "1"	*	*	*	*	*	*	*	REG3ON	Special power off setting	*
Operation at data "0"	*	*	*	*	*	*	*	REG3OFF	*	Special power off setting
Initial value after reset	*	*	*	*	*	*	*	1	0	1

*:Unused

(2) Input Signal Timing

Parameter	Symbol	Value			Unit	Remark
		Min.	Typ.	Max.		
Data setup time	tsc	100	—	—	ns	
Data hold time	thc	100	—	—	ns	
STB setup time	tss	100	—	—	ns	
STB pulse duration	tds	100	—	—	ns	
Removal time	ths	100	—	—	ns	

(3) Input Signal Timing Diagram

(Input voltage “H” level = 2.85 V, “L” level = 0 V)

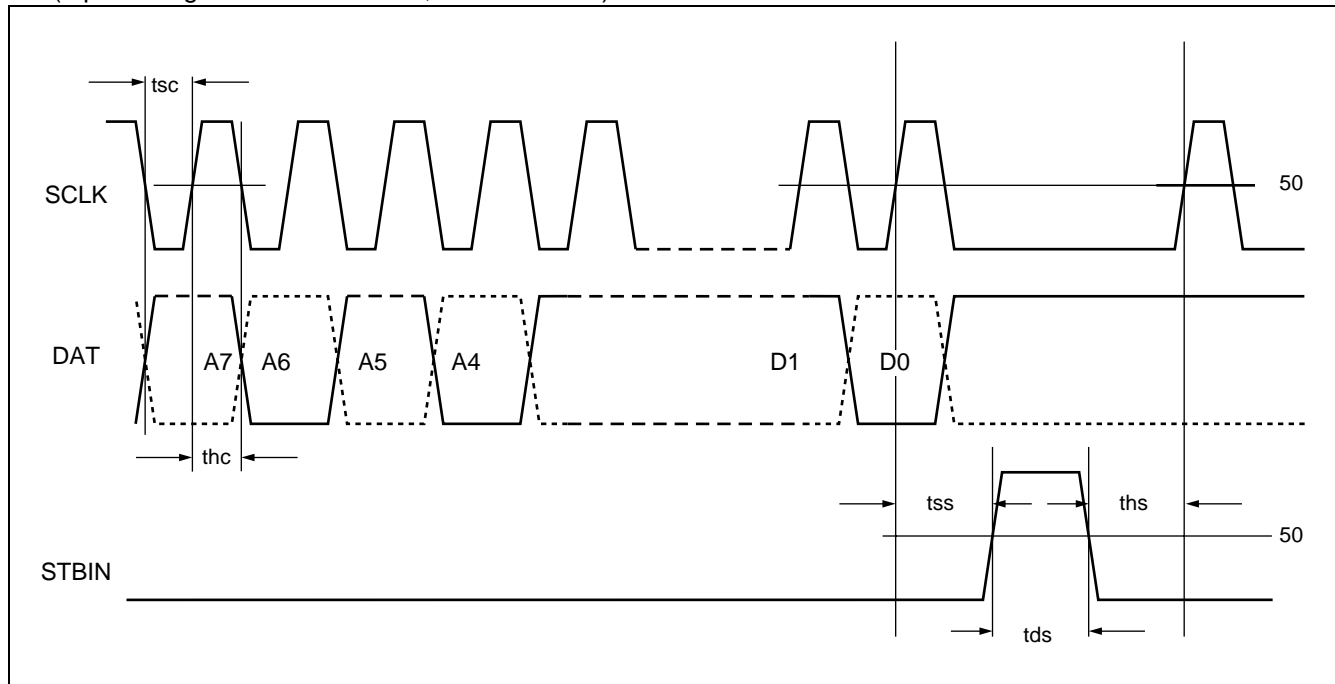

Note : Data is defined at the rising edge of SCLK and IC mode is set through latching of DAT at rising edge STBIN.

POWER-ON RESET TIMING DIAGRAM

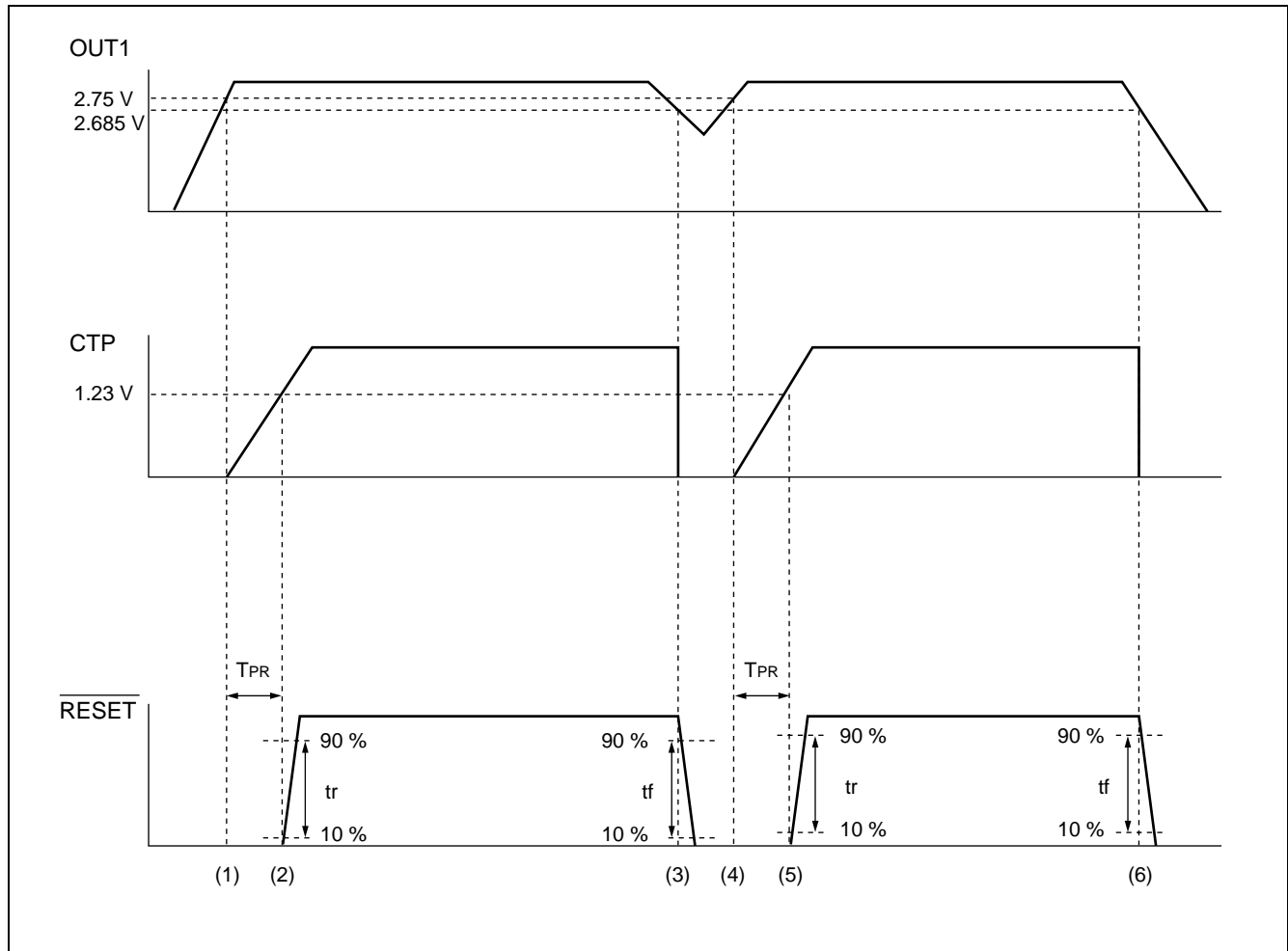

- (1) When the OUT1 terminal (pin 75) voltage exceeds detected rising voltage (2.75V typ.), the charge for timing capacitor (C_{TP}) for hold time for power-on reset starts .
- (2) When the CTP terminal (pin 76) voltage exceeds 1.23V (typ.), the reset is canceled. (The $\overline{\text{RESET}}$ terminal voltage becomes "H" level from "L" level.: rising time from 10% to 90% = t_r)
- (3) When OUT1 terminal voltage falls below detected rising voltage (2.685V typ.), the CTP terminal voltage is down and the reset signal is output. ($\overline{\text{RESET}}$ terminal voltage becomes "L" level from "H" level.)
- (4) When OUT1 terminal voltage exceeds rising voltage detect, charging of C_{TP} is started.
- (5) When CTP terminal voltage rises above threshold voltage, the reset is canceled.
- (6) When OUT1 terminal voltage falls below the voltage detect, the reset signal is output.

SETTING OF HOLD TIME FOR POWER-ON RESET

According to the time constant set by capacitor (C_{TP}) connected to CTP terminal (pin 76), rise time (hold time) of $\overline{\text{RESET}}$ terminal (pin 77) voltage can be set after OUT1 terminal (pin 75) voltage exceeds 2.75V (typ.).

$$\text{POR hold time : } T_{PR} \text{ (s)} \doteq \frac{1.23 \text{ (V)} \times C_{TP} \text{ (\mu F)}}{1.75 \text{ (\mu A)}} \quad (\text{tr of } \overline{\text{RESET}} \text{ is not included)}$$

RISE TIME FOR SPEAKER Amp.

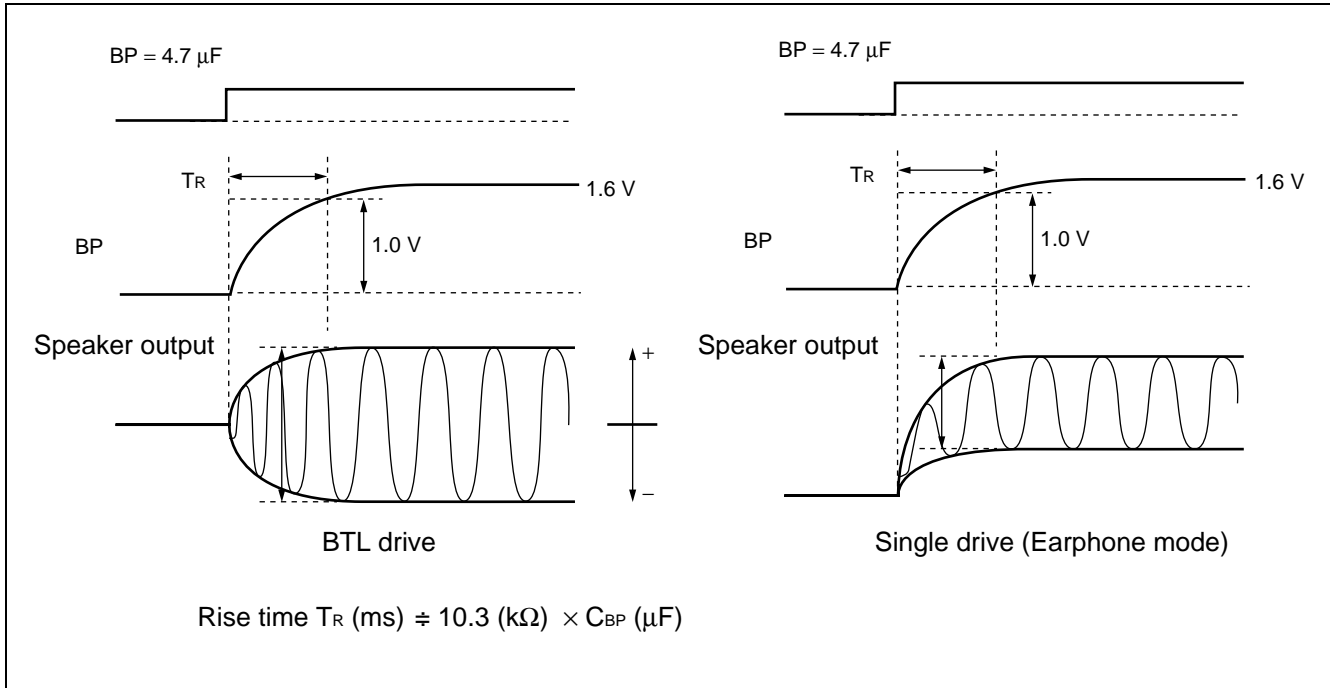

PRELIMINARY CHARGE CURRENT

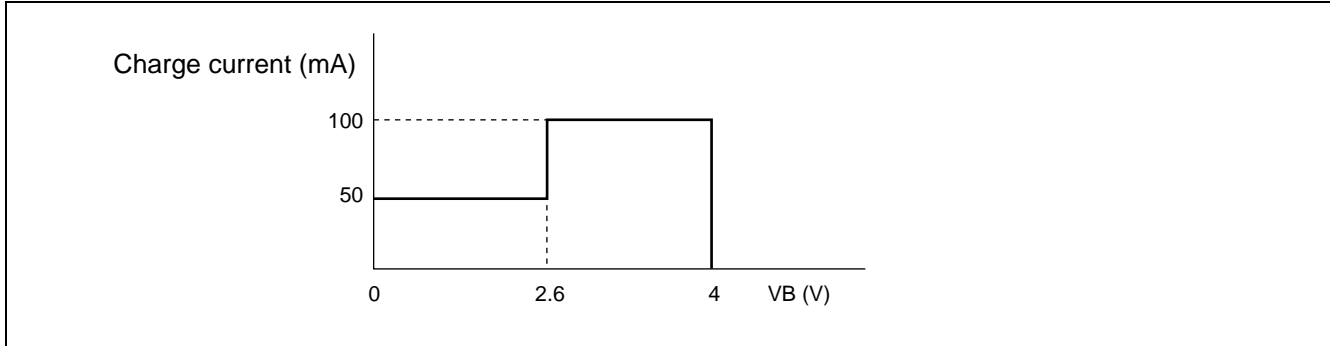

BATTERY VOLTAGE DETECTOR

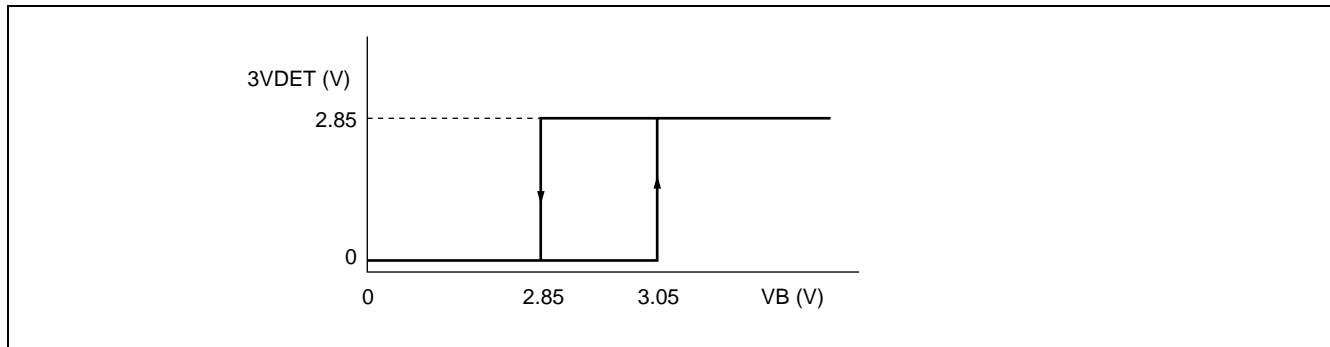

MB3892

■ USAGE PRECAUTIONS

- **Printed circuit board ground lines should be set up with consideration for common impedance.**
- **Take appropriate static electricity measures.**
 - Containers for semiconductor materials should have anti-static protection or be made of conductive material.
 - After mounting, printed circuit boards should be stored and shipped in conductive bags or Containers.
 - Work platforms, tools, and instruments should be properly grounded.
 - Working personal should be grounded with resistance of 250 kΩ to 1 MΩ between body and ground.

• **Do not apply negative voltages**

The use of negative voltages below -0.3V may create parasitic transistors on LSI lines, Which can cause abnormal operation.

■ ORDERING INFORMATION

Part number	Package	Remarks
MB3892PFF	80-pin plastic LQFP (FPT-80P-M17)	

■ PACKAGE DIMENTION

80-pin plastic LQFP
(FPT-80P-M17)

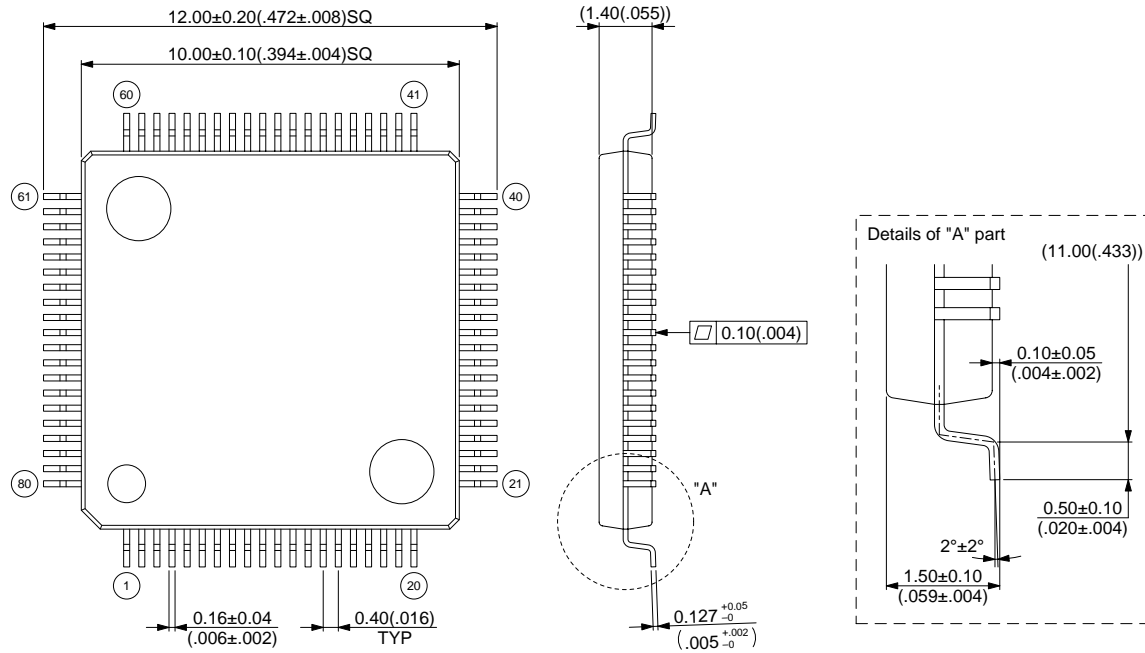

© 1999 FUJITSU LIMITED F80031SC-1-1

Dimansions in mm (inches) .

FUJITSU LIMITED

For further information please contact:

Japan

FUJITSU LIMITED
Corporate Global Business Support Division
Electronic Devices
KAWASAKI PLANT, 4-1-1, Kamikodanaka,
Nakahara-ku, Kawasaki-shi,
Kanagawa 211-8588, Japan
Tel: +81-44-754-3763
Fax: +81-44-754-3329

<http://www.fujitsu.co.jp/>

North and South America

FUJITSU MICROELECTRONICS, INC.
3545 North First Street,
San Jose, CA 95134-1804, U.S.A.
Tel: +1-408-922-9000
Fax: +1-408-922-9179

Customer Response Center
Mon. - Fri.: 7 am - 5 pm (PST)
Tel: +1-800-866-8608
Fax: +1-408-922-9179

<http://www.fujitsumicro.com/>

Europe

FUJITSU MICROELECTRONICS EUROPE GmbH
Am Siebenstein 6-10,
D-63303 Dreieich-Buchsschlag,
Germany
Tel: +49-6103-690-0
Fax: +49-6103-690-122

<http://www.fujitsu-fme.com/>

Asia Pacific

FUJITSU MICROELECTRONICS ASIA PTE. LTD.
#05-08, 151 Lorong Chuan,
New Tech Park,
Singapore 556741
Tel: +65-281-0770
Fax: +65-281-0220

<http://www.fmap.com.sg/>

Korea

FUJITSU MICROELECTRONICS KOREA LTD.
1702 KOSMO TOWER, 1002 Daechi-Dong,
Kangnam-Gu, Seoul 135-280
Korea
Tel: +82-2-3484-7100
Fax: +82-2-3484-7111

F0007

© FUJITSU LIMITED Printed in Japan

All Rights Reserved.

The contents of this document are subject to change without notice. Customers are advised to consult with FUJITSU sales representatives before ordering.

The information and circuit diagrams in this document are presented as examples of semiconductor device applications, and are not intended to be incorporated in devices for actual use. Also, FUJITSU is unable to assume responsibility for infringement of any patent rights or other rights of third parties arising from the use of this information or circuit diagrams.

The contents of this document may not be reproduced or copied without the permission of FUJITSU LIMITED.

FUJITSU semiconductor devices are intended for use in standard applications (computers, office automation and other office equipments, industrial, communications, and measurement equipments, personal or household devices, etc.).

CAUTION:

Customers considering the use of our products in special applications where failure or abnormal operation may directly affect human lives or cause physical injury or property damage, or where extremely high levels of reliability are demanded (such as aerospace systems, atomic energy controls, sea floor repeaters, vehicle operating controls, medical devices for life support, etc.) are requested to consult with FUJITSU sales representatives before such use. The company will not be responsible for damages arising from such use without prior approval.

Any semiconductor devices have inherently a certain rate of failure. You must protect against injury, damage or loss from such failures by incorporating safety design measures into your facility and equipment such as redundancy, fire protection, and prevention of over-current levels and other abnormal operating conditions.

If any products described in this document represent goods or technologies subject to certain restrictions on export under the Foreign Exchange and Foreign Trade Control Law of Japan, the prior authorization by Japanese government should be required for export of those products from Japan.