

Features

- **Fast Read Access Time - 45 ns**
- **Low Power CMOS Operation**
100 μ A max. Standby
20 mA max. Active at 5 MHz
- **Wide Selection of JEDEC Standard Packages**
28-Lead 600-mil PDIP and Cerdip
32-Pad PLCC and LCC
28-Lead TSOP and SOIC
- **5V \pm 10% Supply**
- **High Reliability CMOS Technology**
2,000 V ESD Protection
200 mA Latchup Immunity
- **Rapid Programming - 100 μ s/byte (typical)**
- **Two-Line Control**
- **CMOS and TTL Compatible Inputs and Outputs**
- **Integrated Product Identification Code**
- **Military, Commercial and Industrial Temperature Ranges**

Description

The AT27C256R chip is a low-power, high performance 262,144 bit Ultraviolet Erasable and Electrically Programmable Read Only Memory (EPROM) organized 32K x 8. It requires only one 5 V power supply in normal read mode operation. Any byte can be accessed in less than 45 ns, eliminating the need for speed reducing WAIT states on high performance micro-processor systems.

Atmel's scaled CMOS technology provides low active power consumption, and fast programming. Power consumption is typically only 8 mA in Active Mode and less than 10 μ A in Standby.

(continued)

Pin Configurations

Pin Name	Function
A0-A14	Addresses
O0-O7	Outputs
CE	Chip Enable
OE	Output Enable
NC	No Connect

CDIP, PDIP, SOIC Top

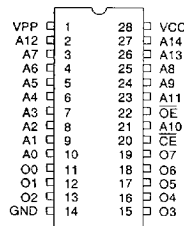

LCC, JLCC, PLCC Top

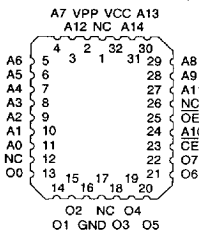

TSOP Top View
Type 1

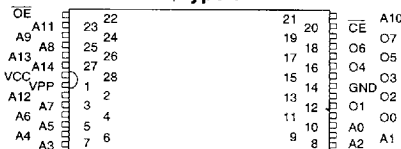

Note: PLCC Package Pins 1 and 17 are DON'T CONNECT.

256K (32K x 8)
UV
Erasable
CMOS
EPROM



1074177 0008128 935



Description (Continued)

The AT27C256R comes in a choice of industry standard JEDEC-approved packages, including: one time programmable (OTP) plastic DIP, PLCC, SOIC, and TSOP, as well as windowed ceramic Cerdip and LCC. All devices feature two-line control (\overline{CE} , \overline{OE}) to give designers the flexibility to prevent bus contention.

With high density 32K byte storage capability, the AT27C256R allows firmware to be stored reliably and to be accessed by the system without the delays of mass storage media.

Atmel's 27C256R has additional features to ensure high quality and efficient production use. The Rapid Programming Algorithm reduces the time required to program the part and guarantees reliable programming. Programming time is typically only 100 μ s/byte. The Integrated Product Identification Code electronically identifies the device and manufacturer. This feature is used by industry standard programming equipment to select the proper programming algorithms and voltages.

Erase Characteristics

The entire memory array of the AT27C256R is erased (all outputs read as V_{OH}) after exposure to ultraviolet light at a wavelength of 2537 \AA . Complete erasure is assured after a minimum of 20 minutes exposure using 12,000 μ W/cm² intensity lamps spaced one inch away from the chip. Minimum erase time for lamps at other intensity ratings can be calculated from the minimum integrated erasure dose of 15 W-sec/cm². To prevent unintentional erasure, an opaque label is recommended to cover the clear window on any UV erasable EPROM which will be subjected to continuous fluorescent indoor lighting or sunlight.

Block Diagram

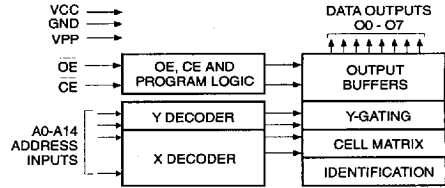

Absolute Maximum Ratings*

Temperature Under Bias	-55°C to +125°C
Storage Temperature.....	-65°C to +150°C
Voltage on Any Pin with Respect to Ground.....	-2.0 V to +7.0 V ⁽¹⁾
Voltage on A9 with Respect to Ground	-2.0 V to +14.0 V ⁽¹⁾
V _{PP} Supply Voltage with Respect to Ground.....	-2.0 V to 14.0 V ⁽¹⁾
Integrated UV Erase Dose.....	7258 W•sec/cm ²

*NOTICE: Stresses beyond those listed under "Absolute Maximum Ratings" may cause permanent damage to the device. This is a stress rating only and functional operation of the device at these or any other conditions beyond those indicated in the operational sections of this specification is not implied. Exposure to absolute maximum rating conditions for extended periods may affect device reliability.

Notes:

1. Minimum voltage is -0.6 V dc which may undershoot to -2.0 V for pulses of less than 20 ns. Maximum output pin voltage is $V_{CC}+0.75$ V dc which may overshoot to +7.0 V for pulses of less than 20 ns.

Operating Modes

Mode \ Pin	\overline{CE}	\overline{OE}	Ai	V _{PP}	V _{CC}	Outputs
Read	V _{IL}	V _{IL}	Ai	V _{CC}	V _{CC}	DOUT
Output Disable	V _{IL}	V _{IH}	X ⁽¹⁾	V _{CC}	V _{CC}	High Z
Standby	V _{IH}	X	X	V _{CC}	V _{CC}	High Z
Rapid Program ⁽²⁾	V _{IL}	V _{IH}	Ai	V _{PP}	V _{CC}	DIN
PGM Verify ⁽²⁾	X	V _{IL}	Ai	V _{PP}	V _{CC}	DOUT
Optional PGM Verify ⁽²⁾	V _{IL}	V _{IL}	Ai	V _{CC}	V _{CC}	DOUT
PGM Inhibit ⁽²⁾	V _{IH}	V _{IH}	X	V _{PP}	V _{CC}	High Z
Product Identification ⁽⁴⁾	V _{IL}	V _{IL}	A9=V _H ⁽³⁾ A0=V _{IH} or V _{IL} A1-A14=V _{IL}	V _{CC}	V _{CC}	Identification Code

- Notes: 1. X can be V_{IL} or V_{IH}.
2. Refer to Programming characteristics.
3. V_H = 12.0 \pm 0.5 V.

4. Two identifier bytes may be selected. All Ai inputs are held low (V_{IL}), except A9 which is set to V_H and A0 which is toggled low (V_{IL}) to select the Manufacturer's Identification byte and high (V_{IH}) to select the Device Code byte.

D.C. and A.C. Operating Conditions for Read Operation

		AT27C256R					
		-45	-55	-70	-90	-12	-15
Operating Temp. (Case)	Com.	0°C - 70°C	0°C - 70°C	0°C - 70°C	0°C - 70°C	0°C - 70°C	0°C - 70°C
	Ind.	-40°C - 85°C	-40°C - 85°C	-40°C - 85°C	-40°C - 85°C	-40°C - 85°C	-40°C - 85°C
	Mil.			-55°C - 125°C	-55°C - 125°C	-55°C - 125°C	-55°C - 125°C
V _{CC} Supply		5 V ± 10%	5 V ± 10%	5 V ± 10%	5 V ± 10%	5 V ± 10%	5 V ± 10%

[Shaded Box] = Advance Information

3

D.C. and Operating Characteristics for Read Operation

Symbol	Parameter	Condition	Min	Max	Units
I _{LI}	Input Load Current	V _{IN} = 0 V to V _{CC}	Com., Ind.	±1	μA
			Mil.	±5	μA
I _{LO}	Output Leakage Current	V _{OUT} = 0 V to V _{CC}	Com., Ind.	±5	μA
			Mil.	±10	μA
I _{PP1} (2)	V _{PP} (1) Read/Standby Current	V _{PP} = V _{CC}		10	μA
I _{SB}	V _{CC} (1) Standby Current	I _{SB1} (CMOS), $\overline{CE} = V_{CC} \pm 0.3$ V		100	μA
		I _{SB2} (TTL), $\overline{CE} = 2.0$ to V _{CC} +0.5 V		1	mA
I _{CC}	V _{CC} Active Current	f = 5 MHz, I _{OUT} = 0 mA, $\overline{CE} = V_{IL}$	Com.	20	mA
			Ind., Mil.	25	mA
V _{IL}	Input Low Voltage		-0.6	0.8	V
V _{IH}	Input High Voltage		2.0	V _{CC} +0.5	V
V _{OL}	Output Low Voltage	I _{OL} = 2.1 mA		.45	V
		I _{OH} = -100 μA		V _{CC} -0.3	V
V _{OH}	Output High Voltage	I _{OH} = -2.5 mA		3.5	V
		I _{OH} = -400 μA		2.4	V

Notes: 1. V_{CC} must be applied simultaneously or before V_{PP}, and removed simultaneously or after V_{PP}.
 2. V_{PP} may be connected directly to V_{CC}, except during programming. The supply current would then be the sum of I_{CC} and I_{PP}.

A.C. Characteristics for Read Operation

				AT27C256R												
				-45		-55		-70		-90		-12		-15		Units
Symbol	Parameter	Condition		Min	Max	Min	Max	Min	Max	Min	Max	Min	Max	Min	Max	
t _{ACC} (3)	Address to Output Delay	$\overline{CE} = \overline{OE} = V_{IL}$	Com., Ind.	45		55		70		90		120		150		ns
				Mil.					70		90		120		150	
t _{CE} (2)	\overline{CE} to Output Delay	$\overline{OE} = V_{IL}$	45		55		70		90		120		150		ns	
t _{OE} (2,3)	\overline{OE} to Output Delay	$\overline{CE} = V_{IL}$	20		25		30		30		35		40		ns	
t _{DF} (4,5)	\overline{OE} or \overline{CE} High to Output Float			20		20		25		25		30		35		ns
t _{OH}	Output Hold from Address, \overline{CE} or \overline{OE} , whichever occurred first			7		7		7		0		0		0		ns

Notes: 2, 3, 4, 5. - see AC Waveforms for Read Operation.

[Shaded Box] = Advance Information



A.C. Waveforms for Read Operation ⁽¹⁾

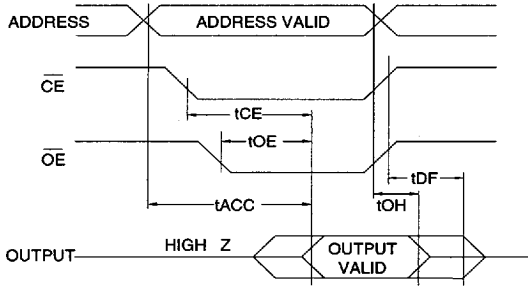

Notes:

1. Timing measurement references are 0.8 V and 2.0 V. Input AC driving levels are 0.45 V and 2.4 V, unless otherwise specified. Timing measurement reference is 1.5 V for -45 and -55 parts. Input AC driving levels are 0.0 V and 3.0 V for -45 and -55 parts, unless otherwise specified.
2. \overline{OE} may be delayed up to t_{CE-tOE} after the falling edge of \overline{CE} without impact on t_{CE} .
3. \overline{OE} may be delayed up to $t_{ACC-tOE}$ after the address is valid without impact on t_{ACC} .
4. This parameter is only sampled and is not 100% tested.
5. Output float is defined as the point when data is no longer driven.

Input Test Waveforms and Measurement Levels

For -45 and -55 devices only:

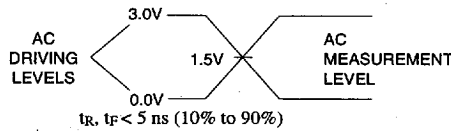

For -70, -90, -12, and -15 devices:

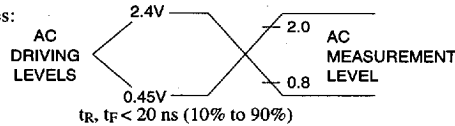

Output Test Load

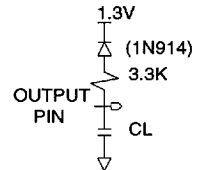

Note: $C_L = 100$ pF including jig capacitance, except for the -45 and -55 devices, where $C_L = 30$ pF.

Pin Capacitance ($f = 1\text{MHz}$, $T = 25^\circ\text{C}$) ⁽¹⁾

	Typ	Max	Units	Conditions
C_{IN}	4	6	pF	$V_{IN} = 0$ V
C_{OUT}	8	12	pF	$V_{OUT} = 0$ V

Notes: 1. Typical values for nominal supply voltage. This parameter is only sampled and is not 100% tested.

Programming Waveforms ⁽¹⁾

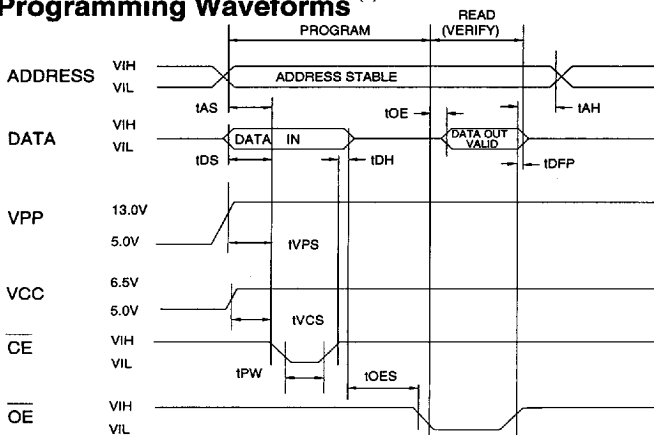

Notes:

1. The Input Timing Reference is 0.8 V for V_{IL} and 2.0 V for V_{IH} .
2. t_{OE} and t_{DFP} are characteristics of the device but must be accommodated by the programmer.
3. When programming the AT27C256R a 0.1- μF capacitor is required across V_{PP} and ground to suppress spurious voltage transients.

D.C. Programming Characteristics

$T_A = 25 \pm 5^\circ\text{C}$, $V_{CC} = 6.5 \pm 0.25\text{ V}$, $V_{PP} = 13.0 \pm 0.25\text{ V}$

Sym- bol	Parameter	Test Conditions	Limits		Units
			Min	Max	
I _{LI}	Input Load Current	$V_{IN}=V_{IL}, V_{IH}$		10	μA
V _{IL}	Input Low Level	(All Inputs)	-0.6	0.8	V
V _{IH}	Input High Level		2.0	$V_{CC} + 1$	V
V _{OL}	Output Low Volt.	$I_{OL}=2.1\text{ mA}$.45	V
V _{OH}	Output High Volt.	$I_{OH}=-400\ \mu\text{A}$	2.4		V
I _{CC2}	V _{CC} Supply Current (Program and Verify)			25	mA
I _{PP2}	V _{PP} Current	$\overline{CE}=V_{IL}$		25	mA
V _{ID}	A9 Product Identification Voltage		11.5	12.5	V

A.C. Programming Characteristics

$T_A = 25 \pm 5^\circ\text{C}$, $V_{CC} = 6.5 \pm 0.25\text{ V}$, $V_{PP} = 13.0 \pm 0.25\text{ V}$

Sym- bol	Parameter	Test Conditions* (see Note 1)	Limits		Units
			Min	Max	
t _{AS}	Address Setup Time		2		μs
t _{OES}	\overline{OE} Setup Time		2		μs
t _{DS}	Data Setup Time		2		μs
t _{AH}	Address Hold Time		0		μs
t _{DH}	Data Hold Time		2		μs
t _{DFP}	\overline{OE} High to Out- put Float Delay	(Note 2)	0	130	ns
t _{VPS}	V _{PP} Setup Time		2		μs
t _{VCS}	V _{CC} Setup Time		2		μs
t _{PW}	\overline{CE} Program Pulse Width	(Note 3)	95	105	μs
t _{OE}	Data Valid from \overline{OE}	(Note 2)		150	ns

*A.C. Conditions of Test:

- Input Rise and Fall Times (10% to 90%) 20 ns
- Input Pulse Levels 0.45 V to 2.4 V
- Input Timing Reference Level 0.8 V to 2.0 V
- Output Timing Reference Level 0.8 V to 2.0 V

Notes:

1. V_{CC} must be applied simultaneously or before V_{PP} and removed simultaneously or after V_{PP}.
2. This parameter is only sampled and is not 100% tested. Output Float is defined as the point where data is no longer driven — see timing diagram.
3. Program Pulse width tolerance is 100 $\mu\text{sec} \pm 5\%$.

Atmel's 27C256R Integrated Product Identification Code

Codes	Pins								Hex Data	
	A0	O7	O6	O5	O4	O3	O2	O1		O0
Manufacturer	0	0	0	0	1	1	1	1	0	1E
Device Type	1	1	0	0	0	1	1	0	0	8C

3

Rapid Programming Algorithm

A 100 μs \overline{CE} pulse width is used to program. The address is set to the first location. V_{CC} is raised to 6.5 V and V_{PP} is raised to 13.0 V. Each address is first programmed with one 100 μs \overline{CE} pulse without verification. Then a verification/reprogramming loop is executed for each address. In the event a byte fails to pass verification, up to 10 successive 100 μs pulses are applied with a verification after each pulse. If the byte fails to verify after 10 pulses have been applied, the part is considered failed. After the byte verifies properly, the next address is selected until all have been checked. V_{PP} is then lowered to 5.0 V and V_{CC} to 5.0 V. All bytes are read again and compared with the original data to determine if the device passes or fails.

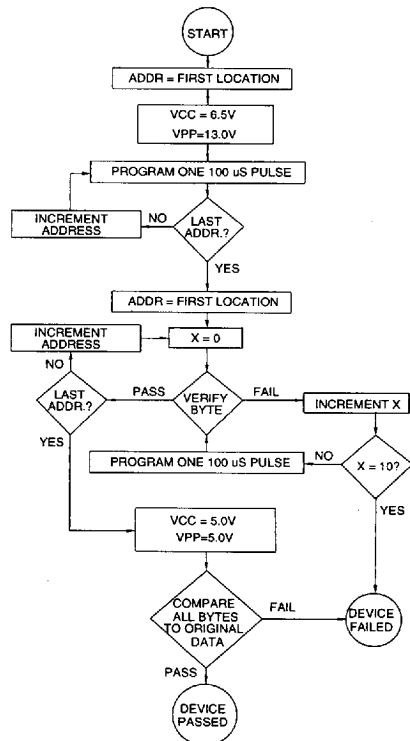

1074177 0008132 366



Ordering Information

 = Advance Information

tACC (ns)	Icc (mA)		Ordering Code	Package	Operation Range
	Active	Standby			
45	20	0.1	AT27C256R-45DC AT27C256R-45JC AT27C256R-45LC AT27C256R-45PC AT27C256R-45RC AT27C256R-45TC	28DW6 32J 32LW 28P6 28R 28T	Commercial (0°C to 70°C)
45	25	0.1	AT27C256R-45DI AT27C256R-45JI AT27C256R-45LI AT27C256R-45PI AT27C256R-45RI AT27C256R-45TI	28DW6 32J 32LW 28P6 28R 28T	Industrial (-40°C to 85°C)
55	20	0.1	AT27C256R-55DC AT27C256R-55JC AT27C256R-55KC AT27C256R-55LC AT27C256R-55PC AT27C256R-55RC AT27C256R-55TC	28DW6 32J 32KW 32LW 28P6 28R 28T	Commercial (0°C to 70°C)
55	25	0.1	AT27C256R-55DI AT27C256R-55JI AT27C256R-55KI AT27C256R-55LI AT27C256R-55PI AT27C256R-55RI AT27C256R-55TI	28DW6 32J 32KW 32LW 28P6 28R 28T	Industrial (-40°C to 85°C)
70	20	0.1	AT27C256R-70DC AT27C256R-70JC AT27C256R-70KC AT27C256R-70LC AT27C256R-70PC AT27C256R-70RC AT27C256R-70TC	28DW6 32J 32KW 32LW 28P6 28R 28T	Commercial (0°C to 70°C)
70	25	0.1	AT27C256R-70DI AT27C256R-70JI AT27C256R-70KI AT27C256R-70LI AT27C256R-70PI AT27C256R-70RI AT27C256R-70TI	28DW6 32J 32KW 32LW 28P6 28R 28T	Industrial (-40°C to 85°C)
			AT27C256R-70DM AT27C256R-70KM AT27C256R-70LM	28DW6 32KW 32LW	Military (-55°C to 125°C)
			AT27C256R-70DM/883 AT27C256R-70KM/883 AT27C256R-70LM/883	28DW6 32KW 32LW	Military/883C Class B, Fully Compliant (-55°C to 125°C)

Ordering Information

tACC (ns)	Icc (mA)		Ordering Code	Package	Operation Range
	Active	Standby			
90	20	0.1	AT27C256R-90DC AT27C256R-90JC AT27C256R-90KC AT27C256R-90LC AT27C256R-90PC AT27C256R-90RC AT27C256R-90TC	28DW6 32J 32KW 32LW 28P6 28R 28T	Commercial (0°C to 70°C)
90	25	0.1	AT27C256R-90DI AT27C256R-90JI AT27C256R-90KI AT27C256R-90LI AT27C256R-90PI AT27C256R-90RI AT27C256R-90TI	28DW6 32J 32KW 32LW 28P6 28R 28T	Industrial (-40°C to 85°C)
			AT27C256R-90DM AT27C256R-90KM AT27C256R-90LM	28DW6 32KW 32LW	Military (-55°C to 125°C)
			AT27C256R-90DM/883 AT27C256R-90KM/883 AT27C256R-90LM/883	28DW6 32KW 32LW	Military/883C Class B, Fully Compliant (-55°C to 125°C)
120	20	0.1	AT27C256R-12DC AT27C256R-12JC AT27C256R-12KC AT27C256R-12LC AT27C256R-12PC AT27C256R-12RC AT27C256R-12TC	28DW6 32J 32KW 32LW 28P6 28R 28T	Commercial (0°C to 70°C)
120	25	0.1	AT27C256R-12DI AT27C256R-12JI AT27C256R-12KI AT27C256R-12LI AT27C256R-12PI AT27C256R-12RI AT27C256R-12TI	28DW6 32J 32KW 32LW 28P6 28R 28T	Industrial (-40°C to 85°C)
			AT27C256R-12DM AT27C256R-12KM AT27C256R-12LM	28DW6 32KW 32LW	Military (-55°C to 125°C)
			AT27C256R-12DM/883 AT27C256R-12KM/883 AT27C256R-12LM/883	28DW6 32KW 32LW	Military/883C Class B, Fully Compliant (-55°C to 125°C)
150	20	0.1	AT27C256R-15DC AT27C256R-15JC AT27C256R-15KC AT27C256R-15LC AT27C256R-15PC AT27C256R-15RC AT27C256R-15TC	28DW6 32J 32KW 32LW 28P6 28R 28T	Commercial (0°C to 70°C)

3



1074177 0008134 139



Ordering Information

t _{ACC} (ns)	I _{CC} (mA)		Ordering Code	Package	Operation Range
	Active	Standby			
150	25	0.1	AT27C256R-15DI AT27C256R-15JI AT27C256R-15KI AT27C256R-15LI AT27C256R-15PI AT27C256R-15RI AT27C256R-15TI	28DW6 32J 32KW 32LW 28P6 28R 28T	Industrial (-40°C to 85°C)
			AT27C256R-15DM AT27C256R-15KM AT27C256R-15LM	28DW6 32KW 32LW	Military (-55°C to 125°C)
			AT27C256R-15DM/883 AT27C256R-15KM/883 AT27C256R-15LM/883	28DW6 32KW 32LW	Military/883C Class B, Fully Compliant (-55°C to 125°C)
70	25	0.2	5962-86063 08 XX 5962-86063 08 YX 5962-86063 08 ZX	28DW6 32LW 32KW	Military/883C Class B, Fully Compliant (-55°C to 125°C)
90	25	0.2	5962-86063 07 XX 5962-86063 07 YX 5962-86063 07 ZX	28DW6 32LW 32KW	Military/883C Class B, Fully Compliant (-55°C to 125°C)
120	25	0.2	5962-86063 06 XX 5962-86063 06 YX 5962-86063 06 ZX	28DW6 32LW 32KW	Military/883C Class B, Fully Compliant (-55°C to 125°C)
150	25	0.2	5962-86063 05 XX 5962-86063 05 YX 5962-86063 05 ZX	28DW6 32LW 32KW	Military/883C Class B, Fully Compliant (-55°C to 125°C)
170	25	0.2	5962-86063 04 XX 5962-86063 04 YX 5962-86063 04 ZX	28DW6 32LW 32KW	Military/883C Class B, Fully Compliant (-55°C to 125°C)
200	25	0.2	5962-86063 01 XX 5962-86063 01 YX 5962-86063 01 ZX	28DW6 32LW 32KW	Military/883C Class B, Fully Compliant (-55°C to 125°C)
250	25	0.2	5962-86063 02 XX 5962-86063 02 YX 5962-86063 02 ZX	28DW6 32LW 32KW	Military/883C Class B, Fully Compliant (-55°C to 125°C)

Package Type

28DW6	28 Lead, 0.600" Wide, Windowed, Ceramic Dual Inline Package (Cerdip)
32J	32 Lead, Plastic J-Leaded Chip Carrier OTP (PLCC)
32KW	32 Lead, Windowed, Ceramic J-Leaded Chip Carrier (JLCC)
32LW	32 Pad, Windowed, Ceramic Leadless Chip Carrier (LCC)
28P6	28 Lead, 0.600" Wide, Plastic Dual Inline Package OTP (PDIP)
28R	28 Lead, 0.330" Wide, Plastic Gull Wing Small Outline OTP (SOIC)
28T	28 Lead, Plastic Thin Small Outline Package OTP (TSOP)

3-84

AT27C256R

1074177 0008135 075