

Silicon Diffused Power Transistor

BUJ100

GENERAL DESCRIPTION

High-voltage, high-speed planar-passivated npn power switching transistor in the TO92 envelope intended for use in compact fluorescent lamps and low power electronic lighting ballasts, converters and inverters, etc.

QUICK REFERENCE DATA

SYMBOL	PARAMETER	CONDITIONS	TYP.	MAX.	UNIT
V_{CESM}	Collector-emitter voltage peak value	$V_{BE} = 0\text{ V}$	-	700	V
V_{CBO}	Collector-Base voltage (open emitter)		-	700	V
V_{CEO}	Collector-emitter voltage (open base)		-	400	V
I_C	Collector current (DC)		-	1.0	A
I_{CM}	Collector current peak value		-	2.0	A
P_{tot}	Total power dissipation	$T_{lead} \leq 25\text{ }^\circ\text{C}$	-	2	W
V_{CEsat}	Collector-emitter saturation voltage	$I_C = 0.75\text{ A}; I_B = 150\text{ mA}$	0.24	1.0	V
h_{FE}		$I_C = 0.75\text{ A}; V_{CE} = 5\text{ V}$	14	20	
t_{fi}	Fall time (Inductive)	$I_C = 1.0\text{ A}; I_{BON} = 200\text{ mA}$	50	70	ns

PINNING - TO92

PIN	DESCRIPTION
1	Emitter
2	Collector
3	Base

PIN CONFIGURATION

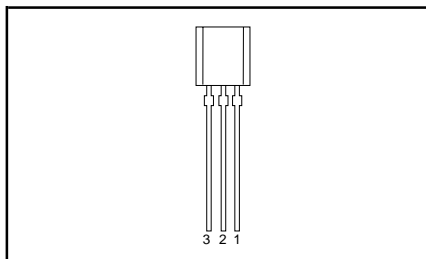

SYMBOL

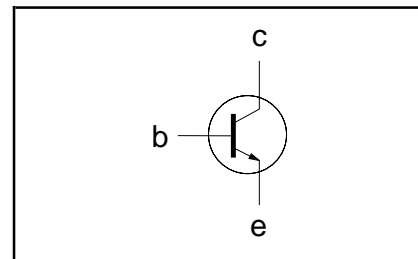

LIMITING VALUES

Limiting values in accordance with the Absolute Maximum Rating System (IEC 134)

SYMBOL	PARAMETER	CONDITIONS	MIN.	MAX.	UNIT
V_{CESM}	Collector to emitter voltage	$V_{BE} = 0\text{ V}$	-	700	V
V_{CEO}	Collector to emitter voltage (open base)		-	400	V
V_{CBO}	Collector to base voltage (open emitter)		-	700	V
I_C	Collector current (DC)		-	1.0	A
I_{CM}	Collector current peak value		-	2.0	A
I_B	Base current (DC)		-	0.5	A
I_{BM}	Base current peak value		-	1.0	A
P_{tot}	Total power dissipation	$T_{lead} \leq 25\text{ }^\circ\text{C}$	-	2	W
T_{stg}	Storage temperature		-65	150	$^\circ\text{C}$
T_j	Junction temperature		-	150	$^\circ\text{C}$

THERMAL RESISTANCES

SYMBOL	PARAMETER	CONDITIONS	TYP.	MAX.	UNIT
$R_{th\ j-lead}$	Thermal resistance junction to lead		-	60	K/W
$R_{th\ j-a}$	Thermal resistance Junction to ambient	pcb mounted; lead length = 4mm	150	-	K/W

Silicon Diffused Power Transistor

BUJ100

STATIC CHARACTERISTICS $T_{\text{lead}} = 25\text{ }^{\circ}\text{C}$ unless otherwise specified

SYMBOL	PARAMETER	CONDITIONS	MIN.	TYP.	MAX.	UNIT
$I_{\text{CES}}, I_{\text{CBO}}$ I_{CES}	Collector cut-off current ¹	$V_{\text{BE}} = 0\text{ V}; V_{\text{CE}} = V_{\text{CESMmax}}$ $V_{\text{BE}} = 0\text{ V}; V_{\text{CE}} = V_{\text{CESMmax}}$ $T_j = 125\text{ }^{\circ}\text{C}$	-	0.8 2.0	100 500	μA μA
I_{CEO}	Collector cut-off current	$V_{\text{CEO}} = V_{\text{CEOMmax}} (400\text{V})$	-	-	100	μA
I_{EBO}	Emitter cut-off current	$V_{\text{EB}} = 9\text{ V}; I_{\text{C}} = 0\text{ A}$	-	0.05	100	μA
$V_{\text{CEO sust}}$	Collector-emitter sustaining voltage	$I_{\text{B}} = 0\text{ A}; I_{\text{C}} = 10\text{mA};$ $L = 25\text{ mH}$	400	-	-	V
V_{CEsat}	Collector-emitter saturation voltage	$I_{\text{C}} = 0.75\text{ A}; I_{\text{B}} = 0.15\text{ A}$	-	0.24	1.0	V
V_{BEsat}	Base-emitter saturation voltage	$I_{\text{C}} = 0.75\text{ A}; I_{\text{B}} = 0.15\text{ A}$	-	0.93	1.3	V
h_{FE}	DC current gain	$I_{\text{C}} = 10\text{mA}; V_{\text{CE}} = 5\text{ V}$	11	20	27	
h_{FE}		$I_{\text{C}} = 100\text{mA}; V_{\text{CE}} = 5\text{ V}$	12.5	21	31	
h_{FE}		$I_{\text{C}} = 0.75\text{ A}; V_{\text{CE}} = 5\text{ V}$	9	14	20	

DYNAMIC CHARACTERISTICS $T_{\text{lead}} = 25\text{ }^{\circ}\text{C}$ unless otherwise specified

SYMBOL	PARAMETER	CONDITIONS	TYP.	MAX.	UNIT
	Switching times (resistive load)	$I_{\text{Con}} = 1.0\text{ A}; I_{\text{Bon}} = -I_{\text{Boff}} = 200\text{mA};$ $R_{\text{L}} = 75\text{ ohms}; V_{\text{BB2}} = 4\text{ V};$			
t_{on}	Turn-on time		0.65	0.88	μs
t_{s}	Turn-off storage time		0.88	1.2	μs
t_{f}	Turn-off fall time		250	338	ns
	Switching times (inductive load)	$I_{\text{Con}} = 1.0\text{ A}; I_{\text{Bon}} = 200\text{mA}; L_{\text{B}} = 1\text{ }\mu\text{H};$ $-V_{\text{BB}} = 5\text{ V}$			
t_{s}	Turn-off storage time		0.51	0.7	μs
t_{f}	Turn-off fall time		50	70	ns
	Switching times (inductive load)	$I_{\text{Con}} = 1.0\text{ A}; I_{\text{Bon}} = 200\text{mA}; L_{\text{B}} = 1\text{ }\mu\text{H};$ $-V_{\text{BB}} = 5\text{ V}; T_j = 100\text{ }^{\circ}\text{C}$			
t_{s}	Turn-off storage time		-	1.4	μs
t_{f}	Turn-off fall time		-	130	ns

¹ Measured with half sine-wave voltage (curve tracer).

Silicon Diffused Power Transistor

BUJ100

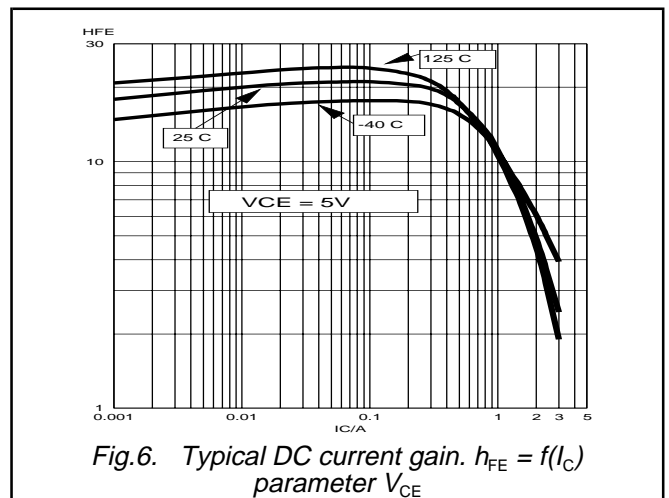
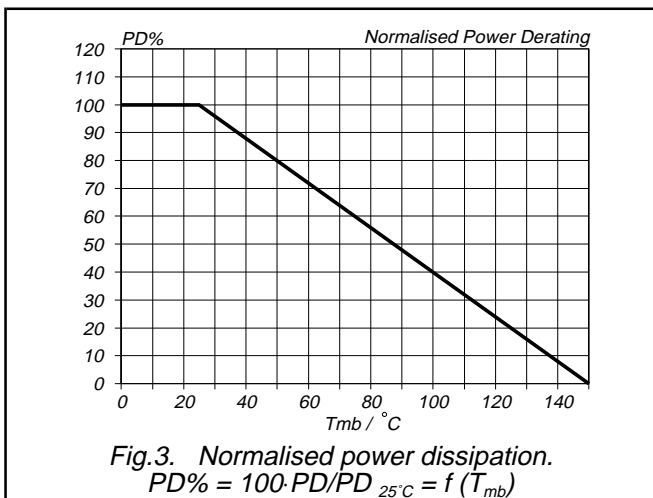
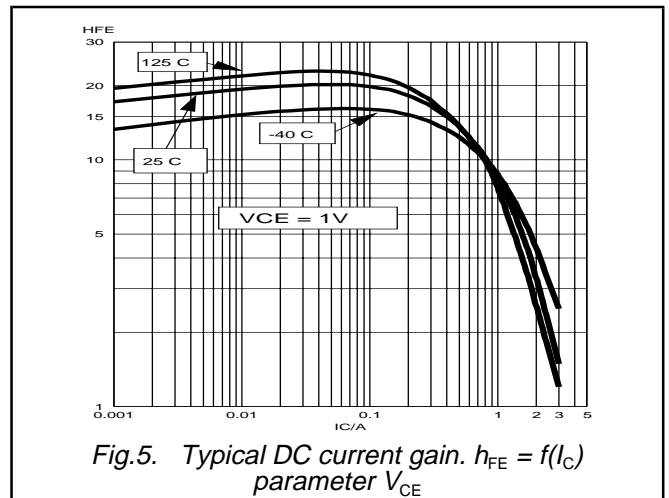
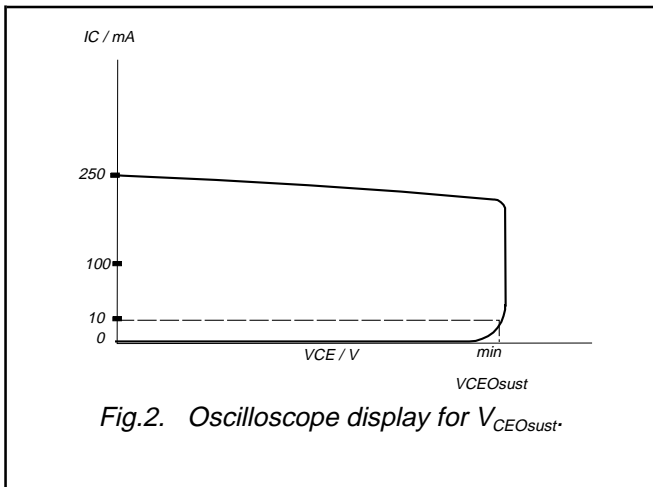
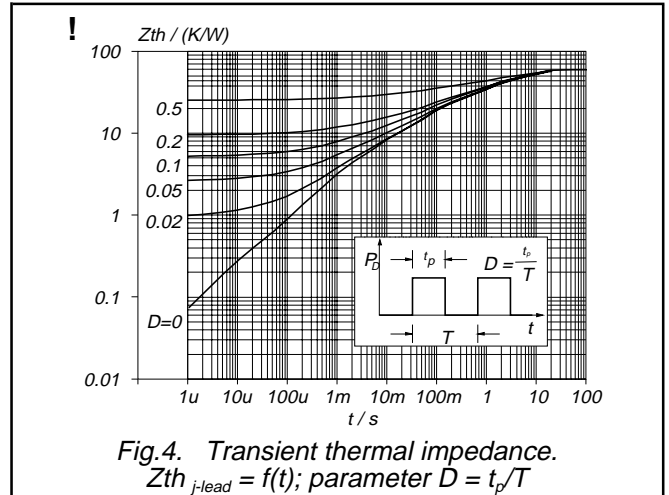
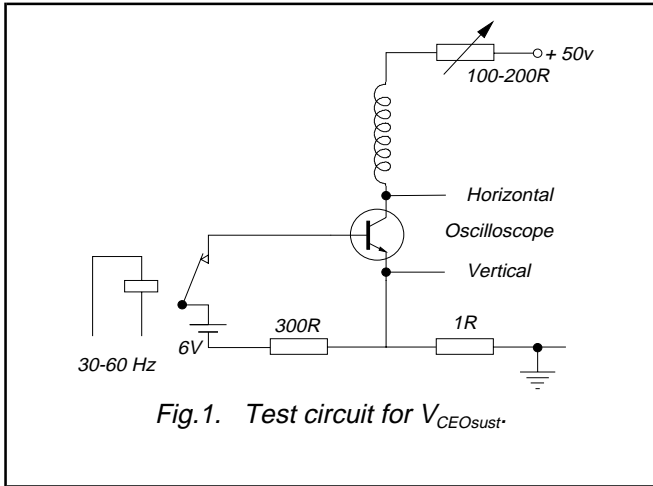

Silicon Diffused Power Transistor

BUJ100

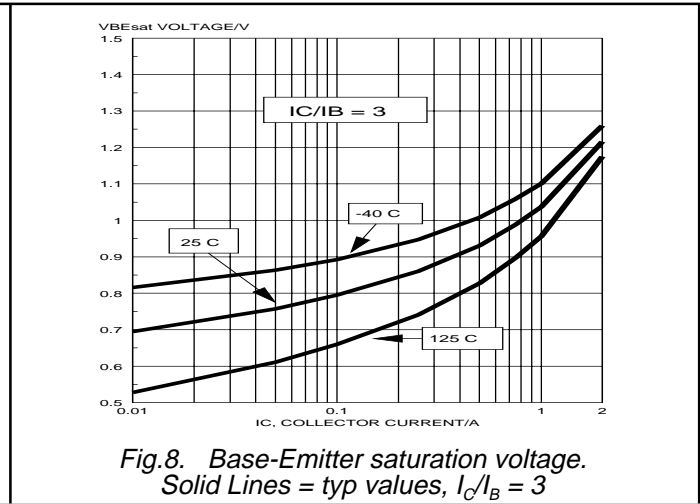
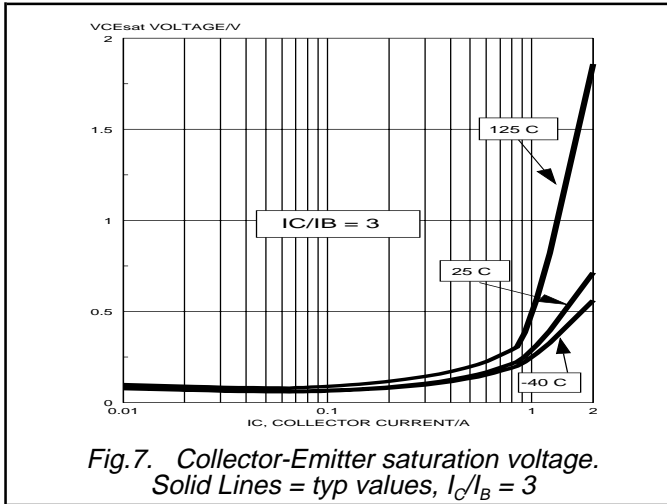

INDUCTIVE SWITCHING

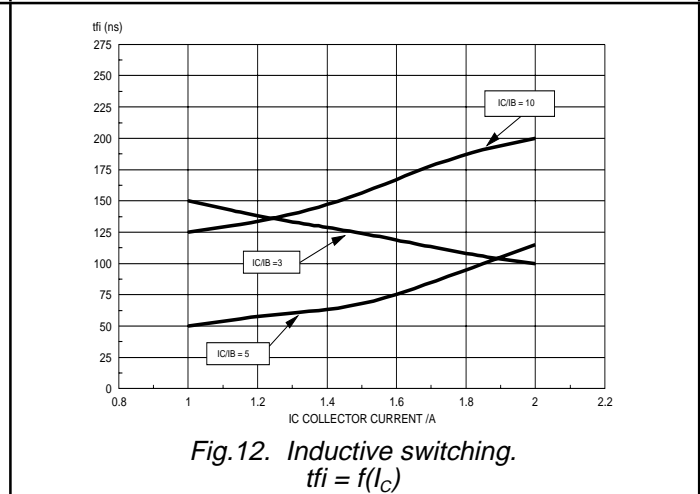
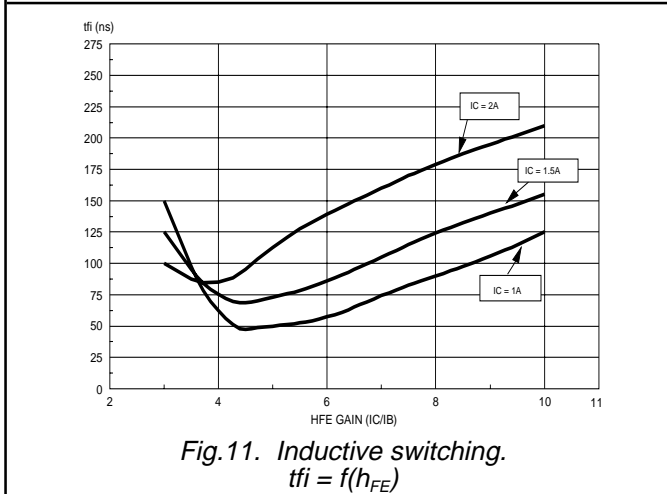
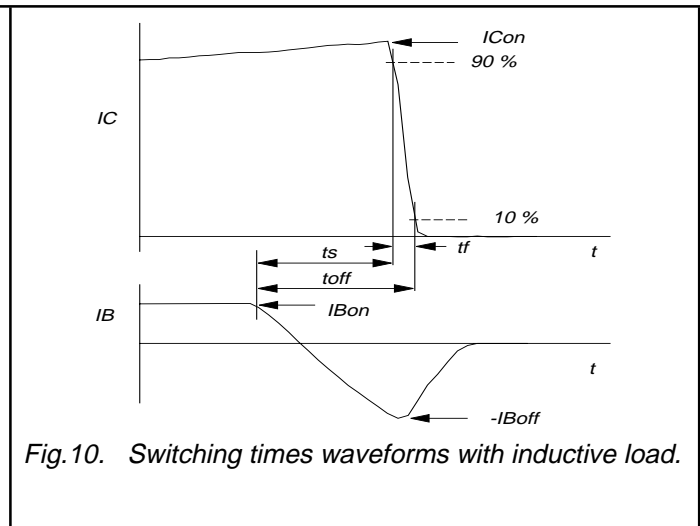
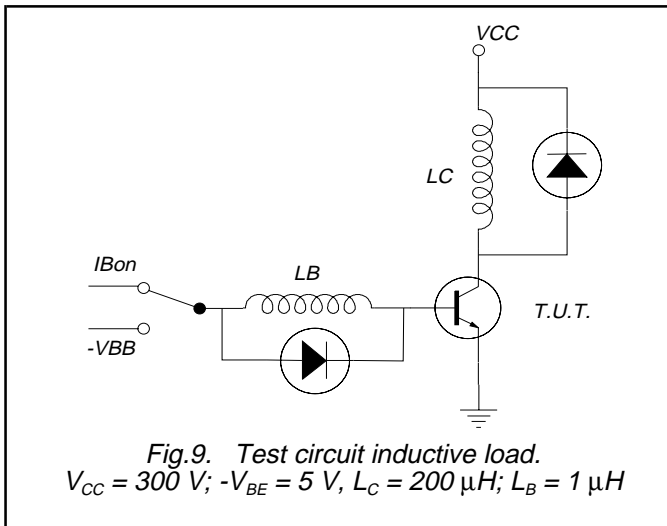

Silicon Diffused Power Transistor

BUJ100

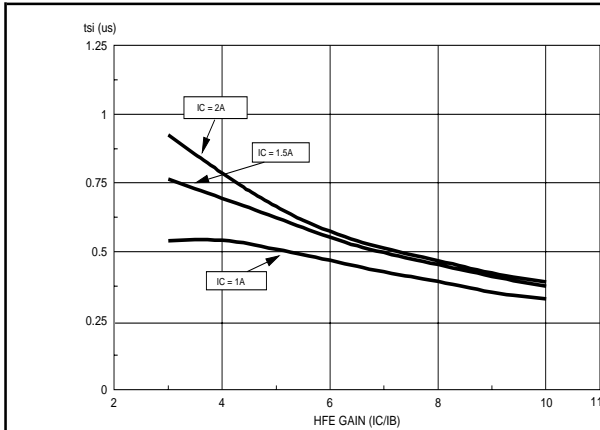

Fig.13. Inductive switching.
 $t_{si} = f(h_{FE})$

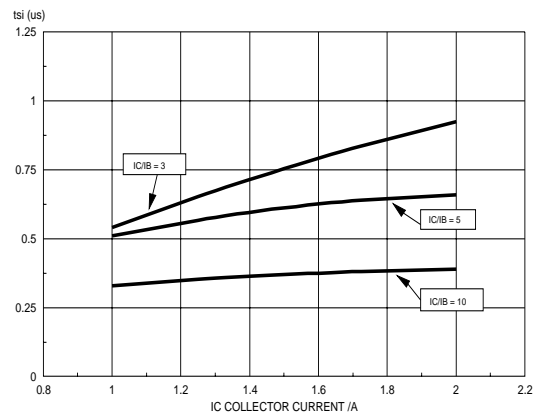

Fig.14. Inductive switching.
 $t_{si} = f(I_C)$

RESISTIVE SWITCHING

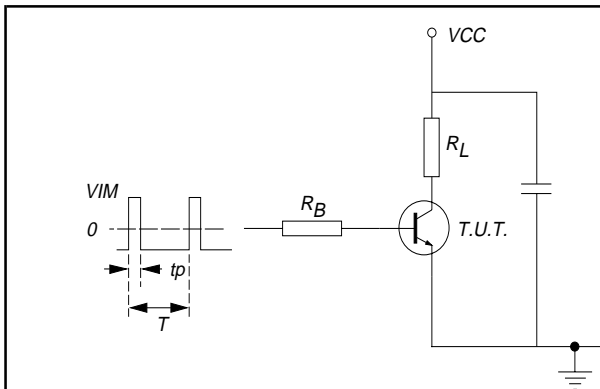

Fig.15. Test circuit resistive load. $V_{IM} = -6$ to $+8$ V
 $V_{CC} = 250$ V; $t_p = 20$ μ s; $\delta = t_p / T = 0.01$.
 R_B and R_L calculated from I_{Con} and I_{Bon} requirements.

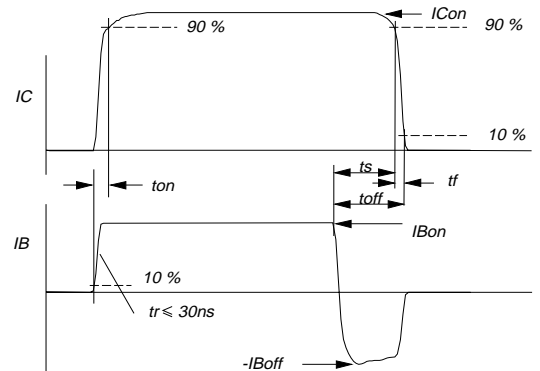

Fig.16. Switching times waveforms with resistive load.

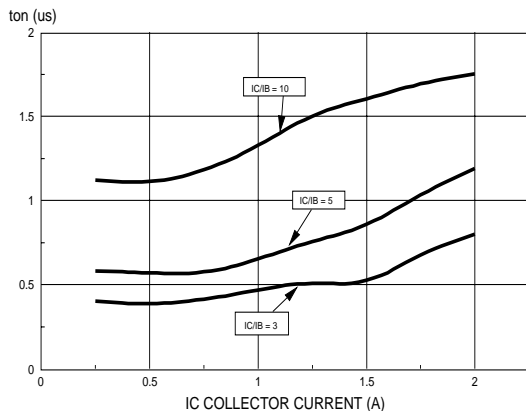

Fig.17. Resistive switching.
 $t_{on} = f(I_C)$

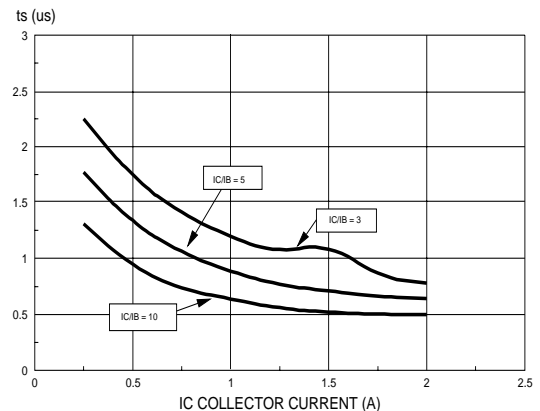
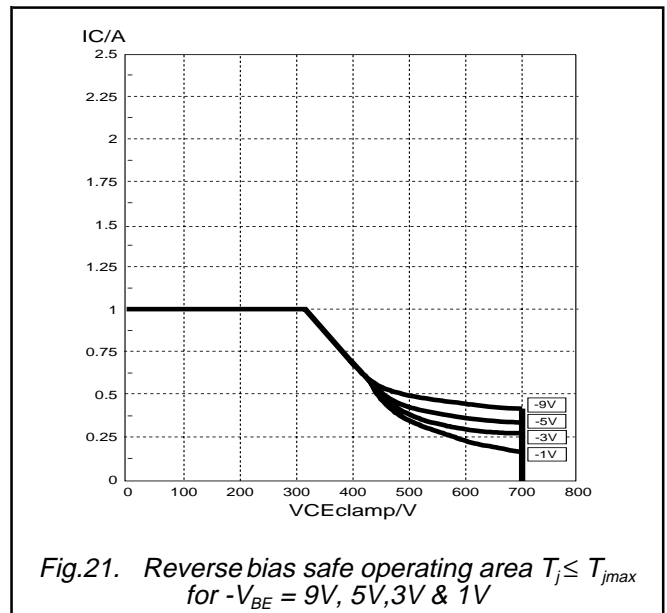
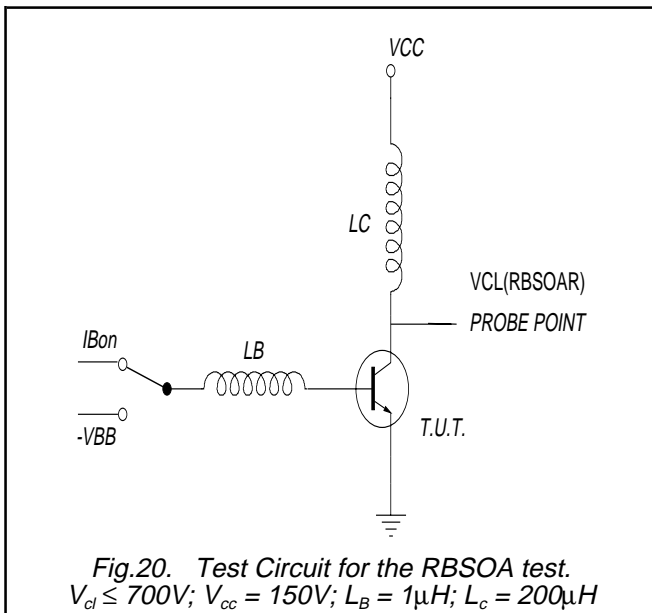
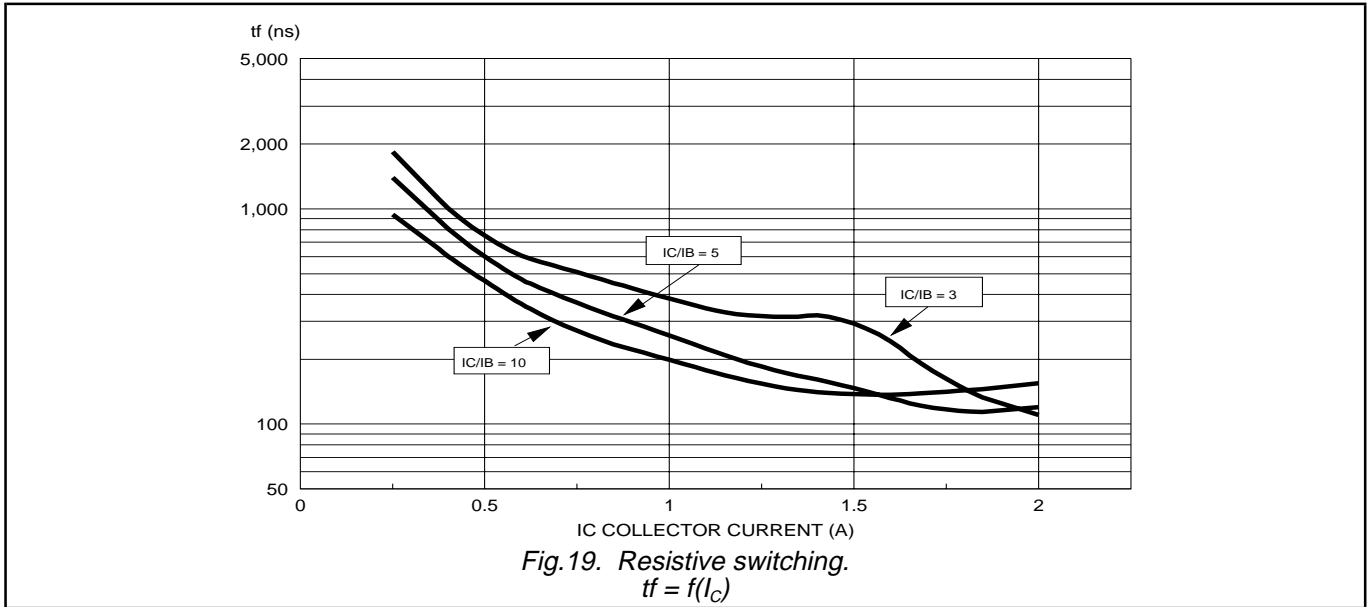

Fig.18. Resistive switching.
 $t_s = f(I_C)$

Silicon Diffused Power Transistor

BUJ100



Silicon Diffused Power Transistor

BUJ100

MECHANICAL DATA

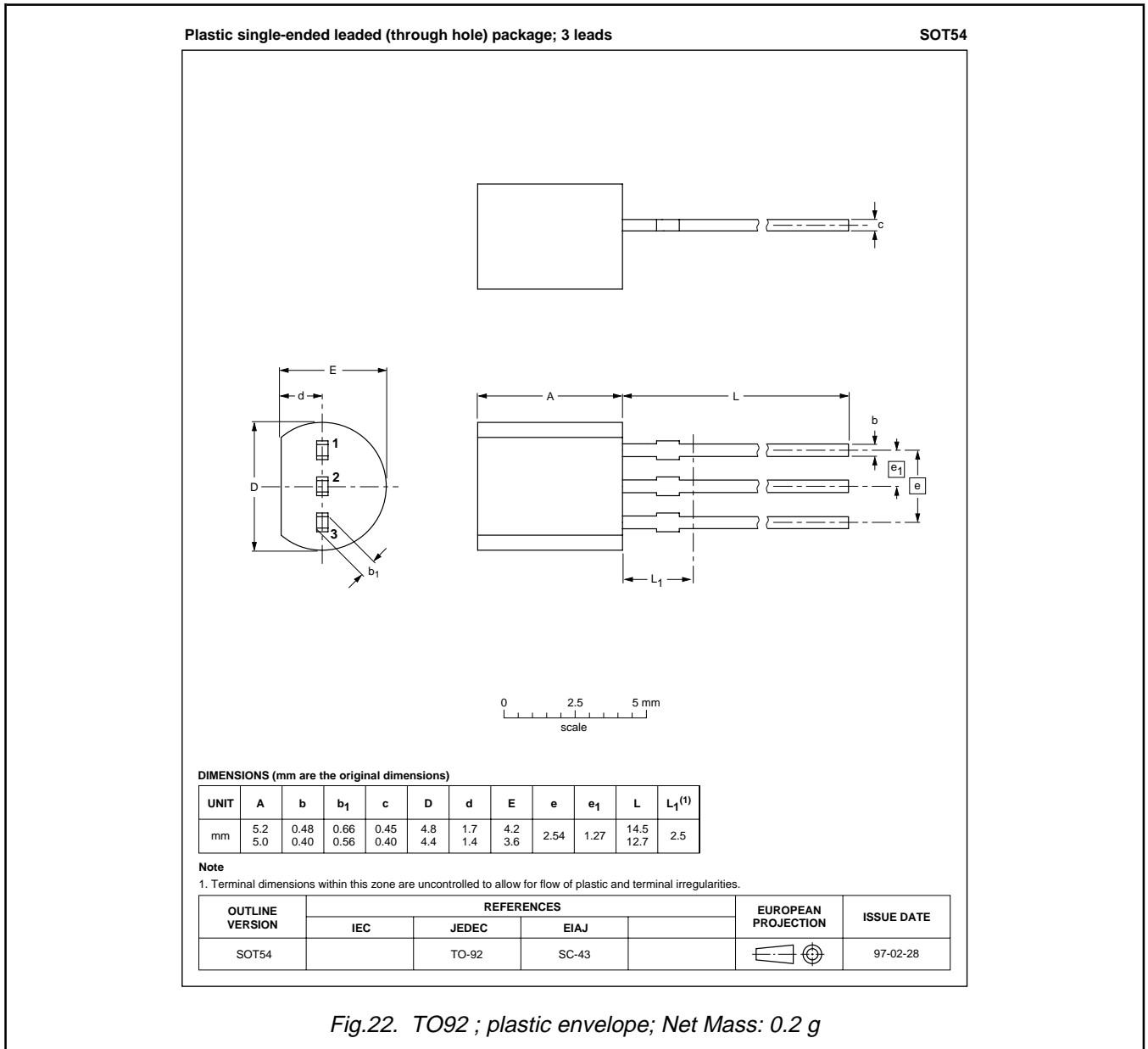

Notes

1. Epoxy meets UL94 V0 at 1/8".

Silicon Diffused Power Transistor

BUJ100

DEFINITIONS

Data sheet status	
Objective specification	This data sheet contains target or goal specifications for product development.
Preliminary specification	This data sheet contains preliminary data; supplementary data may be published later.
Product specification	This data sheet contains final product specifications.
Limiting values	
Limiting values are given in accordance with the Absolute Maximum Rating System (IEC 134). Stress above one or more of the limiting values may cause permanent damage to the device. These are stress ratings only and operation of the device at these or at any other conditions above those given in the Characteristics sections of this specification is not implied. Exposure to limiting values for extended periods may affect device reliability.	
Application information	
Where application information is given, it is advisory and does not form part of the specification.	
© Philips Electronics N.V. 1999	
All rights are reserved. Reproduction in whole or in part is prohibited without the prior written consent of the copyright owner.	
The information presented in this document does not form part of any quotation or contract, it is believed to be accurate and reliable and may be changed without notice. No liability will be accepted by the publisher for any consequence of its use. Publication thereof does not convey nor imply any license under patent or other industrial or intellectual property rights.	

LIFE SUPPORT APPLICATIONS

These products are not designed for use in life support appliances, devices or systems where malfunction of these products can be reasonably expected to result in personal injury. Philips customers using or selling these products for use in such applications do so at their own risk and agree to fully indemnify Philips for any damages resulting from such improper use or sale.