

MITSUBISHI Nch POWER MOSFET

FY5ACH-03A

HIGH-SPEED SWITCHING USE

FY5ACH-03A

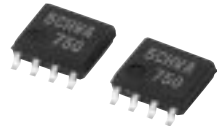

- 2.5V DRIVE
- V_{DSS} 30V
- r_{DS (ON)} (MAX) 50mΩ
- I_D 5A

OUTLINE DRAWING

Dimensions in mm

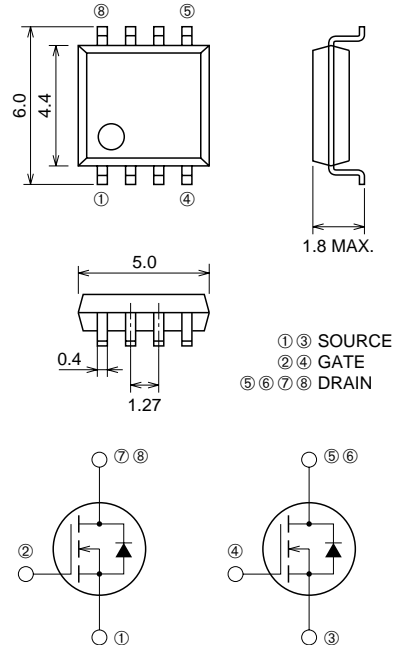

SOP-8

APPLICATION

Motor control, Lamp control, Solenoid control
DC-DC converter, etc.

MAXIMUM RATINGS (T_c = 25°C)

Symbol	Parameter	Conditions	Ratings	Unit
V _{DSS}	Drain-source voltage	V _{GS} = 0V	30	V
V _{GSS}	Gate-source voltage	V _{DS} = 0V	±10	V
I _D	Drain current		5	A
I _{DM}	Drain current (Pulsed)		35	A
I _{DA}	Avalanche drain current (Pulsed)	L = 10μH	5	A
I _S	Source current		1.7	A
I _{SM}	Source current (Pulsed)		6.8	A
P _D	Maximum power dissipation		1.6	W
T _{ch}	Channel temperature		-55 ~ +150	°C
T _{stg}	Storage temperature		-55 ~ +150	°C
—	Weight	Typical value	0.07	g

Sep.1998

ELECTRICAL CHARACTERISTICS (Tch = 25°C)

Symbol	Parameter	Test conditions	Limits			Unit
			Min.	Typ.	Max.	
V (BR) DSS	Drain-source breakdown voltage	Id = 1mA, Vds = 0V	30	—	—	V
IGSS	Gate-source leakage current	VGS = ±10V, VDS = 0V	—	—	±0.1	μA
IDSS	Drain-source leakage current	VDS = 30V, VGS = 0V	—	—	0.1	mA
VGS (th)	Gate-source threshold voltage	Id = 1mA, Vds = 10V	0.5	0.9	1.3	V
rDS (ON)	Drain-source on-state resistance	Id = 5A, VGS = 4V	—	40	50	mΩ
rDS (ON)	Drain-source on-state resistance	Id = 2.5A, VGS = 2.5V	—	52	80	mΩ
VDS (ON)	Drain-source on-state voltage	Id = 5A, VGS = 4V	—	0.20	0.25	V
yfs	Forward transfer admittance	Id = 5A, VDS = 10V	—	11	—	S
Ciss	Input capacitance	Vds = 10V, VGS = 0V, f = 1MHz	—	750	—	pF
Coss	Output capacitance		—	180	—	pF
Crss	Reverse transfer capacitance		—	80	—	pF
td (on)	Turn-on delay time	VDD = 15V, Id = 2.5A, VGS = 4V, RGEN = RGS = 50Ω	—	18	—	ns
tr	Rise time		—	45	—	ns
td (off)	Turn-off delay time		—	52	—	ns
tf	Fall time		—	44	—	ns
VSD	Source-drain voltage	Is = 1.7A, VGS = 0V	—	0.75	1.1	V
Rth (ch-a)	Thermal resistance	Channel to ambient	—	—	78.1	°C/W
trr	Reverse recovery time	Is = 1.7A, dis/dt = -50A/μs	—	100	—	ns

PERFORMANCE CURVES

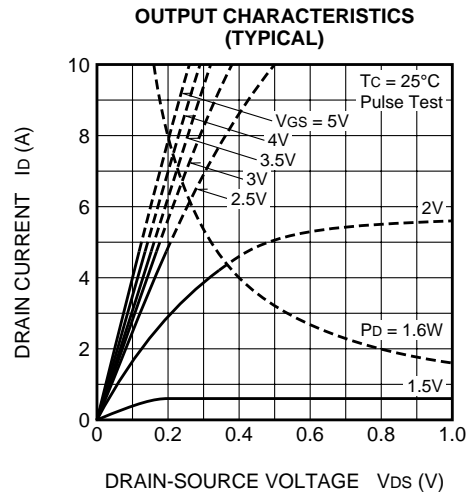
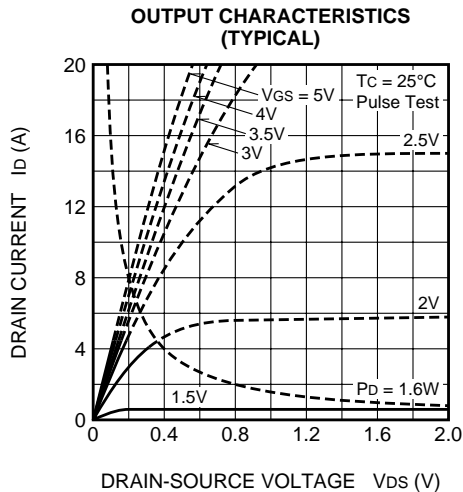
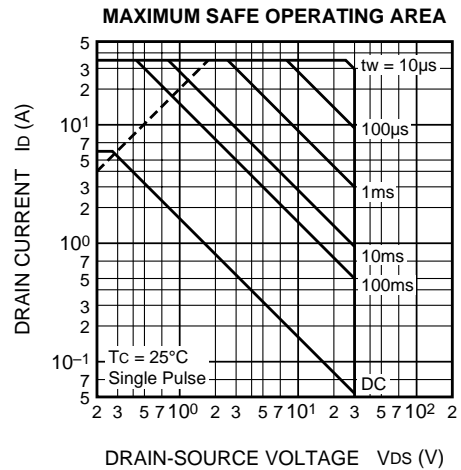
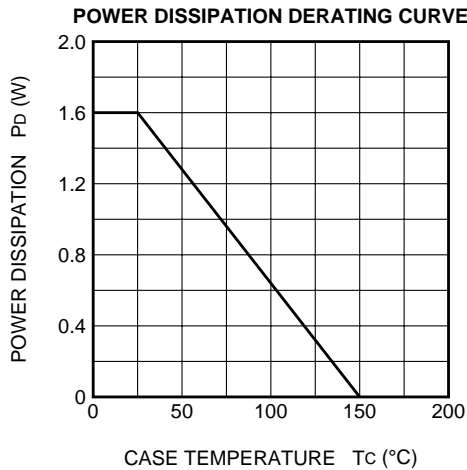

ON-STATE VOLTAGE VS. GATE-SOURCE VOLTAGE (TYPICAL)

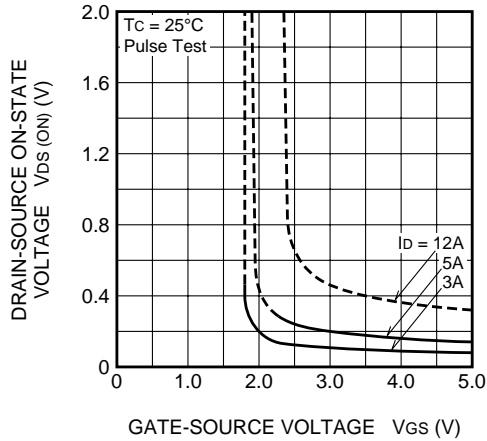

ON-STATE RESISTANCE VS. DRAIN CURRENT (TYPICAL)

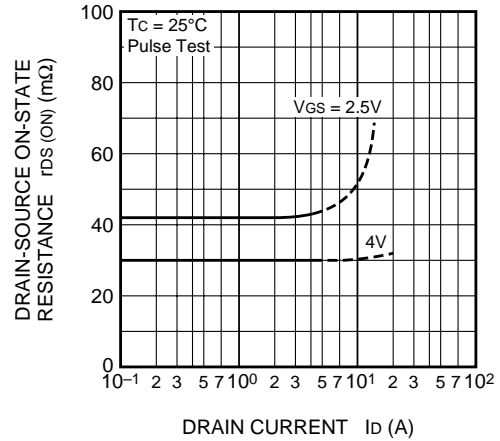

TRANSFER CHARACTERISTICS (TYPICAL)

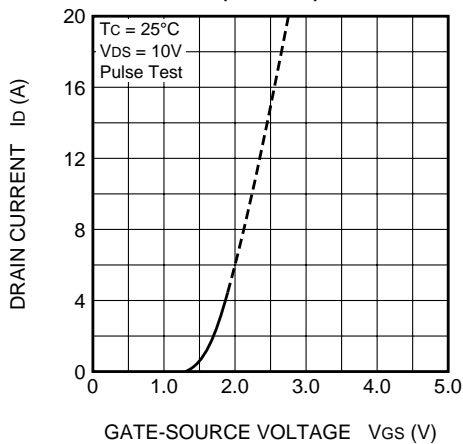

FORWARD TRANSFER ADMITTANCE VS. DRAIN CURRENT (TYPICAL)

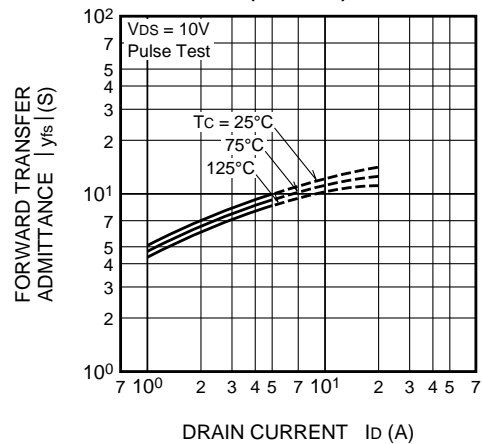

CAPACITANCE VS. DRAIN-SOURCE VOLTAGE (TYPICAL)

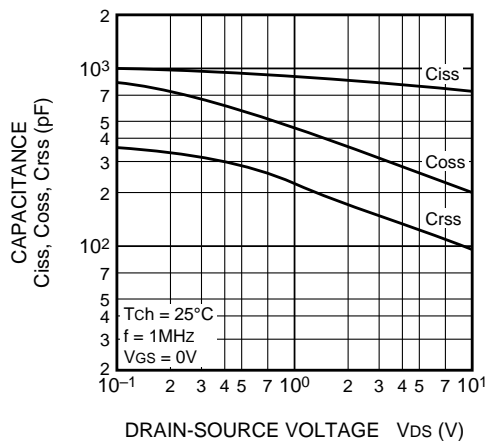

SWITCHING CHARACTERISTICS (TYPICAL)

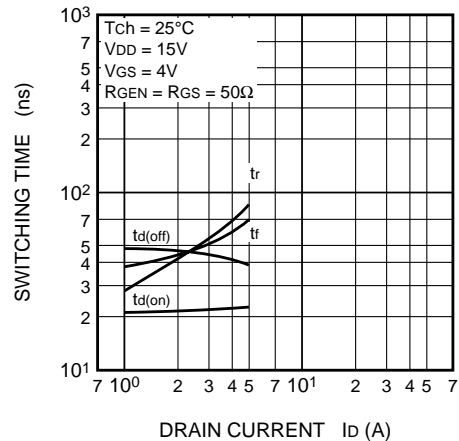

GATE-SOURCE VOLTAGE VS. GATE CHARGE (TYPICAL)

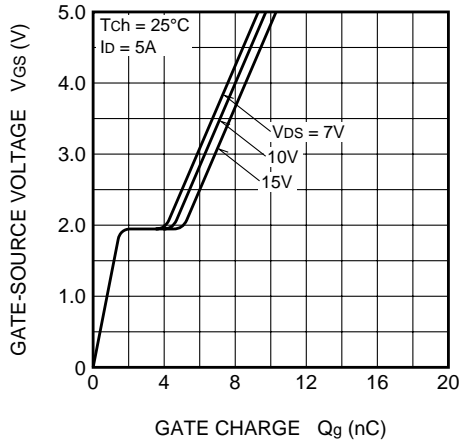

SOURCE-DRAIN DIODE FORWARD CHARACTERISTICS (TYPICAL)

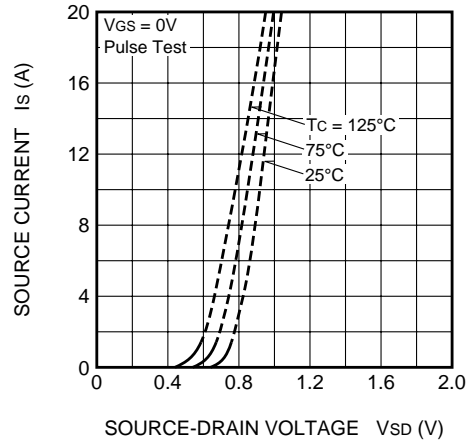

ON-STATE RESISTANCE VS. CHANNEL TEMPERATURE (TYPICAL)

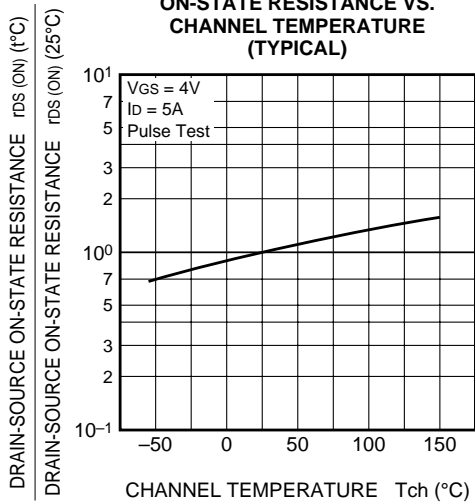

THRESHOLD VOLTAGE VS. CHANNEL TEMPERATURE (TYPICAL)

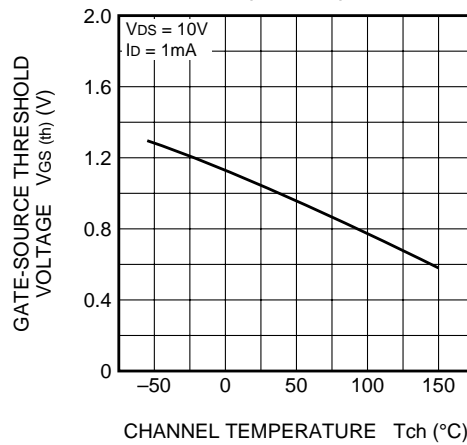

BREAKDOWN VOLTAGE VS. CHANNEL TEMPERATURE (TYPICAL)

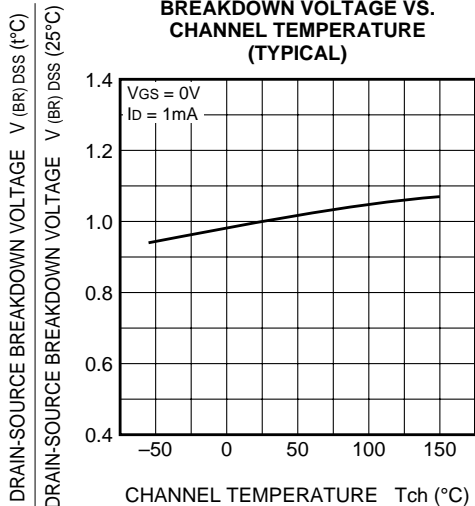

TRANSIENT THERMAL IMPEDANCE CHARACTERISTICS

