

General Description

The AAT3670 BatteryManager is a highly integrated single-cell lithium-ion/polymer (Li-ion) battery charger and system power management IC that enables simultaneous battery charging and full system usage without compromising the battery's charge cycle life. It operates with low-voltage AC adapter (ADP) and USB inputs and requires a minimum number of external components.

The AAT3670 selects ADP or USB to power the system load and charge the battery when ADP/USB power is available. The AAT3670 precisely regulates battery charge voltage and current for 4.2V Li-ion cells. Charge current can be programmed up to 1.6A for ADP charging and 0.9A or 0.1A for USB charging by resistors on the ADPSET/ USBSET pins. The charge termination current threshold is set by an external resistor on the TERM pin.

The AAT3670 has a voltage-sensed charge current reduction loop that enables system operation without a power shortage. When the input voltage falls below the programmable charge reduction threshold, the device automatically reduces the charge current until the input voltage returns to the threshold voltage.

Battery temperature and charge state are fully monitored for fault conditions. In the event of a battery over-voltage/short-circuit/over-temperature condition, the charger will automatically shut down, protecting the charging device, control system, and battery. Two status monitor output pins (STAT1 and STAT2) are provided to indicate battery charge status by directly driving external LEDs.

The AAT3670 is available in a Pb-free, thermally-enhanced, space-saving 24-pin 4x4mm QFN package.

Features

- ADP, USB, or Battery Powers System Load Through Internal Current-Limited Switches
- Simultaneous Battery Charging and System Usage
- Voltage Sensed Charge Reduction Loop to Minimize Charge Time, Even While the System Operates
- Digitized Thermal Loop
- Battery Power Enable (ENBAT)
- Battery Charge Timer (CT)
- Battery Temperature Monitoring (TS)
- Battery Charge Status Report (/STATx)
- Automatic Recharge Sequencing
- Battery Under-Voltage, Over-Voltage, and Over-Current Protection
- System Load Current Limiting
- Thermal Protection
- 24-pin 4x4mm QFN Package

Applications

- Cellular Telephones
- Digital Still Cameras
- Personal Data Assistants (PDAs)
- Hand Held PCs
- MP3 Players and PMP
- Other Li-ion Battery Powered Devices

Typical Application

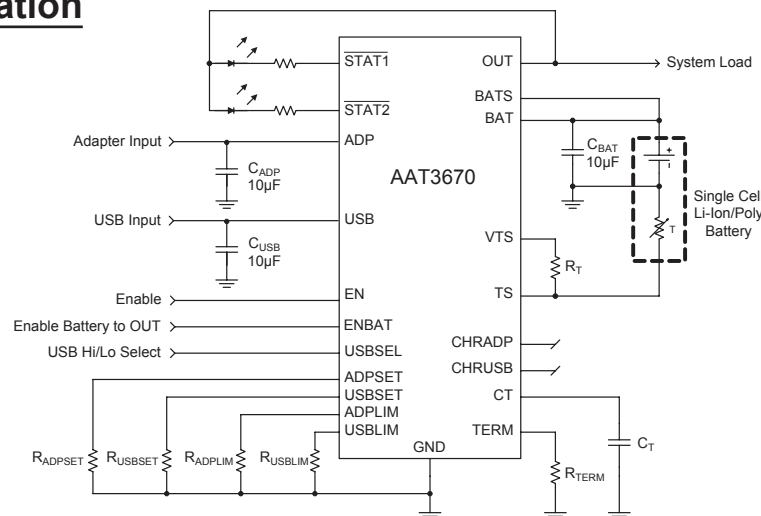

Pin Descriptions

Pin #	Name	Type	Function
1	USBSEL	I	Logic input. High for 100% USB charge current set by USBSET; low for 20% (constant current charge mode) or 50% (trickle charge mode) charge current set by the USBSET resistor.
2, 3	OUT	O	System load output; a capacitor with a minimum value of 10 μ F (including all capacitance on the load of OUT) is required.
4, 5	BAT	I/O	Battery pack input/output. For best operation, a 1 μ F ceramic capacitor should be placed between BAT and GND.
6	ADP	I	AC adapter input, source of system load and battery charging. Minimum 1 μ F input capacitor.
7	VTS	O	Voltage reference for battery temperature sensing.
8	TS	I	Battery temperature sensing input. Use an NTC resistor from TS pin to ground and a 1% standard resistor that has equal resistance of the NTC at 25°C from VTS to TS for battery temperature sensing. Tie TS pin to ground to disable the temperature sensing function.
9	BATS	I	Battery sense pin.
10	CHRADP	I/O	ADP voltage sensed charge reduction programmable pin. A resistor divider from ADP to this pin and GND sets the charge reduction threshold. When this pin is open, the charge reduction threshold is 4.6V. If this pin is tied to the ADP pin, the charge reduction is disabled.
11	ADPLIM	I	Connect a resistor to this pin to set the ADP input current limit (including load switch and charger currents).
12	USBLIM	I	Connect a resistor to this pin to set the USB input current limit (including load switch and charger currents).
13	ADPSET	I	Connect a resistor to this pin to set the ADP charge current (for trickle charge and constant current charge). The CC current set by this pin should be less than the current limit set by ADPLIM, otherwise the CC current will be limited by ADPLIM.
14	USBSET	I	Connect a resistor to this pin to set the USB charge current (for trickle charge and constant current charge). The CC current set by this pin should be less than the current limit set by USBLIM, otherwise the CC current will be limited by USBLIM.
15	GND	I/O	Common ground.
16	TERM	I	Connect a resistor to this pin to program the charge termination current threshold. No termination current setting when this pin is pulled up to a logic high level.
17	EN	I	ADP/USB enable input. High or floating (internal pull-up) to enable ADP/USB switch and ADP/USB battery charging; low to disable ADP/USB switch and ADP/USB battery charging.

Pin Descriptions (continued)

Pin #	Name	Type	Function
18	CT	I	Battery charge timer input pin. Connect a capacitor to this pin to set the ADP charge timers. No time-out for USB charging. Timers are disabled when this pin is grounded. The timer is suspended if the battery temperature is not within 0 to 50°C or is in charge reduction (either due to the supply voltage dropping or the device temperature rising) is activated. The timer continues where it left off after the battery temperature returns to normal and the device is out of the charge reduction loops.
19	STAT2	O	Open drain charger status reporting.
20	STAT1	O	Open drain charger status reporting.
21	N/C		No connection.
22	USB	I	USB input, source of system load and battery charging when ADP is not available. Minimum 1µF input capacitor.
23	CHRUSB	I/O	USB voltage sensed charge reduction programmable pin. A resistor divider from USB to this pin and GND sets the charge reduction threshold. When this pin is open, the charge reduction threshold is 4.5V. If this pin is tied to the USB pin, charge reduction is disabled.
24	ENBAT	I	Battery load switch enable, active high.
EP			Exposed paddle (bottom). Connect to ground as closely as possible to the device.

Pin Configuration

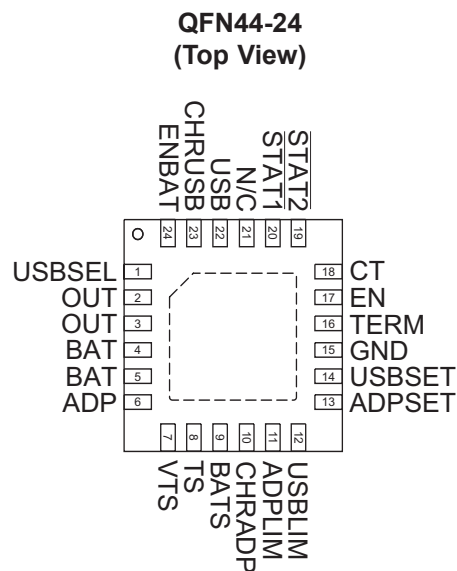

Absolute Maximum Ratings¹

Symbol	Description	Value	Units
V_P	ADP, USB, BAT, OUT, BATS <30ms, Duty Cycle < 10%	-0.3 to 7.0	V
V_P	ADP, USB BAT, OUT, BATS Continuous	-0.3 to 6	V
	USBSEL, EN, ENBAT, STAT1, STAT2	-0.3 to 6	V
V_N	VTS, TS, CT, ADPLIM, USBLIM, ADPSET, USBSET, TERM, CHRADP, CHRUSB	-0.3 to $V_P + 0.3$	V
T_J	Operating Junction Temperature Range	-40 to 150	°C
T_{LEAD}	Maximum Soldering Temperature (at Leads)	300	°C

Thermal Information²

Symbol	Description	Value	Units
θ_{JA}	Maximum Thermal Resistance	50	°C/W
P_D	Maximum Power Dissipation	2.0	W

1. Stresses above those listed in Absolute Maximum Ratings may cause permanent damage to the device. Functional operation at conditions other than the operating conditions specified is not implied. Only one Absolute Maximum Rating should be applied at any one time.
2. Mounted on a FR4 board.

Electrical Characteristics

$V_{ADP} = 5V$, $T_A = -25^\circ C$ to $+85^\circ C$; unless otherwise noted, typical values are $T_A = 25^\circ C$.

Symbol	Description	Conditions	Min	Typ	Max	Units
Operation						
V_{ADP}	AC Adapter Operating Voltage Range		4.35		5.5	V
V_{USB}	USB Operating Voltage Range		4.35		5.5	V
V_{BAT}	Battery Operating Voltage Range		3.0		V_{BAT_EOC}	V
V_{UVLO_ADP}	ADP Under-Voltage Lockout	Rising Edge		3.6		V
		Hysteresis		0.3		
V_{UVLO_USB}	USB Under-Voltage Lockout	Rising Edge		3.6		V
		Hysteresis		0.3		
V_{UVLO_BAT}	BAT Under-Voltage Lockout	Rising Edge	2.8	2.9	3.0	V
		Hysteresis		0.1		
I_{ADP_OP}	ADP Normal Operating Current	$V_{ADP} = V_{EN} = 5V$, $I_{CC} = 1A$		0.5	1	mA
I_{ADP_SHDN}	ADP Shutdown Mode Current	$V_{ADP} = 5V$, $V_{EN} = 0V$, $V_{ENBAT} = 0V$, No Load			1	μA
I_{USB_OP}	USB Normal Operating Current	$V_{USB} = V_{EN} = 5V$, $I_{CC} = 0.5A$		0.5	1	mA
I_{USB_SHDN}	USB Shutdown Mode Current	$V_{USB} = 5V$, $V_{EN} = 0V$, $V_{ENBAT} = 0V$, No Load			1	μA
I_{BAT_OP}	Battery Operating Current	$V_{BAT} = V_{BAT_EOC}$, $V_{ADP} = GND$, $V_{USB} = GND$, $V_{ENBAT} = 5V$, No Load		45	80	μA
I_{BAT_SLP}	Battery Sleep Current	$V_{BAT} = V_{BAT_EOC}$, $V_{ADP} = 5V$ or $V_{USB} = 5V$, $V_{EN} = V_{ENBAT} = 5V$		2	5	μA
I_{BAT_SHDN}	Leakage Current from BAT Pin	$V_{BAT} = V_{BAT_EOC}$, $V_{ENBAT} = 0V$			1	μA
Power Switches						
$R_{DS(ON)_SWA}$	ADP-to-OUT FET On Resistance	$V_{ADP} = 5.0V$		0.4		Ω
$R_{DS(ON)_SWU}$	USB-to-OUT FET On Resistance	$V_{USB} = 5.0V$		0.7		Ω
$R_{DS(ON)_SWB}$	BAT-to-OUT FET On Resistance	$V_{BAT} = 4.2V$		0.1		Ω
$R_{DS(ON)_CHA}$	ADP Battery Charging FET On Resistance	$V_{ADP} = 5.0V$		0.4		Ω
$R_{DS(ON)_CHU}$	USB Battery Charging FET On Resistance	$V_{USB} = 5.0V$		0.7		Ω

Electrical Characteristics (continued)

$V_{ADP} = 5V$, $T_A = -25^{\circ}C$ to $+85^{\circ}C$; unless otherwise noted, typical values are $T_A = 25^{\circ}C$.

Symbol	Description	Conditions	Min	Typ	Max	Units
Battery Charge Voltage Regulation						
V_{BAT_EOC}	Output Charge Voltage Regulation ¹	For 4.2V Cells	4.158	4.20	4.242	V
V_{MIN}	Preconditioning Voltage Threshold		2.8	2.9	3.0	V
V_{RCH}	Battery Recharge Voltage Threshold		$V_{BAT_EOC} - 0.17$	$V_{BAT_EOC} - 0.1$	$V_{BAT_EOC} - 0.05$	V
V_{CHR_TH}	Default ADP Charge Reduction Threshold	CHRADP Open; Reduce Charge Current When ADP is Below V_{CHR_TH}		4.6		V
	Default USB Charge Reduction Threshold	CHRUSB Open; Reduce Charge Current When USB is Below V_{CHR_TH}		4.5		
V_{CHR_REG}	CHRADP and CHRUSB Pin Voltage Accuracy		1.9	2.0	2.1	V
Current Regulation						
I_{LIM_ADP}	Maximum ADP Current Limit		1.6			A
I_{LIM_USB}	Maximum USB Current Limit		0.9			A
I_{LIM_BAT}	BAT_OUT Current Limit (Fixed)		2.3			A
$I_{CH_CC_ADP}$	ADP Charge Constant Current Charge Range		100		1600	mA
$I_{CH_CC_USB_H}$	USB High-Power Charge Constant Current Charge Range	USBSEL = 5V	50		900	mA
$I_{CH_CC_USB_L}$	USB Low-Power Charge Constant Current Charge Range	USBSEL = 0V	10		180	mA
$\Delta I_{CH_CC}/I_{CH_CC}$	Constant Current Charge Current Regulation Tolerance	$I_{CH_CC_ADP} = 1A$ $I_{CH_CC_USB_H} = 0.5A$ $I_{CH_CC_USB_L} = 0.1A$	-12		12	%
$I_{CH_TKL_ADP}$	ADP Charge Trickle Charge			10		% $I_{CH_CC_ADP}$
$I_{CH_TKL_USB_H}$	USB High-Power Charge Trickle Charge	USBSEL = 5V		10		% $I_{CH_CC_USBH}$
$I_{CH_TKL_USB_L}$	USB Low-Power Charge Trickle Charge	USBSEL = 0V		50		% $I_{CH_CC_USBL}$

1. The output charge voltage accuracy is specified over the 0° to $70^{\circ}C$ ambient temperature range; operation over the $-25^{\circ}C$ to $+85^{\circ}C$ temperature range is guaranteed by design.

Electrical Characteristics (continued)

$V_{ADP} = 5V$, $T_A = -25^\circ C$ to $+85^\circ C$; unless otherwise noted, typical values are $T_A = 25^\circ C$.

Symbol	Description	Conditions	Min	Typ	Max	Units
Current Regulation (continued)						
V_{ADPLIM}	ADPLIM Pin Voltage Regulation			2		V
V_{USBLIM}	USBLIM Pin Voltage Regulation			2		V
V_{ADPSET}	ADPSET Pin Voltage Regulation			2		V
V_{USBSET}	USBSET Pin Voltage Regulation			2		V
V_{TERM}	TERM Pin Voltage Regulation			2		V
$K_{I_CC_ADP}$	Constant Current Charge Current Set Factor: I_{CH_ADP}/I_{ADPSET}			29300		
$K_{I_CC_USBH}$	Constant Current Charge Current Set Factor: I_{CH_USB}/I_{USBSET}	USBSEL = 5V		17900		
$K_{I_CC_USBL}$	Constant Current Charge Current Set Factor: I_{CH_USB}/I_{USBSET}	USBSEL=0V		3600		
$K_{I_LIM_ADP}$	Current Limit Set Factor: I_{LIM_ADP}/I_{ADPLIM}			27800		
$K_{I_LIM_USBH}$	Current Limit Set Factor: I_{LIM_USB}/I_{USBLIM}	USBSEL = 5V		17600		
$K_{I_LIM_USBL}$	Current Limit Set Factor: I_{LIM_USB}/I_{USBLIM}	USBSEL = 0V		3500		
K_{I_TERM}	Termination Current Set Factor: I_{CH_TERM}/I_{TERM}			2000		
Logic Control/Protection						
V_{EN}	Input High Threshold		1.6			V
V_{EN}	Input Low Threshold				0.4	V
V_{STATx}	Output Low Voltage	/STATx Pin Sinks 8mA			0.4	V
T_C	Fast Charge (Constant Current and Constant Voltage Charges Together) Timeout	$C_{CT} =$ 100nF	ADP	6		hour
			USB	infinite		
T_{TKL}	Trickle Charge Timeout		ADP	$T_C/8$		
			USB	infinite		
V_{OVP}	Battery Over-Voltage Protection Threshold		$V_{BAT_EOC} + 0.1$	$V_{BAT_EOC} + 0.15$	$V_{BAT_EOC} + 0.2$	V
I_{OCP}	Battery Charge Over-Current Protection Threshold	In All Modes		100		$\%I_{CH_CC}$
I_{VTS}	VTS Sourcing Capability	$V_{VTS} = 2.5V$	1			mA

Electrical Characteristics (continued)

$V_{ADP} = 5V$, $T_A = -25^{\circ}C$ to $+85^{\circ}C$; unless otherwise noted, typical values are $T_A = 25^{\circ}C$.

Symbol	Description	Conditions	Min	Typ	Max	Units
Logic Control/Protection (continued)						
TS1	TS Hot Temperature Fault	Threshold	28	30	32	%V _{TS}
		Hysteresis		2		
TS2	TS Cold Temperature Fault	Threshold	70	72	74	%V _{TS}
		Hysteresis		2		
T _{LOOP_IN}	Digital Thermal Loop Entry Threshold	For ADP Charging		115		°C
T _{LOOP_OUT}	Digital Thermal Loop Exit Threshold	For ADP Charging		95		°C
T _{LOOP_REG}	Digital Thermal Loop Regulated Temperature	For ADP Charging		100		°C
T _{SHDN}	Chip Thermal Shutdown Temperature	Threshold		140		°C
		Hysteresis		15		

Typical Characteristics

Constant Current vs. Set Resistor
($V_{IN} = 5V$; $V_{BAT} = 3.5V$)

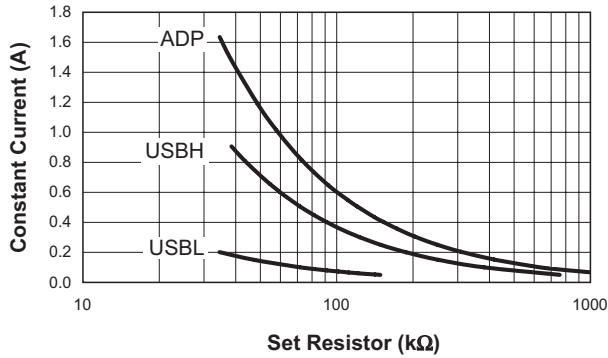

Adapter Mode Supply Current vs. ADPSET Resistor
($V_{IN} = 5V$; $V_{BAT} = 3.5V$)

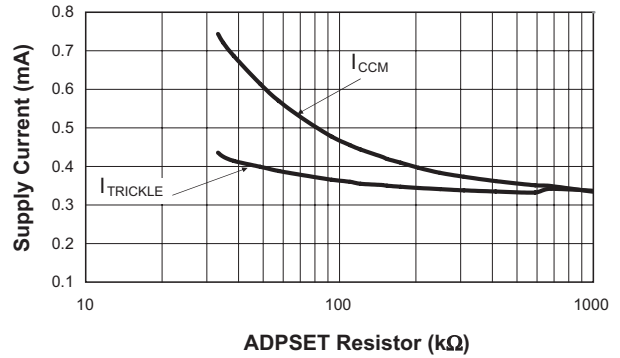

USB Mode Supply Current vs. USBSET Resistor
(USBL; $V_{IN} = 5V$; $V_{BAT} = 3.5V$)

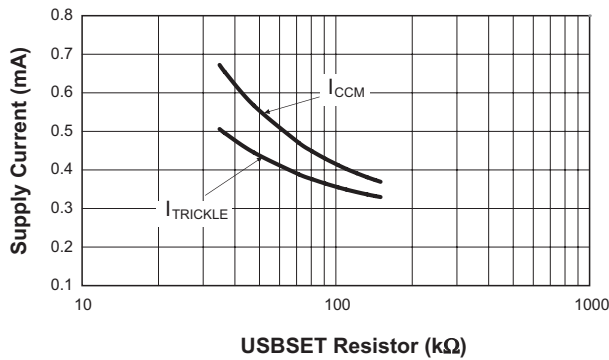

USB Mode Supply Current vs. USBSET Resistor
(USBH; $V_{IN} = 5V$; $V_{BAT} = 3.5V$)

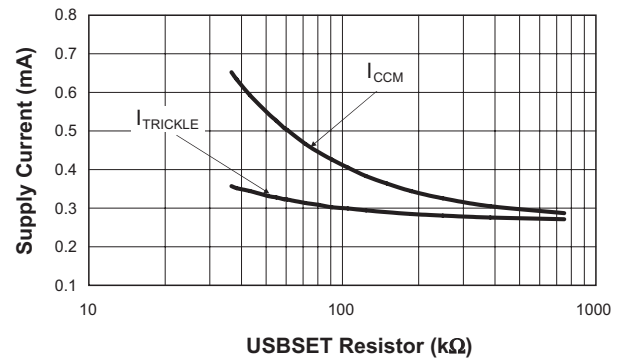

End of Charge Voltage vs. Supply Voltage

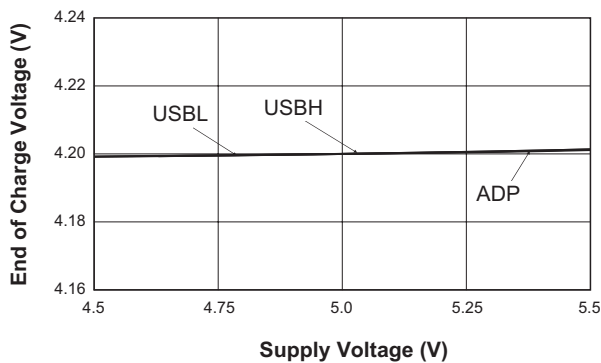

End of Charge Voltage vs. Temperature

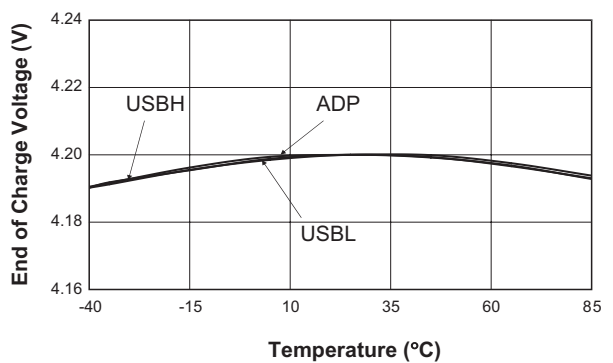

Typical Characteristics

Recharge Threshold Voltage vs. Temperature
($V_{IN} = 5.0V$)

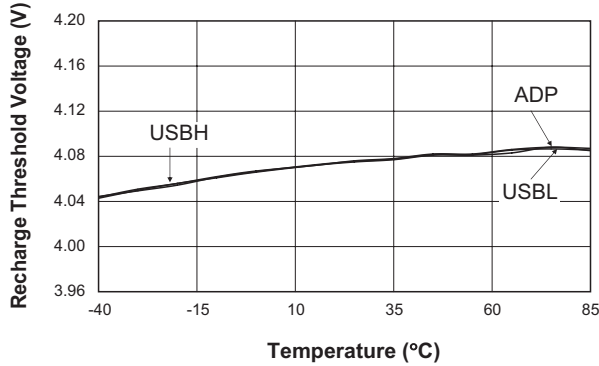

Preconditioning Threshold Voltage vs. Temperature
($V_{IN} = 5.0V$)

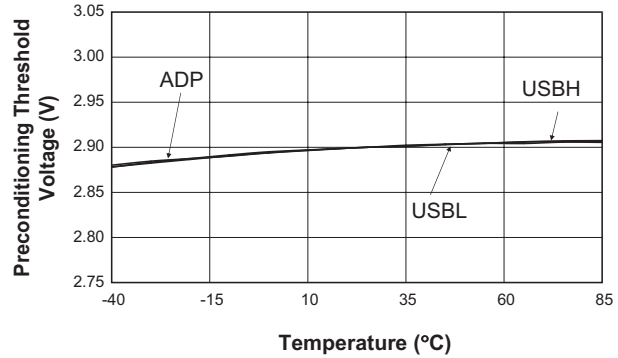

BAT to OUT Switch Voltage vs. Load Current
($V_{BAT} = 3.95V$)

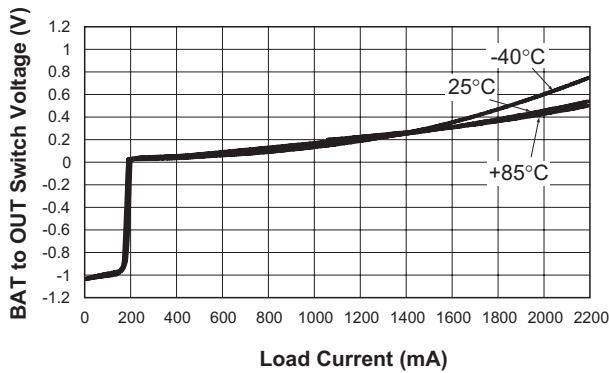

Preconditioning Charging Current vs. Temperature
($V_{IN} = 5.0V$)

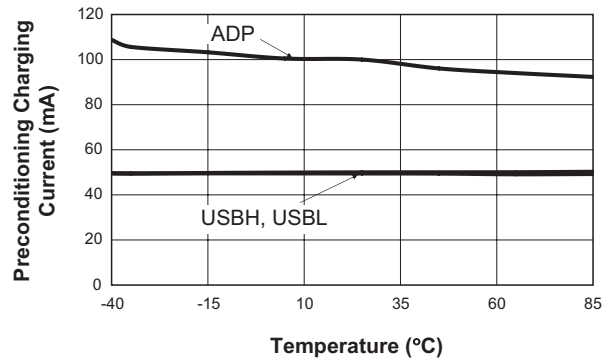

Charging Current vs. Battery Voltage
(ADP; ADPSET = 57.6K Ω)

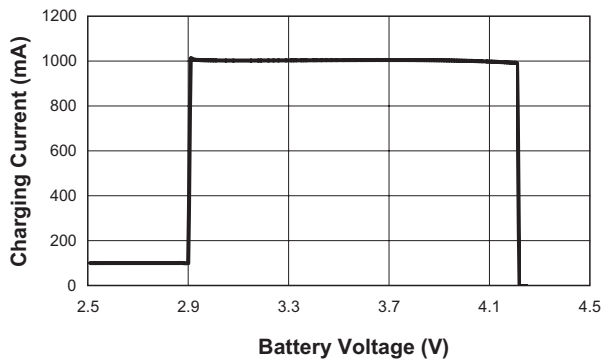

Charging Current vs. Battery Voltage
(USBH; USBSET = 71.5K Ω)

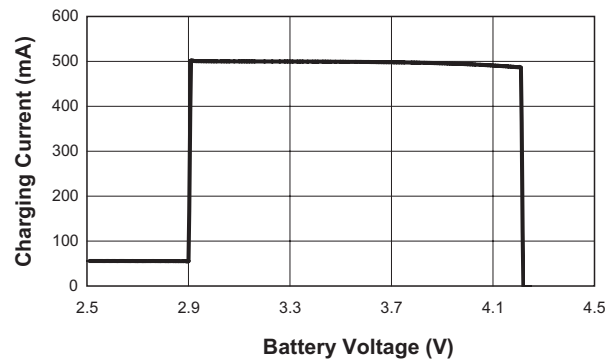

Typical Characteristics

Charging Current vs. Battery Voltage
(USBL; USBSET = 71.5kΩ)

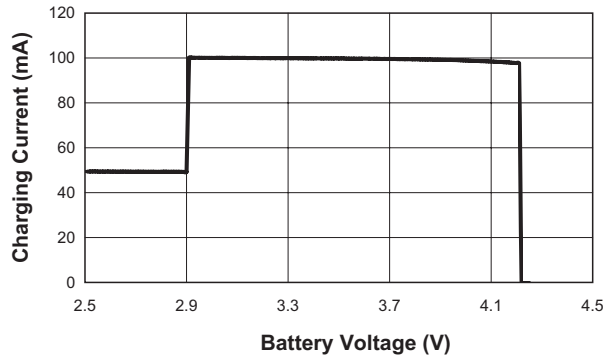

Constant Charge Current vs. Temperature
($V_{IN} = 5.0V$)

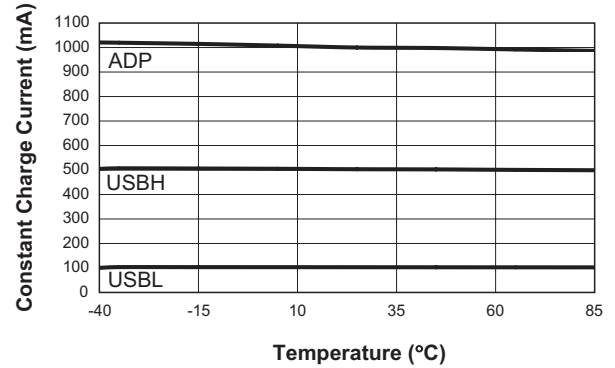

Constant Charging Current vs. Supply Voltage
(ADP; CHRADP = Open; ADPSET = 57.6kΩ)

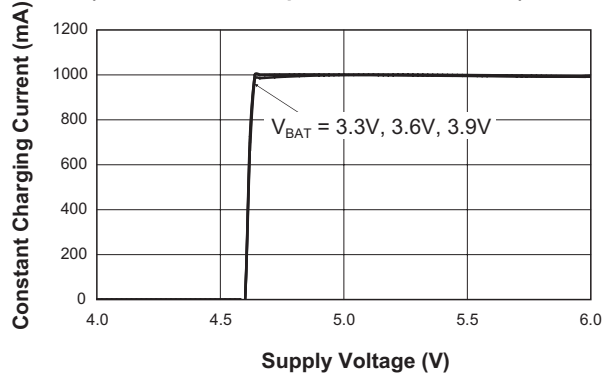

Constant Charging Current vs. Supply Voltage
(ADP; CHRADP = USB; ADPSET = 57.6kΩ)

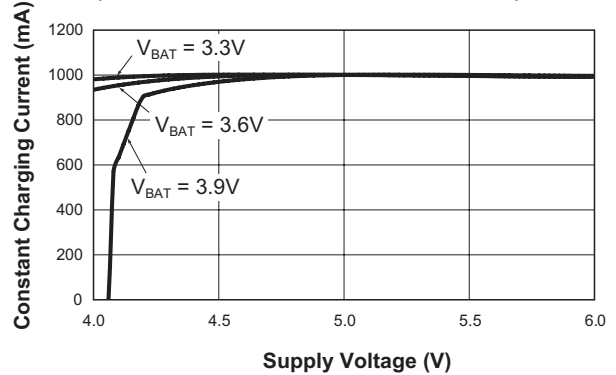

Constant Charging Current vs. Supply Voltage
(USBL; CHRUSB = Open; USBSET = 71.5kΩ)

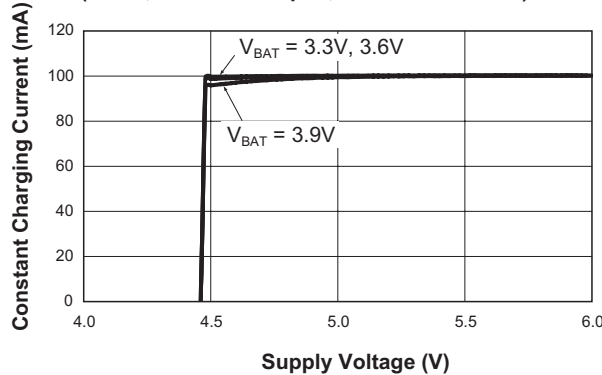

Constant Charging Current vs. Supply Voltage
(USBL; CHRUSB = USB; USBSET = 71.5kΩ)

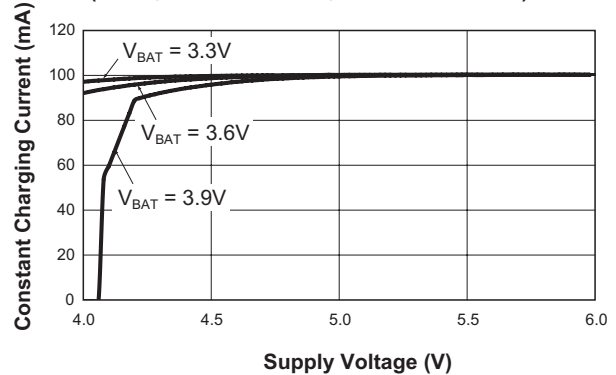

Typical Characteristics

Constant Charging Current vs. Supply Voltage
(USBH; CHRUSB = Open; USBSET = 71.5k Ω)

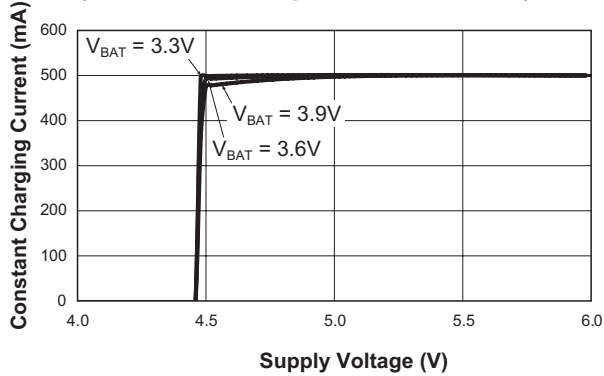

Constant Charging Current vs. Supply Voltage
(USBH; CHRUSB = USB; USBSET = 71.5k Ω)

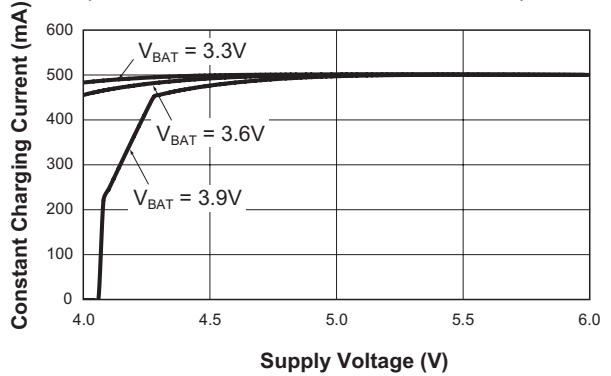

Constant Charging Current vs. Supply Voltage

(ADP; CHRADP = Open; $V_{BAT} = 3.6V$; ADPSET = 57.6k Ω)

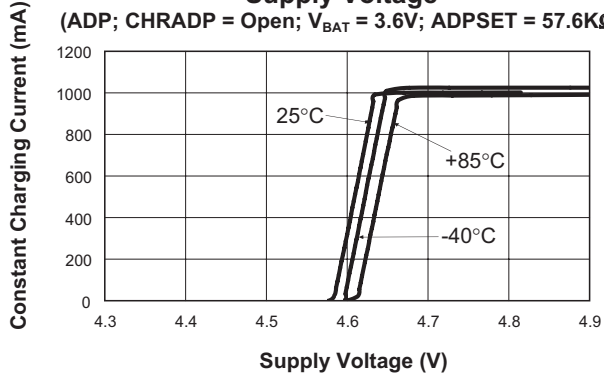

Constant Charging Current vs. Supply Voltage

(USBL; CHRUSB = Open; $V_{BAT} = 3.6V$; USBSET = 71.5k Ω)

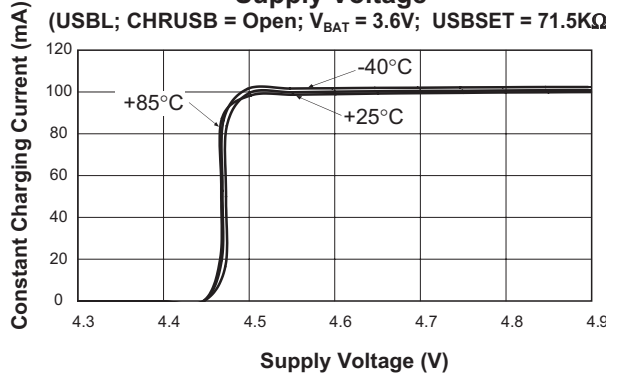

Constant Charging Current vs. Supply Voltage

(USBH; CHRUSB = Open; $V_{BAT} = 3.6V$; USBSET = 71.5k Ω)

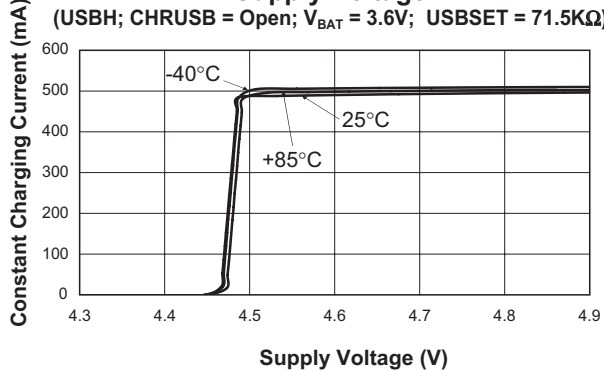

Typical Characteristics

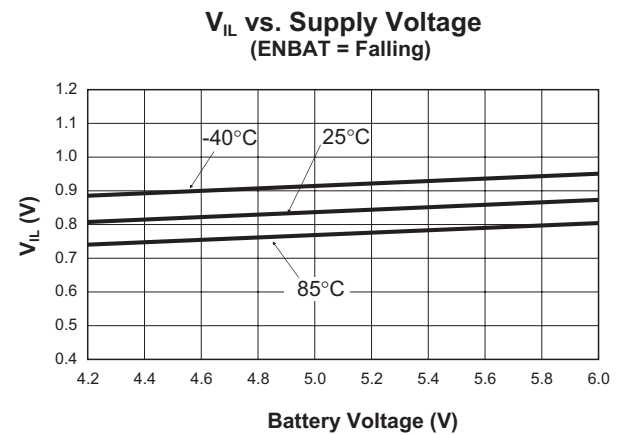
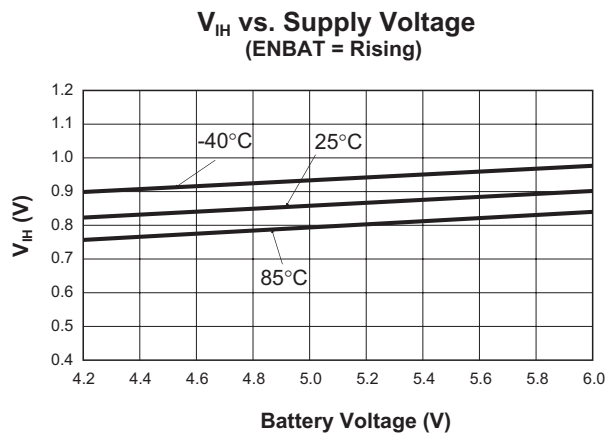
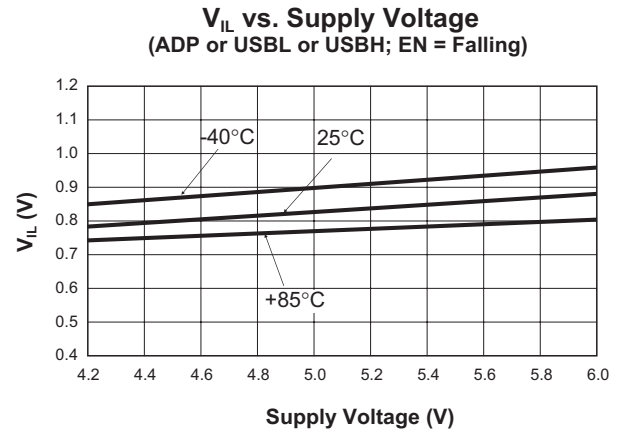
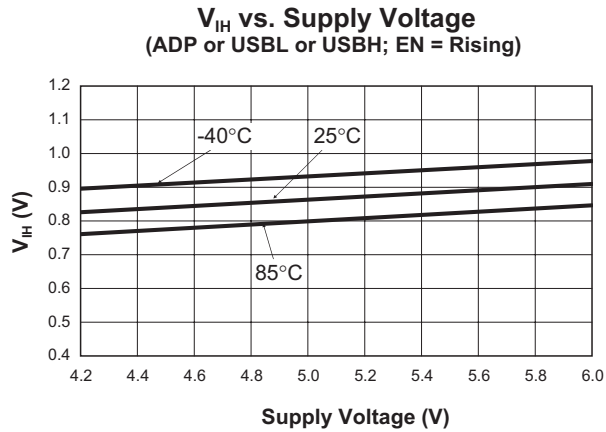

Adapter and Charging Current vs. Output Current
($V_{BAT} = 3.6V$)

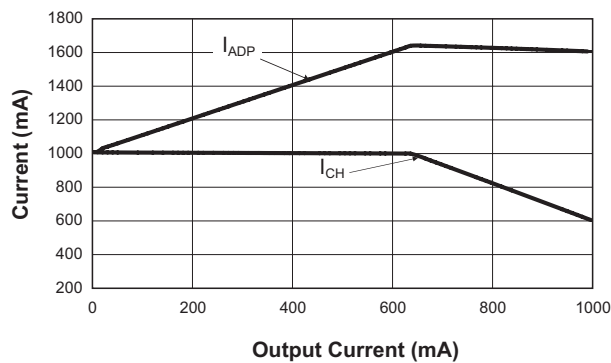

USB and Charging Current vs. Output Current
(USBL; $V_{BAT} = 3.6V$)

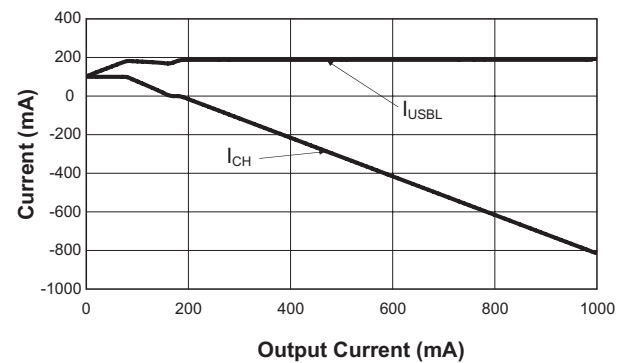

Typical Characteristics

USB and Charging Current vs. Output Current
(USBH; $V_{BAT} = 3.6V$)

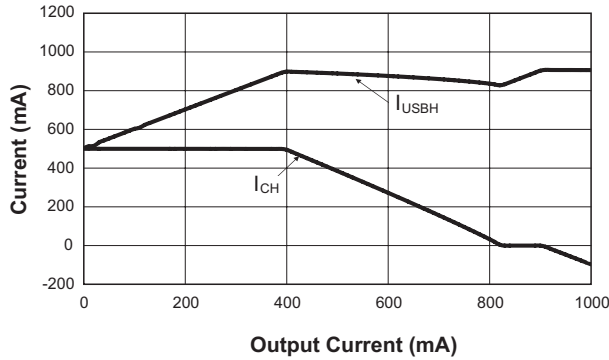

ADP Charge Current vs. Time

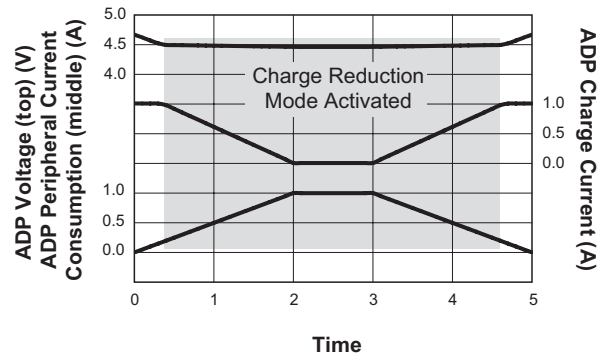

USB Charge Current vs. Time
(USBH)

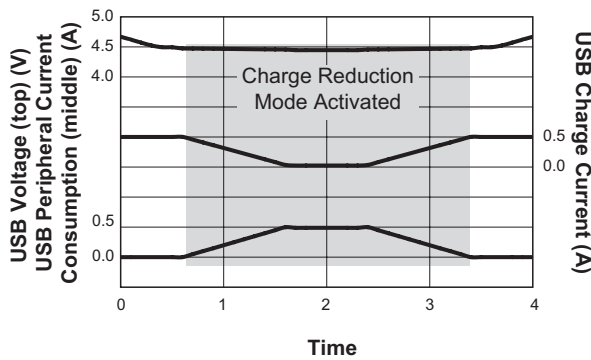

CT Current vs. Temperature
($C_T = 0.1F$)

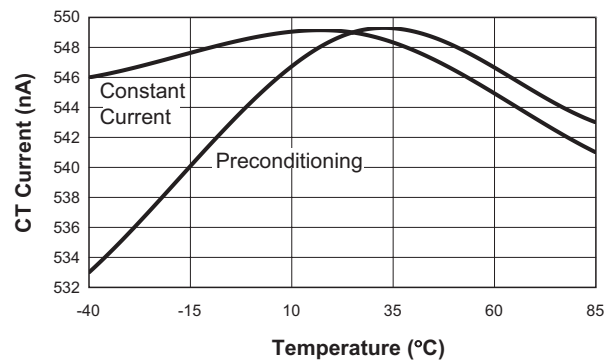

CT Timeout vs. Temperature
($C_T = 0.1F$)

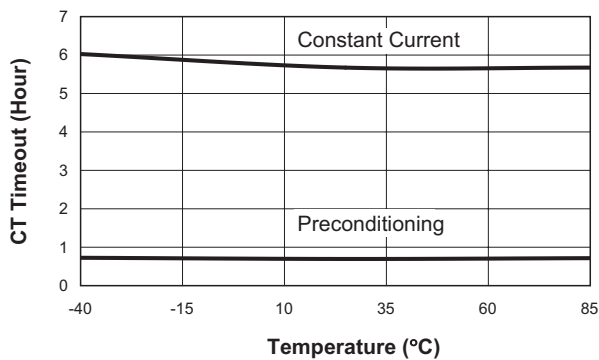

CT Pin Capacitance vs. Counter Timeout

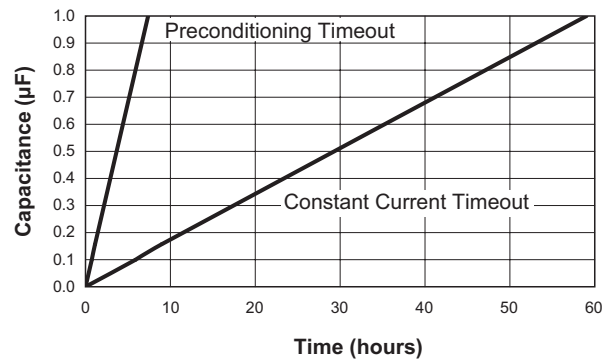

Typical Characteristics

Percentage of V_{VTS} vs. Temperature
(ADP or USBH or USBL; $V_{IN} = 5V$)

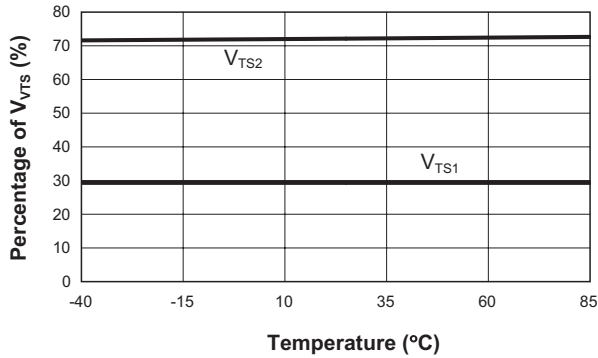

Total Input Current vs. Output Current
($V_{BAT} = 3.6V$)

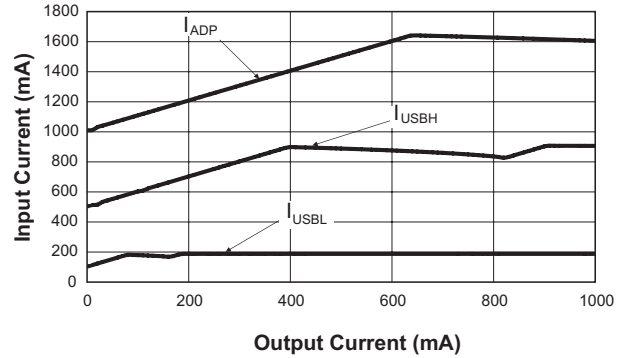

Transient Response of OUT
When Switching from ADP to BAT
($V_{ADP} = 5V \rightarrow 0V$)

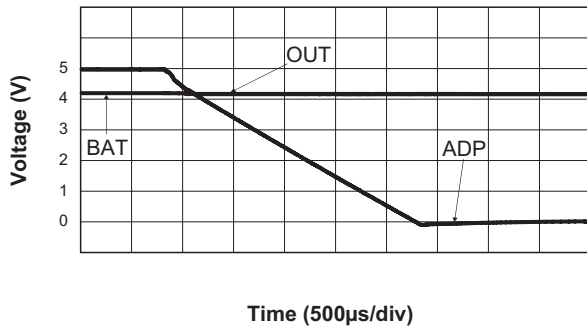

Transient Response of OUT
When Switching from BAT to ADP
($V_{ADP} = 0V \rightarrow 5V$)

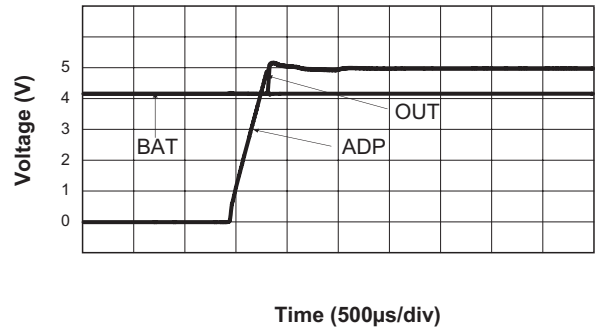

Transient Response of OUT
When Switching From USBH to BAT
($V_{USBH} = 5V \rightarrow 0V$; $R_{LOAD} = 7.8\Omega$)

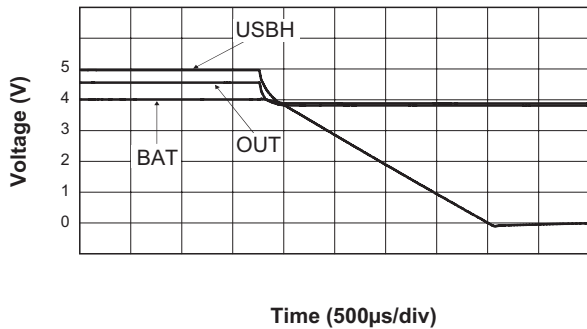

Transient Response of OUT
When Switching From BAT to USBH
($V_{USBH} = 0V \rightarrow 5V$; $R_{LOAD} = 7.8\Omega$)

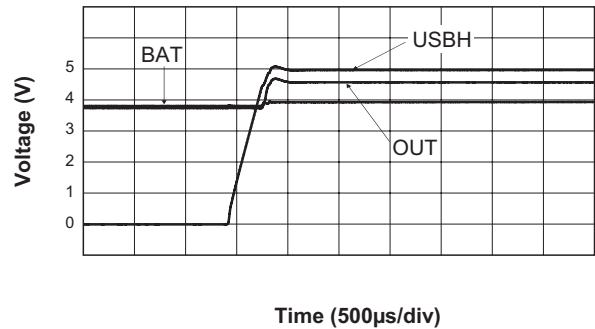

Typical Characteristics

**Transient Response of OUT
When Switching From USBL to BAT**
($V_{USBL} = 5V \rightarrow 0V$; $R_{LOAD} = 50\Omega$)

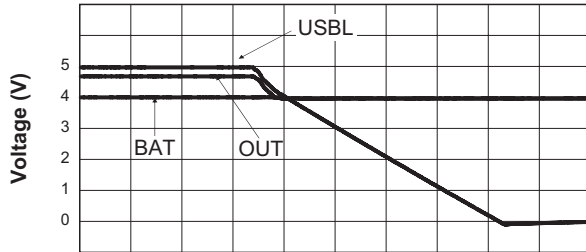

Time (500 μ s/div)

**Transient Response of OUT
When Switching From BAT to USBL**
($V_{USBL} = 0V \rightarrow 5V$; $R_{LOAD} = 50\Omega$)

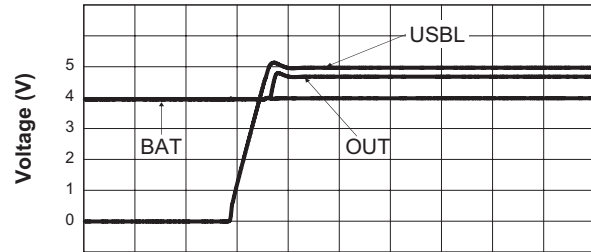

Time (500 μ s/div)

**Transient Response of OUT
When Switching From USBL to ADP**
($V_{ADP} = 5V \rightarrow 0V$; $R_{LOAD} = 50\Omega$)

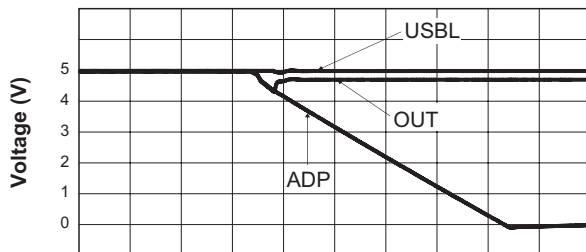

Time (500 μ s/div)

**Transient Response of OUT
When Switching From ADP to USBL**
($V_{ADP} = 0V \rightarrow 5V$; $R_{LOAD} = 50\Omega$)

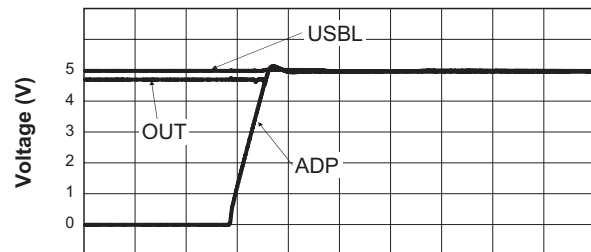

Time (500 μ s/div)

**Transient Response of OUT
When Switching From ADP to USBH**
($V_{ADP} = 0V \rightarrow 5V$; $R_{LOAD} = 7.8\Omega$)

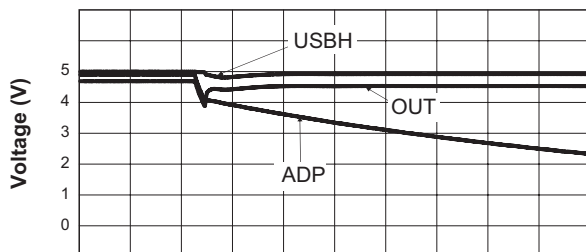

Time (100 μ s/div)

**Transient Response of OUT
When Switching From USBH to ADP**
($V_{ADP} = 5V \rightarrow 0V$; $R_{LOAD} = 7.8\Omega$)

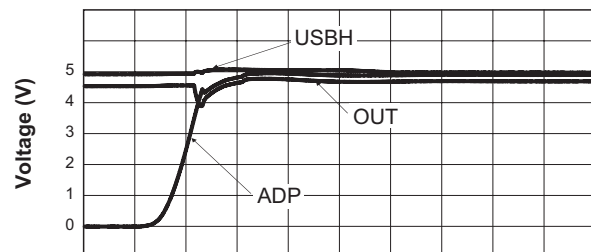

Time (100 μ s/div)

Typical Characteristics

**Transient Response of OUT When ADP is On
When USBH Switching from On to Off**
($V_{USBH} = 5V \rightarrow 0V$; $R_{LOAD} = 7.8\Omega$)

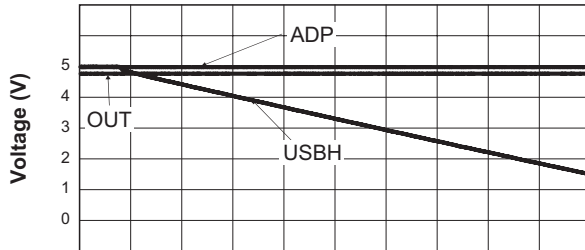

Time (500µs/div)

**Transient Response of OUT When ADP is On
When USBH Switching from Off to On**
($V_{USBH} = 0V \rightarrow 5V$; $R_{LOAD} = 7.8\Omega$)

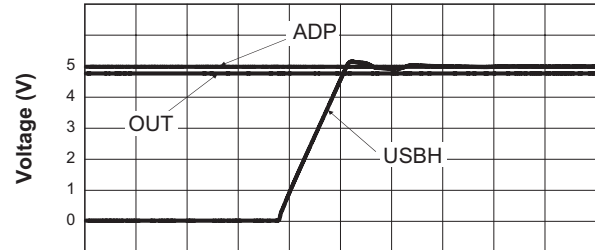

Time (500µs/div)

**Transient Response of OUT
When Switching From ADP to USBL**
($V_{USBL} = 5V \rightarrow 0V$; $R_{LOAD} = 50\Omega$)

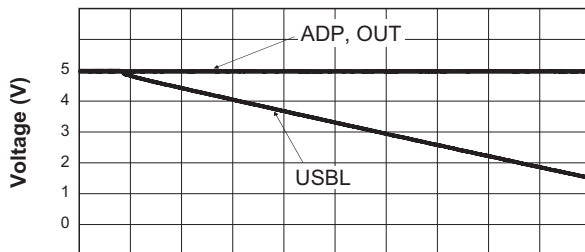

Time (500µs/div)

**Transient Response of OUT
When Switching From USBL to ADP**
($V_{USBL} = 0V \rightarrow 5V$; $R_{LOAD} = 50\Omega$)

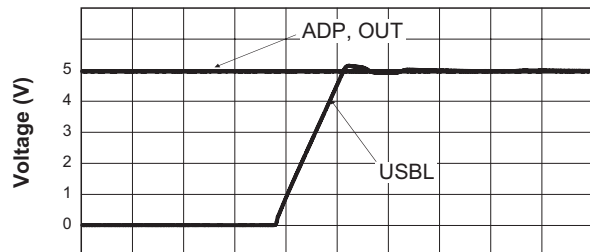

Time (500µs/div)

Functional Block Diagram

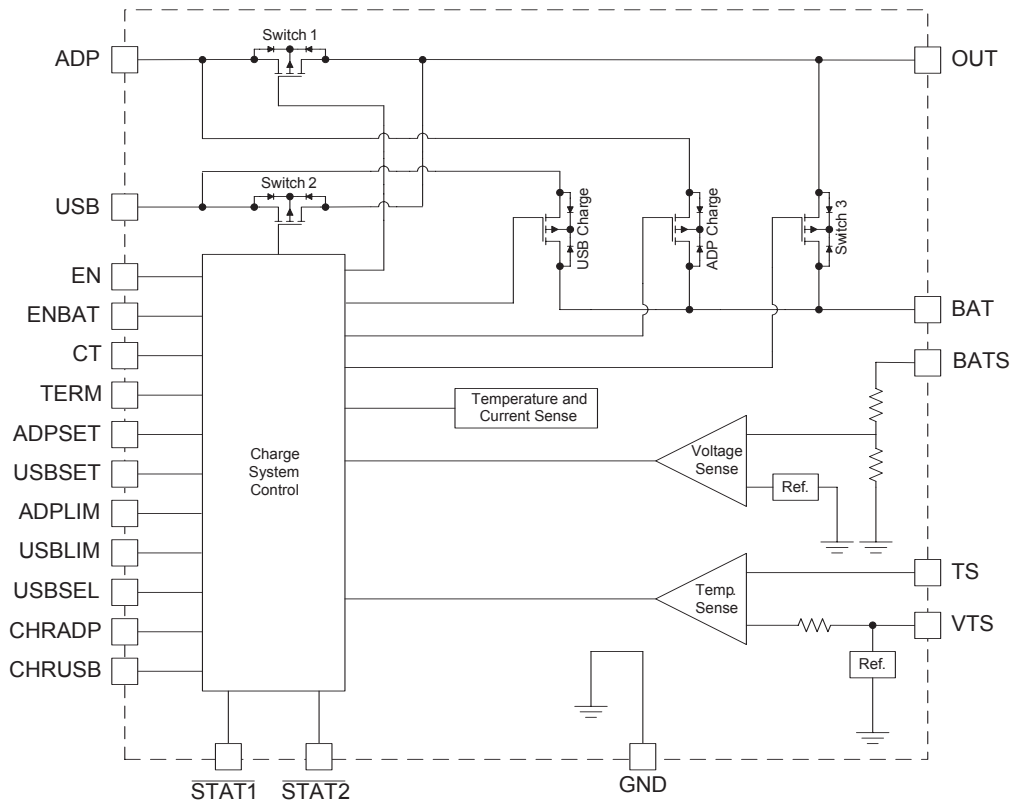

Functional Description

The AAT3670 is a dual input dynamic battery charge and power control IC. The dual input capability is designed to accommodate both AC power adapter and USB port power sources. In addition, this device also provides dynamic power control to charge a single cell Li-ion battery cell and power a system simultaneously.

The device contains separate charge regulation pass devices to control the charge current or voltage for both the adapter (ADP) and USB (USB) input power paths. The AAT3670 also contains three additional load switches to control and route input power to charge the battery, supply the system load and manage power from the battery to the system load. This charge control and switch array permits dynamic charging of the battery cell and control of power to the system load simultaneously.

When an input power source is applied to the AAT3670, the device selects the adapter or USB

input to provide power to the system load and charge the battery. If power is present on both the ADP and USB inputs, the system will select the ADP input since it provides greater power levels and charges the battery with a greater current. Without a valid ADP/USB supply present, the battery will power the system load as long as the battery voltage is greater than 2.9V. The battery voltage sense circuit will disconnect the battery from the load if the cell voltage falls below 2.9V to protect the battery cell from over-discharge which would result in shortened battery life.

The system load current drawn from the battery is limited internally. The AAT3670 precisely regulates battery charge voltage and current for 4.2V Li-ion battery cells, and the battery charge current can be programmed up to 1.6A for ADP charging and up to 0.9A for USB charging. During battery charge, the AAT3670 pre-conditions (trickle charge) the battery with lower current when the battery voltage is less than 2.9V, and it charges the battery in a constant current mode when the battery voltage is above

2.9V. When the battery voltage rises to 4.2V, the charger will automatically switch to a constant voltage mode until the charge current is reduced to the programmed charge termination current threshold. The internal arrangement of load switches and charge regulation device also provide dynamic power sourcing to the system load. If the system load exceeds the input current supply from the adapter or USB source, additional current can be sourced from the battery cell. At all times, the device will manage distribution of power between the source, the battery and the system simultaneously in order to support system power needs and charge the battery cell with the maximum amount of current possible.

The AAT3670 has a unique internal charge current reduction loop control that will prevent an input source from overload. In the case of USB charging from a USB port VBUS supply, there are two events which need to be guarded against. The first is charging from a defective or inadequate USB host supply; the second problem could arise if the programmed USB charge current plus the system supply demand through the AAT3670 exceeds the ability of a given USB port. In either case, the AAT3670 charge reduction (CHR) loop will activate when the input source to the USB input drops below the V_{CHR_TH} threshold of 4.5V. The CHR loop will automatically reduce the charge current to the battery until the supply voltage recovers to a point above the V_{CHR_TH} threshold. The CHR loop protection system also operates in the adapter input mode with a 4.6V V_{CHR_TH} threshold. This protects the charger, system and source supply in the event an adapter or power source does not meet the ADP charging mode specification. In USB or adapter mode charging, the CHR system will permit the charging of a battery cell with the maximum possible amount of charge current for any given source fault condition.

During battery charging, the device temperature will rise. In some cases with adapter (ADP) charging, the power dissipation in the device may cause the junction temperature to rise to close to its thermal shutdown threshold. In the event of an internal over-temperature condition caused by excessive ambient operating temperature or excessive power dissipation condition, the AAT3670 enables a digitally controlled thermal loop system that will reduce

the charging current to prevent the device from thermal shutdown. The digital thermal loop will maintain the maximum possible battery charging current for the given set of input to output power dissipation and ambient temperature conditions. The digital thermal loop control is dynamic in the sense that it will continue to adjust the battery charging current as operating conditions change. The digital thermal loop will reset and resume normal operation when the power dissipation or over-temperature conditions are removed.

Battery temperature and charge state are fully monitored for fault conditions. In the event of an over-voltage, over-current, or over-temperature failure, the device will automatically shut down, thus protecting the charging device, control system, and the battery under charge. In addition to internal charge controller thermal protection, the AAT3670 also provides a temperature sense feedback function (VTS/TS pins) from the battery to shut down the device in the event the battery exceeds its own thermal limit during charging. All fault events are reported to the user by two simple status LEDs.

Charging Operation

The AAT3670 has four basic modes for the battery charge cycle regardless of which charge input function is selected, either the adapter input or USB input: pre-conditioning/trickle charge, constant current fast charge, constant voltage, and end of charge/sleep mode.

Battery Preconditioning

Before the start of charging, the AAT3670 checks several conditions in order to assure a safe charging environment. The input supply must be above the minimum operating voltage, or under-voltage lockout threshold (V_{UVLO}), for the charging sequence to begin. Also, the cell temperature, as reported by a thermistor connected to the TS pin from the battery, must be within the proper window for safe charging. When these conditions have been met and a battery is connected to the BAT pin, the AAT3670 checks the state of the battery via the battery voltage sensing (BATS) pin. If the cell voltage is below the preconditioning voltage threshold (V_{MIN}), the AAT3670 begins preconditioning the cell.

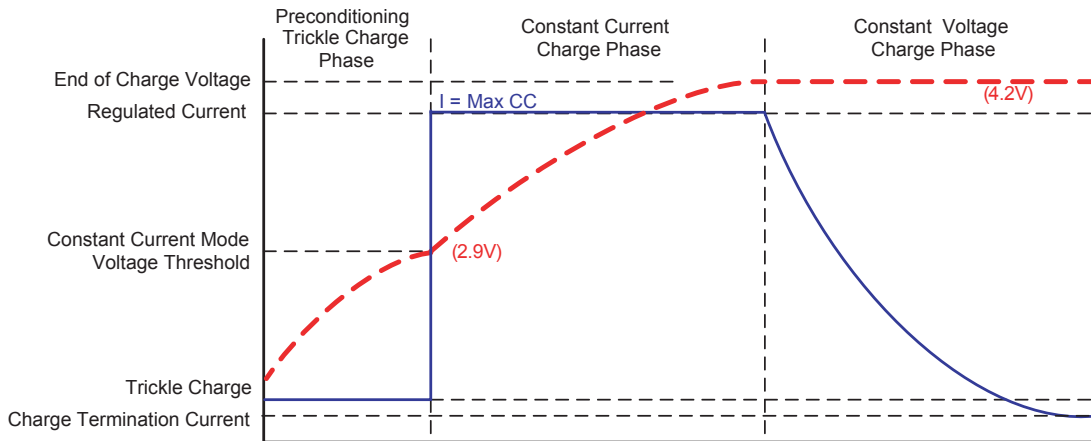

Figure 1: Current vs. Voltage Profile During Charging Phases.

The battery preconditioning trickle charge current is equal to the fast charge constant current divided by 10 for the adapter and USB high input modes. For example, if the programmed fast charge current is 500mA, then the preconditioning mode (trickle charge) current will be 50mA. In the USB low charging mode, the preconditioning current is set to the programmed fast charge current divided by two. Cell preconditioning is a safety precaution for a deeply discharged battery and also aids in limiting power dissipation in the charge control pass transistor when the voltage across the device is at the greatest potential.

Fast Charge/Constant Current Charging

Battery cell preconditioning continues until the voltage measured by the battery sense (BATS) pin exceeds the preconditioning voltage threshold (V_{MIN}). At this point, the AAT3670 begins constant-current charging fast charging phase. The fast charge constant current (I_{CC}) level is determined by the charge mode (ADP, USBH or USBL) and is programmed by the user via the R_{ADPSET} and $R_{USBLSET}$ resistors. The AAT3670 remains in constant current charge mode until the battery reaches the voltage regulation point, V_{BAT_EOC} .

Constant Voltage Charging

The charge control system transitions to a regulated constant voltage charging mode when the battery

voltage reaches output charge regulation threshold (V_{BAT_EOC}) during constant current fast charge phase. The regulation voltage level is factory programmed to 4.2V ($\pm 1\%$). The charge current in the constant voltage mode drops as the battery cell under charge reaches its maximum capacity.

End of Charge Cycle Termination and Recharge Sequence

When the charge current drops to the user programmed charge termination current at the end of the constant voltage charging phase, the device terminates charging and enters the sleep state. The charger will remain in the sleep state until the battery voltage decreases to a level below the battery recharge voltage threshold (V_{RCH}). The charge termination current is programmed via the R_{TERM} resistor.

When the input supply is disconnected, the charger also automatically enters power-saving sleep mode. Only consuming an ultra-low $1\mu A$ in sleep mode, the AAT3670 minimizes battery drain when not charging. This feature is particularly useful in applications where the input supply level may fall below the usable range of the charge reduction control or under-voltage lockout level. In such cases where the AAT3670 input voltage drops, the device will enter the sleep mode and automatically resume charging once the input supply has recovered from its fault condition.

Applications Information

AC Adapter/USB System Power Charging

Adapter Input Mode

In the adapter mode, constant current charge levels up to 1.6A may be programmed by the user. The AAT3670 system control will always select the adapter input over the USB supply input when ever voltage is present on the ADP pin. The ADP input will operate over a range from 4.35V to 5.5V.

The constant fast charge current for the adapter input mode is set by the R_{ADPSET} resistor connected between the ADPSET pin and ground. The battery preconditioning or trickle charge current is fixed at 10% of the programmed fast charge constant current level. Refer to Table 2 for recommended R_{ADPSET} values for a desired constant current charge level. Battery charging states will be indicated via the STAT1 and STAT2 display LEDs. Please refer to the Battery Charge Status Indication discussion for further details on data reporting.

ADP Charge Reduction

Under normal operation, the AAT3670 should be operated from an adapter power source with a sufficient capacity to supply the desired constant charge current plus any additional load which may be placed on the source by the operating system. In the event that the power source to the ADP pin is unable to provide the programmed fast charge constant current, or if the system under charge must also share supply current with other functions, the AAT3670 will automatically reduce the ADP fast charge current level to maintain the integrity of the source supply, power the operating system, and charge the battery cell with the remaining available current.

The ADP charge reduction system becomes active when the voltage on the ADP input falls below the ADP charge reduction threshold (V_{CHRADP}), which is preset to 4.6V. Should the input supply drop below the V_{CHRADP} threshold, the charge reduction system will reduce the fast charge current level in a linear fashion until the voltage sensed on the ADP input recovers to a point above the charge reduction threshold voltage. The ADP charge reduction threshold (V_{CHRADP}) may be externally set to a value other than 4.6V by placing a resistor divider network between the ADP pin and ground with the center

connected to the CHRADP pin. The ADP charge reduction feature may be disabled by shorting the CHRADP pin directly to the ADP input pin.

The following equation may be used to approximate the ADP charge reduction threshold above or below 4.5V:

$$\text{Eq. 1: } V_{ADPCHR} = \frac{2.0V}{(R12/[R12 + R11])}$$

where $R11$ and $R12 < 500k\Omega$.

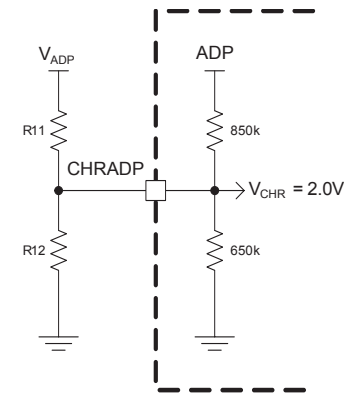

Figure 2: Internal Equivalent Circuit for the CHRADP Pin.

Adapter Input Charge Inhibit and Resume

The AAT3670 has an under-voltage lockout (UVLO) and power on reset feature to protect the charger IC in the event the input supply to the adapter pin drops below the UVLO threshold. Under a UVLO condition, the charger will suspend the charging process. When power is re-applied to the adapter pin or the UVLO condition recovers, the system charge control will assess the state of charge on the battery cell and will automatically resume charging in the appropriate mode for the condition of the battery.

USB Input Mode

The AAT3670 provides an input for intelligent USB charging. When no voltage is present on the adapter input pin, the charge controller will automatically switch to accepting power from the USB input. The USB charge mode provides two programmable fast charge levels, USB high (USBH)

and USB low (USBL). The USBH mode can be set as high as 900mA; however for most applications utilizing a USB port as the source supply, 500mA is the typical default USBH value and USBL is subsequently set for 100mA. In the USBL fast charge mode, the constant charging current is set to 20 percent of the programmed USBH. More simply put, the USBL low fast charge level = USBH divided by five. The USBH or USBL modes may be externally selected by USB select pin (USBSEL).

In the USBH mode, the battery cell preconditioning or trickle charge current is fixed at 10 percent of the programmed fast charge constant current. In the USBL mode, the trickle charge current is only reduced to 50 percent of the programmed fast charge constant current level.

When the USBSEL pin is connected to a logic high level, the USBH level will be active. Conversely, when USBSEL is pulled to a logic low level (ground) the USBL level will be used for fast charging. Refer to Table 2 for the recommended R_{USBSET} value to program the desired USB input constant current charge levels.

USB Charge Reduction

In many instances, product system designers have an issue of not knowing the real properties of a potential USB port to be used to supply power to the battery charger. Typical powered USB ports commonly found on desktop and notebook PCs should supply up to 500mA. In the event a USB port being used to supply the charger is unable to provide the programmed fast charge current, or if the system under charge must also share supply current with other functions causing an overload to the USB port, the AAT3670 will automatically reduce USB fast charge current to maintain port integrity and protect the host system.

The USB charge reduction system becomes active when the voltage on the USB input falls below the USB charge reduction threshold (V_{CHRUSB}), which is typically 4.5V. Regardless of which USB charge function is selected (USBH or USBL), the charge reduction system will reduce the fast charge current level in a linear fashion until the voltage sensed on the USB input recovers above the charge reduction threshold voltage. The USB charge reduction threshold (V_{CHRUSB}) may be externally set to a value lower than 4.5V by placing a resistor divider network

between V_{USB} and ground with the center connected to the CHRUSB pin. The USB charge reduction feature may be disabled by shorting the CHRUSB pin directly to the USB input pin.

The following equation may be used to approximate a USB charge reduction threshold below 4.5V:

$$\text{Eq. 2: } V_{USBCHR} = \frac{2.0V}{(R2/[R2 + R1])}$$

where $R1$ and $R2 < 1M\Omega$

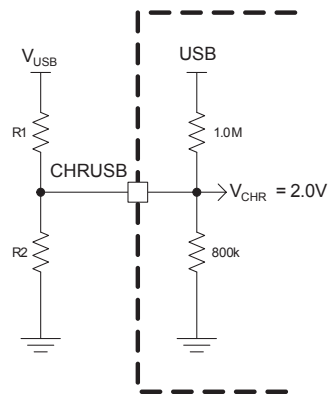

Figure 3: Internal Equivalent Circuit for the CHRUSB Pin.

USB Input Charge Inhibit and Resume

The AAT3670 under-voltage lockout (UVLO) and power-on reset feature will function when the USB input pin voltage level drops below the UVLO threshold. At this point the charger will suspend charging. When power is re-applied to the USB pin or the UVLO condition recovers, the system charge control will assess the state of charge on the battery cell and will automatically resume charging in the appropriate mode for the condition of the battery.

End of Charge Termination

The AAT3670 provides a user-programmable charge termination current at the end of the charge cycles. When the battery cell voltage as sensed by the BATS pin reaches 4.2V, the charge control will transition from constant current fast charge mode to constant voltage mode. In constant voltage mode, the battery cell voltage will be regulated at 4.2V. The charge current will drop as the battery reaches its full charge capacity. When the charge current

drops to the programmed end of charge (EOC) current, the charge cycle is complete and the charge controller terminates the charging process.

The charge termination current is user programmed by the value of R_{TERM} , which is connected between the TERM pin and ground. Use the values listed in Table 1 to set the desired charge termination current. The programmed charge termination current will remain at the same set level regardless of which fast charge ADP, USBH or USBL constant current mode is selected.

I_{TERM} (mA)	R_{TERM} (k Ω)
320	11.0
174	21.0
125	30.9
95	41.2
77	51.1
64	61.9
58	71.5
50	80.6
49	90.9
42	100.0
37	110.0

Table 1: Charge Termination Current Programming Resistor Values.

If the desired end of charge termination current level is not listed in Table 1, the TERM resistor value may be calculated by the following equation:

For the Adapter input mode:

$$R_{TERM} = K \cdot \left(\frac{V_{TERM}}{I_{CC}} \right)$$

Where:

$$K = K_{I_{TERM}} = 2000$$

$$V_{TERM} = 2V$$

$$I_{CC} = \text{Fast charge constant current}$$

The constants K and V_{TERM} are specified in the Typical Characteristics section of this datasheet.

The end-of-charge termination current function can be disabled by pulling the TERM pin high via connecting the TERM pin to the BAT pin. In this state,

the end-of-charge function will be disabled and the battery will float charge in the constant voltage mode indefinitely or until the cell voltage is brought below the constant voltage threshold.

System Power Output

The power to the system is supplied via the OUT pin. OUT will source power from either the ADP or USB inputs when an external power source is applied. When the battery charging function is complete and the charging power source is removed, the system will be powered from the battery via Load Switch 3, referring to the AAT3670 block diagram. The maximum current that can be supplied from the ADP or USB inputs to a system load is bounded by the user programmed ADPLIM and USBLIM level. If the current consumption from the system load exceeds that of the ADP or USB input sources, the IC will draw current from the battery to make up the difference as long as the battery cell voltage remains above 2.9V. Power from the battery to the OUT pin is controlled by the ENBAT function. When the ENBAT is disabled the leakage current from the battery to the load is less than 1 μ A.

Battery Connection and Battery Voltage Sensing

Battery Connection

The single cell Li-ion battery should be connected between the BAT pin and ground. The internal load switching network will connect the battery to the system load and apply the charging current.

Battery Voltage Sensing

The BATS pin is provided to employ an accurate voltage sensing capability to measure the terminal voltage at the battery cell being charged. This function reduces measured battery cell voltage error between the battery terminal and the charge control IC. The AAT3670 charge control circuit will base charging mode states upon the voltage sensed at the BATS pin. The BATS pin must be connected to the battery terminal for correct operation. If the battery voltage sense function is not needed, the BATS pin should be terminated directly to the BAT pin. If there is concern of the battery sense function inadvertently becoming an open circuit, the BATS pin may be terminated to the BAT pin using a 10 Ω resistor. Under normal operation, the connection to the battery ter-

minal will be close to 0Ω; if the BATS connection becomes an open circuit, the 10Ω will provide feedback to the BATS pin from the BAT connection will a 1mV or less loss in sensed voltage accuracy.

Enable

The AAT3670 provides an enable function to control the charger IC on and off. The enable (EN) pin is active high. When pulled to a logic low level, the AAT3670 will be shut down and forced into the sleep state. Charging will be halted regardless of the battery voltage or charging state. When the device is re-enabled, the charge control circuit will automatically reset and resume charging functions with the appropriate charging mode based on the battery charge state and measured cell voltage.

Battery Enable

Since the AAT3670 provides battery power switching as well as charging function, a battery enable pin (ENBAT) is provided so the power from the battery via the BAT pin to the OUT pin may be externally controlled. The ENBAT function allows the user to control power to the systems regardless of charging state, input power source, or charge enable (EN) state.

It may be desirable for some system designs to disconnect the battery from the load during charging. This may be accomplished by pulling the ENBAT pin low, while the device is enabled for charging (EN high).

Programming Charge Current

The fast charge constant current charge level for both adapter and USB input modes are programmed with set resistors placed between the ADPSET or USBSET pins and ground. The accuracy of the fast charge constant current and the preconditioning trickle charge current are dominated by the tolerance of the set resistor used. For this reason, 1% tolerance metal film resistors are recommended for this set resistor function.

Fast charge constant current levels from 50mA to 1.6A may be set by selecting the appropriate resistor value from Table 2. The R_{ADPSET} resistor should be connected between the ADPSET pin and ground.

The USB input fast charge constant current charge control provides up to 900mA of charge current and is set in the USBH mode. The USBSEL pin is used to select the high or low charge current levels in the

USB charge mode. When the USBSEL pin is pulled to a voltage level above the $V_{USBSEL(H)}$ threshold, the USBH current level will be selected. Conversely, this pin should be pulled below the $V_{USBSEL(L)}$ threshold to enable the USBL charge level; the USBL charge current will be set to 20% of the set USBH level. For typical USB charging applications, the USBH and USBL functions are fixed for 500mA and 100mA USB fast charge levels. However, the charge level of USBH may be set from 50mA to 900mA and USBL will in turn be fixed at 20% of the USBH level depending upon the system design requirements for a given USB charge application. Refer to Table 2 and Figure 4 for recommended R_{USBSET} values.

I_{CC} (mA)	ADP R_{SET} (kΩ)	USBH R_{SET} (kΩ)	USBL R_{SET} (kΩ)
50	1300	750	150
90	681	453	80.6
100	590	383	71.5
150	412	249	47.5
200	309	187	34.8
250	249	150	
300	205	124	
400	154	90.9	
500	121	71.5	
650	93.1	54.9	
800	73.2	43.2	
900	64.9	38.3	
1000	57.6		
1200	48.7		
1500	38.3		
1600	34.8		

Table 2: R_{SET} Values.

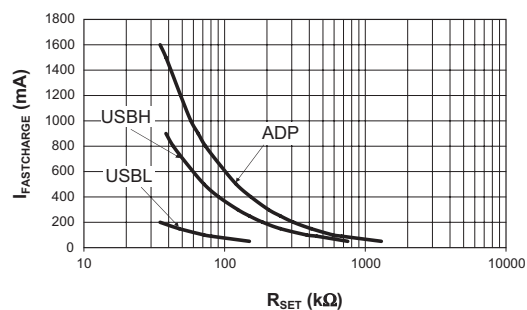

Figure 4: Fast Charge Current vs. Set Resistor ($V_{IN} = 5V$; $V_{BAT} = 3.5V$).

If the desired current charge current level is not listed in Table 2, the ADPSET and USBSET resistor values may be calculated by the following equations:

For the Adapter input mode:

$$R_{ADPSET} = K \cdot \left(\frac{V_{ADPSET}}{I_{CC}} \right)$$

Where:

$$K = K_{I_{CCADP}} = 29300$$

$$V_{ADPSET} = 2V$$

$$I_{CC} = \text{Fast Charge Constant Current}$$

For the USB input mode:

$$R_{USBSET} = K \cdot \left(\frac{V_{USBSET}}{I_{CC}} \right)$$

Where:

$$K = K_{I_{CCUSBH}} = 17900 \text{ (USBH)}$$

$$K = K_{I_{CCUSBL}} = 3600 \text{ (USBL)}$$

$$V_{USBSET} = 2V$$

$$I_{CC} = \text{Fast Charge Constant Current}$$

All constants K and $V_{ADP/USBSET}$ are specified in the Typical Characteristics section of this datasheet.

Protection Circuitry

Thermal Loop Control

Due to the integrated nature of the linear charging control pass devices for both the adapter and USB modes, a special thermal loop control system has been employed to maximize charging current under all operating conditions. The thermal management system measures the internal circuit die temperature and reduces the charge current when the device exceeds a preset internal temperature control threshold. Once the thermal loop control becomes active, the constant charge current is initially reduced by a factor of 0.44.

The initial thermal loop current can be estimated by the following equations:

$$\text{In ADP mode: } I_{TLOOP} = I_{CCADP} \cdot 0.44$$

$$\text{In USB mode: } I_{TLOOP} = I_{CCUSBH} \cdot 0.44$$

The thermal loop control re-evaluates the internal die temperature every three seconds and adjusts the fast charge current back up in small steps up to the full fast charge current level or until an equilibrium current is discovered and maximized for the given ambient temperature condition. In this manner, the thermal loop controls the system charge level. The AAT3670 will always provide the highest possible level of constant current in the fast charge mode for any given ambient temperature condition.

Programmable Watchdog Timer

The AAT3670 contains a watchdog timing circuit which operates only in adapter charging mode. Typically a 0.1 μ F ceramic capacitor is connected between the CT pin and ground. When a 0.1 μ F ceramic capacitor is used, the device will time a shutdown condition if the trickle charge mode exceeds 45 minutes. When the device transitions to the trickle charge to the fast charge constant current mode and then to the constant voltage mode, the timing counter is reset and will time out after 3 hours for each mode.

Summary for a 0.1 μ F used for the timing capacitor:

Trickle Charge (TC) time out = 45 minutes

Fast Charge Constant Current (CC) time out = 3 hours

Constant Voltage (VC) mode time out = 3 hours

The CT pin is driven by a constant current source and will provide a linear response to increases in the timing capacitor value. Thus, if the timing capacitor were to be doubled from the nominal 0.1 μ F value, the time out time of the CC + CV modes would be doubled. The corresponding trickle charge time out time would be the combined CC + VC time divided by 8.

If the programmable watchdog timer function is not needed it may be disabled by terminating the CT pin to ground. The CT pin should not be left floating or un-terminated; this will cause errors in the internal timing control circuit.

The charge timer control will suspend the timing count in any given mode in the event a fault condition occurs. Such fault conditions include digital thermal loop charge current reduction, ADP or USB charge reduction, battery temperature fault, and battery current sharing with the output during the charging cycle. When the fault condition recovers, the counter will resume the timing function. The charge timer will automatically reset when the AAT3670 enable pin is reset or cycled off and on.

The constant current provided to charge the timing capacitor is very small and this pin is susceptible to noise and changes in capacitance value. Therefore, the timing capacitor should be physically located on the printed circuit board layout as close as possible to the CT pin. Since the accuracy of the internal timer is determined by the capacitance value, a 10% tolerance or better ceramic capacitor is recommended. Ceramic capacitor materials such as X7R and X5R type are a good choice for this application.

Over-Current Protection

The AAT3670 provides over-current protection to both the battery and system output modes for both the ADP and USB input sources.

The over-current protection threshold is user programmable and independent from the constant charge current setting. The set resistor R_{ADPLIM} is connected between the ADPLIM pin and ground to program the ADP power path current limit up to 1.6A. The set resistor R_{USBLIM} is connected between the USBLIM pin and ground to program the USB power path current limit up to 900mA. For both the ADP and USB charge paths, the programmed constant current fast charge level may not exceed the respective ADPLIM and USBLIM set points. Refer to Table 3 for the ADPLIM and USBLIM programming resistor values.

I_{CC} (mA)	R_{ADPLIM} (k Ω)	R_{USBLIM} (k Ω)
50	1300	750
90	681	453
100	590	383
150	412	249
200	309	187
250	249	150
300	205	124
400	154	90.9
500	121	71.5
650	93.1	54.9
800	73.2	43.2
900	64.9	38.3
1000	57.6	
1200	48.7	
1500	38.3	
1600	34.8	

Table 3: Current Limit Programming Resistor Values.

If the desired charge current limit level is not listed in Table 3, the ADPLIM and USBLIM set resistor values may be calculated by the following equations:

For the Adapter input mode:

$$R_{ADPLIM} = K \cdot \left(\frac{V_{ADPLIM}}{I_{CC}} \right)$$

Where:

$$K = K_{I_LIM_ADP} = 27800$$

$$V_{ADPLIM} = 2V$$

$$I_{CC} = \text{Fast Charge Constant Current}$$

For the USB input mode:

$$R_{USBLIM} = K \cdot \left(\frac{V_{USBLIM}}{I_{CC}} \right)$$

Where:

$$K = K_{I_LIM_USBH} = 17600 \text{ (USBH)}$$

$$K = K_{I_LIM_USBL} = 3500 \text{ (USBL)}$$

$$V_{USBLIM} = 2V$$

$$I_{CC} = \text{Fast Charge Constant Current}$$

All constants K and $V_{ADP/USBLIM}$ are specified in the Typical Characteristics section of this datasheet.

Over-Voltage Protection

An over-voltage event is defined as a condition where the voltage on the BATS pin exceeds the maximum battery charge voltage and is set by the over-voltage protection threshold (V_{OVP}). If an over-voltage condition occurs, the AAT3670 charge control will shutdown the device until voltage on the BATS pin drops below the over-voltage protection threshold (V_{OVP}). The AAT3670 will resume normal charging operation once the battery over-voltage condition is removed. During an over-voltage event, the STAT2 LED will report a system fault.

Over-Temperature Shutdown

The AAT3670 has a thermal protection control circuit which will shut down charging functions should the internal die temperature exceed the preset thermal limit threshold.

Battery Temperature Fault Monitoring

In the event of a battery over-temperature condition, the charge control will turn off the internal charge path regulation device and report the fault condition via the STAT2 display LED. After the system recovers from a temperature fault, the device will resume charging operation. The AAT3670 checks battery temperature before starting the charge cycle, as well as during all stages of charging.

Typically, batteries employ the use of a negative temperature coefficient (NTC) thermistor that is integrated into the battery package. Most commonly used NTC thermistors used in battery packs are approximately $10k\Omega$ at room temperature (25°C). However, the AAT3670 TS pin, in conjunction with the VTS pin, permits the use of almost any value of NTC thermistor.

There are two pins associated with the battery temperature sensing function, TS and VTS. The battery pack thermistor should be connected between the TS pin and ground. The VTS pin is provided to allow the user to program battery temperature sense thresholds depending upon the value of the NTC thermistor used in a given battery pack. A resistor (R_T) connected between the VTS pin and the TS pin will set a bias for the NTC thermistor function. The TS function has been designed such that a default NTC thermistor value of $10k\Omega$ will then require a $10k$

resistor for R_T . To determine the actual operating temperature window for the the NTC thermistor and the TS pin, one must first specify the NTC thermistor to be used, then refer to the thermistor datasheet to determine its characteristics.

The internal battery temperature sensing system is comprised of two comparators which establish a voltage window for safe operation. The thresholds for the TS operating window are bounded by the TS1 and TS2 specifications. Referring to the electrical characteristics table in this datasheet, the TS1 threshold = $0.30 \cdot V_{VTS}$ and the TS2 threshold = $0.72 \cdot V_{VTS}$. The VTS pin is capable of sourcing up to 2mA.

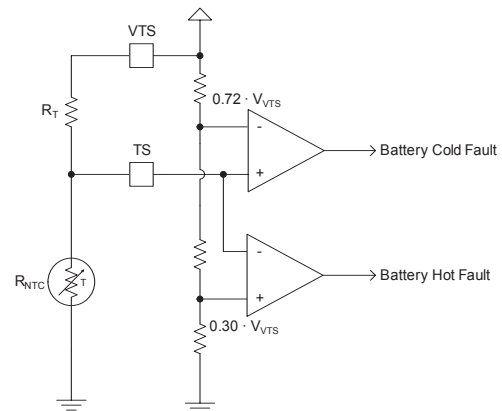

Figure 5: Battery Temperature Sense Circuit.

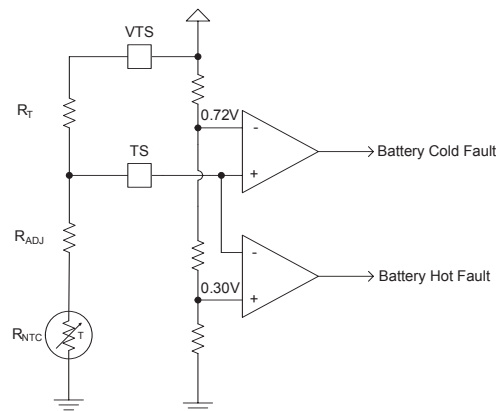

Figure 6: Battery Temperature Sense Circuit with Externally Adjusted Window Threshold.

If the use of the battery temperature sense function is not required, it may be disabled by disconnecting the VTS pin from the TS pin and terminating the TS pin to ground. The VTS pin can be left floating.

Battery Charge Status Indication

The AAT3670 indicates the status of the battery under charge using two status LED driver outputs. These two LEDs can indicate simple functions such as no battery charge activity, battery charging, charge complete and charge fault.

Status Indicator Display

System charging status may be displayed using one or two LEDs in conjunction with the STAT1 and STAT2 pins on the AAT3670. These two pins are simple switches to connect the status LED cathodes to ground. It is not necessary to use both display LEDs if a user simply wants to have a single lamp to show "charging" or "not charging". This can be accomplished by using the STAT1 pin and a single LED. Using two LEDs and both STAT pins simply gives the user more information for the various charging states. Refer to Table 4 for LED display definitions.

The LED anodes should be connected to USB, ADP, BAT, or OUT depending upon the system design requirements. The LEDs should be biased with as little current as necessary to create reasonable illumination. A ballast resistor should be placed between the status LED cathodes and the STAT1/2 pins. LED current consumption will add to the over thermal power budget for the device package, hence it is good reason to keep the LED drive current to a minimum. 2mA should be sufficient to drive most common low cost green or red LEDs. It is not rec-

ommended to exceed 8mA for driving an individual status LED. The required ballast resistor value can be estimated using the following formulas:

For connection to the adapter supply:

$$\text{Eq. 3: } R_{B(\overline{\text{STAT1/2}})} = \frac{(V_{\text{ADP}} - V_{F(\text{LED})})}{I_{\text{LED}(\overline{\text{STAT1/2}})}}$$

Example: $R_{B(\overline{\text{STAT1}})} = (5.5\text{V} - 2.0\text{V}) / 2\text{mA} = 1.75\text{k}\Omega$

Note: Red LED forward voltage (V_F) is typically 2.0V @ 2mA.

For connection to the USB supply:

$$\text{Eq. 4: } R_{B(\overline{\text{STAT1/2}})} = \frac{(V_{\text{USB}} - V_{F(\text{LED})})}{I_{\text{LED}(\overline{\text{STAT1/2}})}}$$

Example: $R_{B(\overline{\text{STAT2}})} = (5.0\text{V} - 3.2\text{V}) / 2\text{mA} = 900\Omega$

Note: Green LED forward voltage (V_F) is typically 3.2V @ 2mA.

For connection to the BAT supply:

$$\text{Eq. 5: } R_{B(\overline{\text{STAT1/2}})} = \frac{(V_{\text{BAT}} - V_{F(\text{LED})})}{I_{\text{LED}(\overline{\text{STAT1/2}})}}$$

Example: $R_{B(\overline{\text{STAT2}})} = (3.6\text{V} - 3.2\text{V}) / 2\text{mA} = 200\Omega$

Note: Green LED forward voltage (V_F) is typically 3.2V @ 2mA.

Event Description	STAT1
End of Charge (TERM Current Reached in CVM), Battery OV, Timeout, or Charge Disabled	OFF
No Battery (With Charge Enabled)	Flash (1Hz, 40% duty)
Battery Charging (Including Suspended Charging Due to Battery OT/UT, or Device OT)	ON
Event Description	STAT2
Charge Disabled, No Battery, End of Charge, or Charging Without Faults	OFF
Faults (Battery OV/OT/UT, or Device OT) or Timeout	ON

Table 4: LED Status Indicator (STATx Pulled Up to a Voltage Source with Resistors and LED).

No Battery Present Indication

If the AAT3670 charger IC is powered and enabled from either the ADP or USB input, yet no battery is connected to the BAT and BATS pins, the STAT1 LED will flash at a 1Hz rate with an approximate 40% duty cycle when a 10μF capacitor is connected between the BAT pin and ground. The flash rate of the STAT1 LED can be adjusted by changing the value of the battery output (BAT pin) capacitor. If the capacitor value is increased above 20μF, the no battery detect flashing function will be defeated.

The flash rate of the no battery detect function may be approximated by the following equation:

$$\text{Eq. 6: } C = \frac{I \cdot T}{V}$$

Where:

C = Capacitor value

I = Start up source current from the BAT pin = 5μA

V = Difference voltage between the end of charge voltage and the battery recharge threshold = 0.2V

T = Rate of LED flashing in seconds

Thermal Considerations

The AAT3670 is available in a 4x4mm 24-pin QFN package which can provide up to 2.0W of power dissipation when it is properly bonded to a printed circuit board, but can achieve a maximum thermal resistance of 37°C/W with printed circuit board enhancement. Many considerations should be taken into account when designing the printed circuit board layout as well as the placement of the charger IC package in proximity to other heat generating devices in a given application design. The ambient temperature around the charger IC will also have an effect on the thermal limits of a battery charging application. The maximum limits that can be expected for a given ambient condition can be estimated by the following discussion:

First, the maximum power dissipation for a given situation should be calculated:

$$\text{Eq. 7: } P_D = [(V_{IN} - V_{BAT}) \cdot I_{CC} + (V_{IN} \cdot I_{OP}) + (I_{OUT}^2 \cdot R_{DS(ON)})]$$

Where:

P_D = Total power dissipation by the device

V_{IN} = either V_{ADP} or V_{USB} , depending on which mode is selected

V_{BAT} = Battery voltage as seen at the BAT pin

I_{CC} = Maximum constant fast charge current programmed for the application

I_{OP} = Quiescent current consumed by the charger IC for normal operation

I_{OUT} = Load current to system from the OUT pin

$R_{DS(ON)}$ = On-resistance of load switch between ADP or USB and OUT

Next, the maximum operating ambient temperature for a given application can be estimated based on the thermal resistance of the 4x4 QFN package when sufficiently mounted to a PCB layout and the internal thermal loop temperature threshold.

$$\text{Eq. 8: } T_A = T_J - (\theta_{JA} \cdot P_D)$$

Where:

T_A = Ambient temperature in °C

T_J = Maximum device junction temperature below the thermal loop threshold

P_D = Total power dissipation by the device

θ_{JA} = Package thermal resistance in °C/W

Example:

For an application where the fast charge current for the adapter mode is set to 1A, $V_{ADP} = 5.0V$, and the worst-case battery voltage at 3.0V with the system load disabled, what is the maximum ambient temperature where the thermal limiting will become active?

Given:

$$V_{ADP} = 5.0V$$

$$V_{BAT} = 3.0V$$

$$I_{CC} = 1A$$

$$I_{OP} = 0.75mA$$

$$T_J = 110^\circ C$$

$$\theta_{JA} = 37^\circ C/W$$

$$I_{OUT} = 0$$

$$R_{DS(ON)} = 0.4\Omega$$

Using Equation 7, calculate the device power dissipation for the stated condition:

$$\begin{aligned} \text{Eq. 9: } P_D &= (5.0V - 3.0V)(1A) + (5.0V \cdot 0.75mA) + (0^2 \cdot 0.4\Omega) \\ &= 2.00375W \end{aligned}$$

The maximum ambient temperature before the AAT3670 thermal loop becomes active can now be calculated using Equation 8:

$$\begin{aligned} \text{Eq. 10: } T_A &= 110^\circ C - (37^\circ C/W \cdot 2.00375W) \\ &= 35.86^\circ C \end{aligned}$$

Therefore, under the stated conditions for this worst-case power dissipation example, the AAT3670 will enter the thermal loop and lower the fast charge constant current when the ambient operating temperature rises above 35.86°C.

Capacitor Selection

Input Capacitor

In general, it is good design practice to place a decoupling capacitor between the ADP and USB pins and ground. An input capacitor in the range of 1 μ F to 22 μ F is recommended. If the source supply is unregulated, it may be necessary to increase the capacitance to keep the input voltage above the under-voltage lockout threshold during device enable and when battery charging is initiated.

If the AAT3670 adapter input is to be used in a system with an external power supply source, such as a typical AC-to-DC wall adapter, then a C_{IN} capacitor in the range of 10 μ F should be used. A larger input capacitor in this application will minimize switching or power bounce effects when the power supply is "hot plugged" in. Likewise, a 10 μ F or greater input capacitor is recommended for the USB input to help buffer the effects of USB source power switching, noise and input cable impedance.

Output Capacitor

The AAT3670 only requires a 1 μ F ceramic capacitor on the BAT pin to maintain circuit stability. This value should be increased to 10 μ F or more if the battery connection is made any distance from the charger output. If the AAT3670 is to be used in applications where the battery can be removed from the charger, such as with the case with desktop charging cradles, an output capacitor greater than 10 μ F, but less than 20 μ F, may be required to retard the device from cycling on and off when no battery is present.

Printed Circuit Board Layout Considerations

For the best results, it is recommended to physically place the battery pack as close as possible to the AAT3670 BAT pin as possible. To minimize voltage drops on the PCB, keep the high current carrying traces adequately wide. For maximum power dissipation of the AAT3670 QFN package, the metal substrate should be solder bonded to the board. It is also recommended to maximize the substrate contact to the PCB ground plane layer to further increase local heat dissipation. Refer to the AAT3670 evaluation board for a good layout example.

Ordering Information

Package	Marking ¹	Part Number (Tape and Reel) ²
QFN44-24	TFXY	AAT3670ISK-4.2-T1



All AnalogicTech products are offered in Pb-free packaging. The term “Pb-free” means semiconductor products that are in compliance with current RoHS standards, including the requirement that lead not exceed 0.1% by weight in homogeneous materials. For more information, please visit our website at <http://www.analogictech.com/pbfree>.

Package Information³

QFN44-24

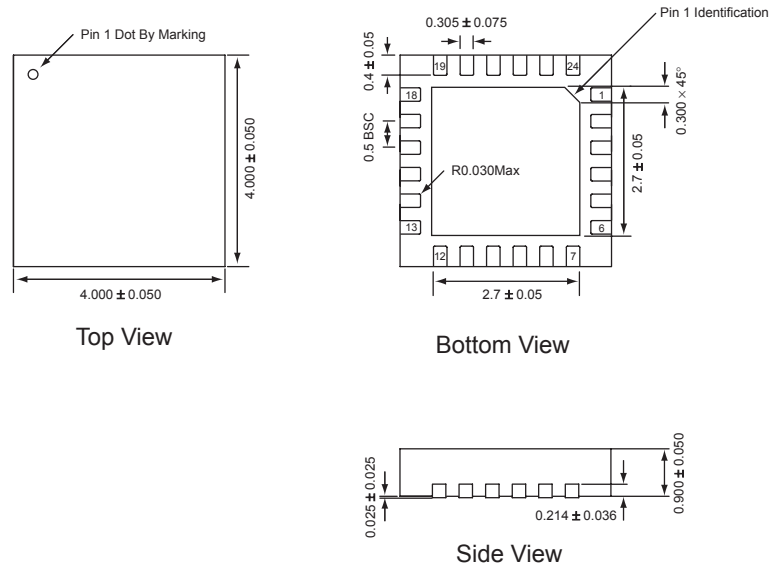

All dimensions in millimeters.

1. XYY = assembly and date code.
2. Sample stock is generally held on part numbers listed in **BOLD**.
3. The leadless package family, which includes QFN, TQFN, DFN, TDFN and STDFN, has exposed copper (unplated) at the end of the lead terminals due to the manufacturing process. A solder fillet at the exposed copper edge cannot be guaranteed and is not required to ensure a proper bottom solder connection.

© Advanced Analogic Technologies, Inc.

AnalogicTech cannot assume responsibility for use of any circuitry other than circuitry entirely embodied in an AnalogicTech product. No circuit patent licenses, copyrights, mask work rights, or other intellectual property rights are implied. AnalogicTech reserves the right to make changes to their products or specifications or to discontinue any product or service without notice. Customers are advised to obtain the latest version of relevant information to verify, before placing orders, that information being relied on is current and complete. All products are sold subject to the terms and conditions of sale supplied at the time of order acknowledgement, including those pertaining to warranty, patent infringement, and limitation of liability. AnalogicTech warrants performance of its semiconductor products to the specifications applicable at the time of sale in accordance with AnalogicTech's standard warranty. Testing and other quality control techniques are utilized to the extent AnalogicTech deems necessary to support this warranty. Specific testing of all parameters of each device is not necessarily performed.

AnalogicTech and the AnalogicTech logo are trademarks of Advanced Analogic Technologies Incorporated. All other brand and product names appearing in this document are registered trademarks or trademarks of their respective holders.

Advanced Analogic Technologies, Inc.
830 E. Arques Avenue, Sunnyvale, CA 94085
Phone (408) 737-4600
Fax (408) 737-4611

