

FS70SMJ-2

HIGH-SPEED SWITCHING USE

FS70SMJ-2



- 4V DRIVE
- V_{DSS} 100V
- $r_{DS(ON)}$ (MAX) 17m Ω
- I_D 70A
- Integrated Fast Recovery Diode (TYP.) 115ns

OUTLINE DRAWING

Dimensions in mm

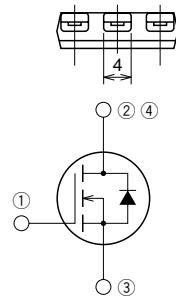
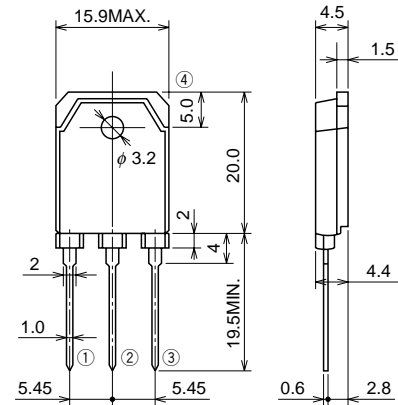

- ① GATE
- ② DRAIN
- ③ SOURCE
- ④ DRAIN

TO-3P

APPLICATION

Motor control, Lamp control, Solenoid control
DC-DC converter, etc.

MAXIMUM RATINGS (T_c = 25°C)

Symbol	Parameter	Conditions	Ratings	Unit
V_{DSS}	Drain-source voltage	$V_{GS} = 0V$	100	V
V_{GSS}	Gate-source voltage	$V_{DS} = 0V$	± 20	V
I_D	Drain current		70	A
I_{DM}	Drain current (Pulsed)		280	A
I_{DA}	Avalanche drain current (Pulsed)	$L = 100\mu H$	70	A
I_S	Source current		70	A
I_{SM}	Source current (Pulsed)		280	A
P_D	Maximum power dissipation		150	W
T_{ch}	Channel temperature		-55 ~ +150	°C
T_{stg}	Storage temperature		-55 ~ +150	°C
—	Weight	Typical value	4.8	g

ELECTRICAL CHARACTERISTICS (Tch = 25°C)

Symbol	Parameter	Test conditions	Limits			Unit
			Min.	Typ.	Max.	
V(BR)DSS	Drain-source breakdown voltage	ID = 1mA, VGS = 0V	100	—	—	V
IGSS	Gate-source leakage current	VGS = ±20V, VDS = 0V	—	—	±0.1	μA
IDSS	Drain-source leakage current	VDS = 100V, VGS = 0V	—	—	0.1	mA
VGS(th)	Gate-source threshold voltage	ID = 1mA, VDS = 10V	1.0	1.5	2.0	V
rDS(ON)	Drain-source on-state resistance	ID = 35A, VGS = 10V	—	13	17	mΩ
rDS(ON)	Drain-source on-state resistance	ID = 35A, VGS = 4V	—	14	18	mΩ
VDS(ON)	Drain-source on-state voltage	ID = 35A, VGS = 10V	—	0.46	0.60	V
yfs	Forward transfer admittance	ID = 35A, VDS = 10V	—	68	—	S
Ciss	Input capacitance	VDS = 10V, VGS = 0V, f = 1MHz	—	8200	—	pF
Coss	Output capacitance		—	1150	—	pF
Crss	Reverse transfer capacitance		—	600	—	pF
td(on)	Turn-on delay time	VDD = 50V, ID = 35A, VGS = 10V, RGEN = RGS = 50Ω	—	54	—	ns
tr	Rise time		—	140	—	ns
td(off)	Turn-off delay time		—	830	—	ns
tf	Fall time		—	350	—	ns
VSD	Source-drain voltage	IS = 35A, VGS = 0V	—	1.0	1.5	V
Rth(ch-c)	Thermal resistance	Channel to case	—	—	0.83	°C/W
trr	Reverse recovery time	IS = 70A, dis/dt = -100A/μs	—	115	—	ns

PERFORMANCE CURVES

POWER DISSIPATION DERATING CURVE

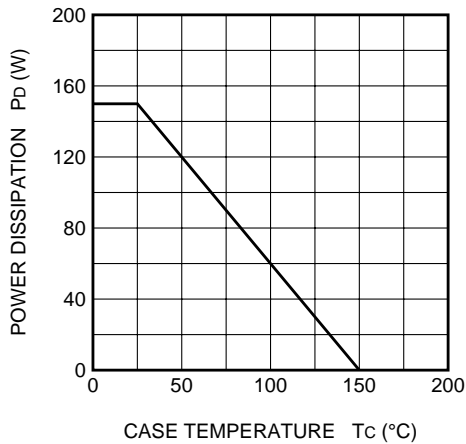

MAXIMUM SAFE OPERATING AREA

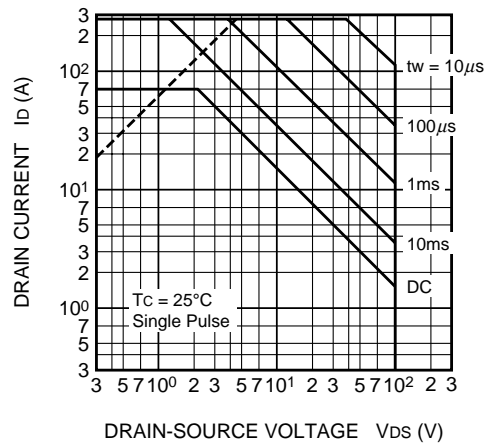

OUTPUT CHARACTERISTICS (TYPICAL)

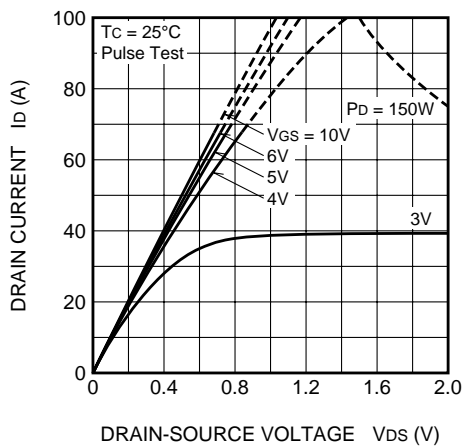

OUTPUT CHARACTERISTICS (TYPICAL)

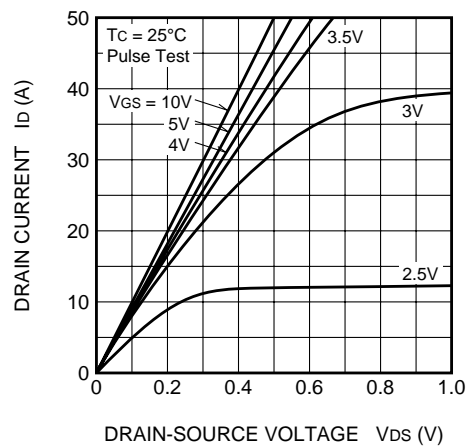

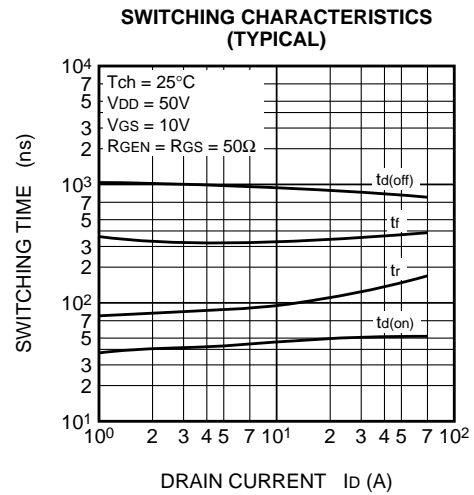
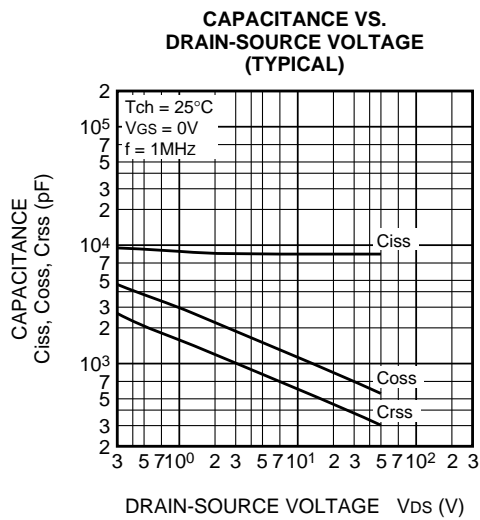
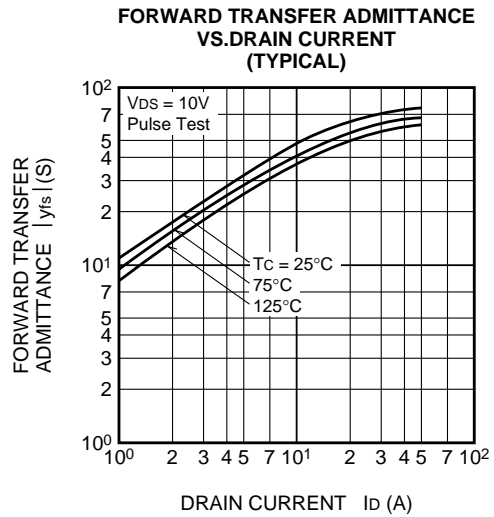
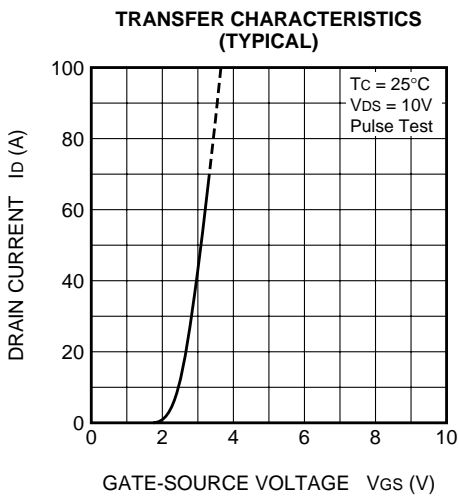
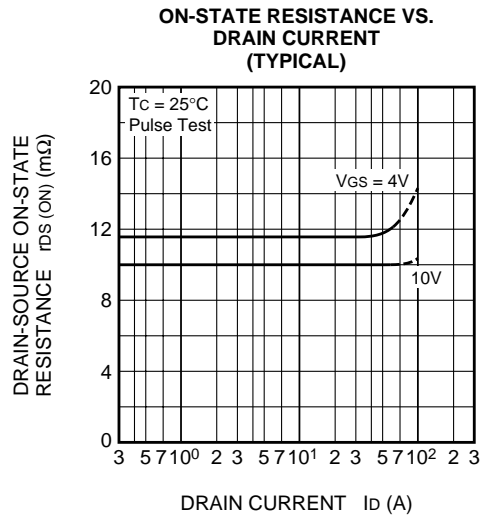
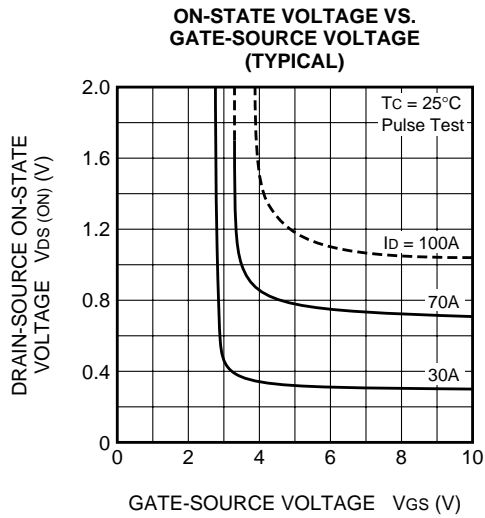

GATE-SOURCE VOLTAGE VS. GATE CHARGE (TYPICAL)

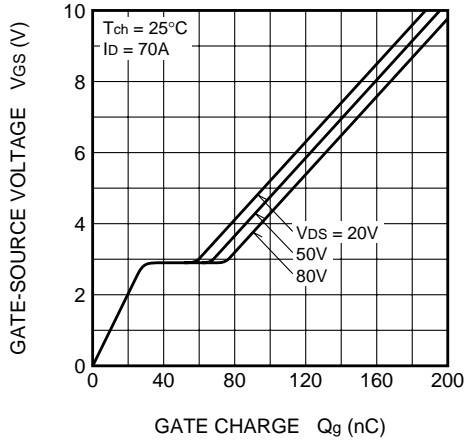

SOURCE-DRAIN DIODE FORWARD CHARACTERISTICS (TYPICAL)

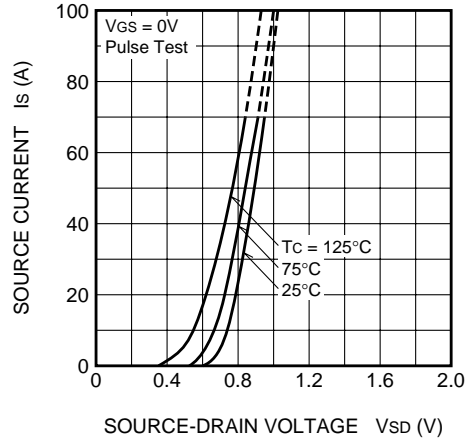

ON-STATE RESISTANCE VS. CHANNEL TEMPERATURE (TYPICAL)

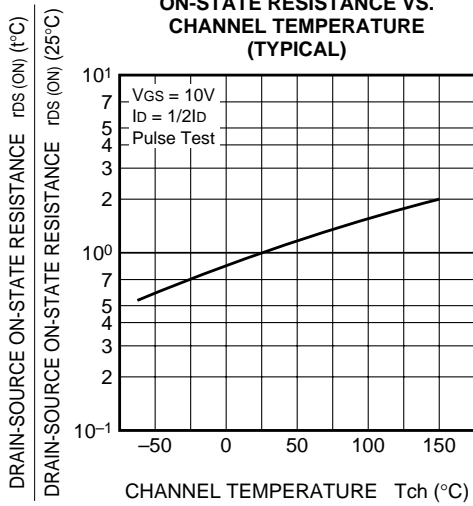

THRESHOLD VOLTAGE VS. CHANNEL TEMPERATURE (TYPICAL)

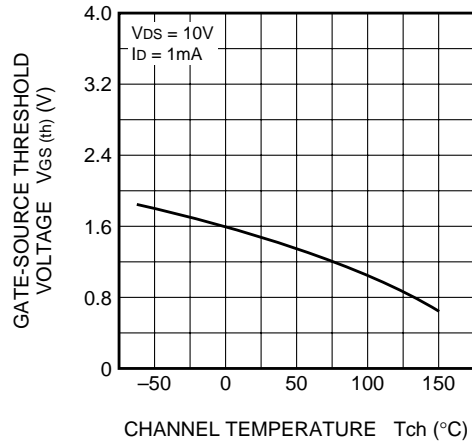

BREAKDOWN VOLTAGE VS. CHANNEL TEMPERATURE (TYPICAL)

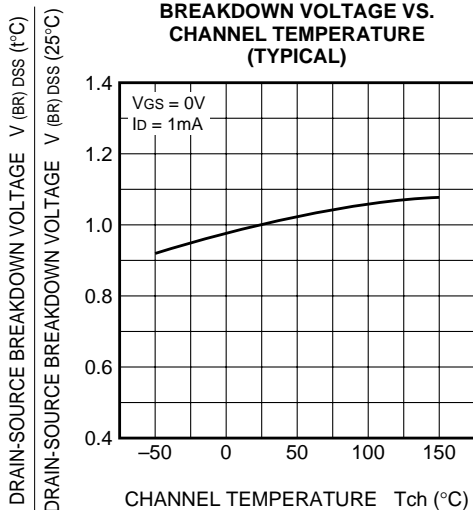

TRANSIENT THERMAL IMPEDANCE CHARACTERISTICS

