

IRG4BC15MDPbF

INSULATED GATE BIPOLAR TRANSISTOR WITH ULTRAFAST
SOFT RECOVERY DIODE

Short Circuit Rated
Fast IGBT

Features

- Rugged: 10μsec short circuit capable at $V_{GS} = 15V$
- Low $V_{CE(on)}$ for 4 to 10kHz applications
- IGBT co-packaged with ultra-soft-recovery anti-parallel diodes
- Industry standard TO-220AB package

Benefits

- Best Value for Appliance and Industrial applications
- Offers highest efficiency and short circuit capability for intermediate applications
- Provides best efficiency for the mid range frequency (4 to 10kHz)
- Optimized for Appliance and Industrial applications up to 1HP
- High noise immune "Positive Only" gate drive - Negative bias gate drive not necessary
- For Low EMI designs - requires little or no snubbing
- Single Package switch for bridge circuit applications
- Compatible with high voltage Gate Drive IC's
- Allows simpler gate drive

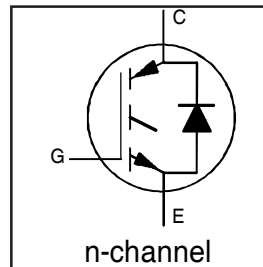

| |
|-----------------------------------|
| $V_{CES} = 600V$ |
| $V_{CE(on)} \text{ typ.} = 1.88V$ |
| @ $V_{GE} = 15V, I_C = 8.6A$ |

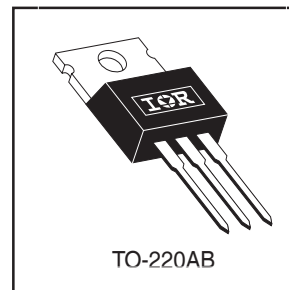

Absolute Maximum Ratings

| | Parameter | Max. | Units |
|---------------------------|---|-----------------------------------|-------|
| V_{CES} | Collector-to-Emitter Voltage | 600 | V |
| $I_C @ T_C = 25^\circ C$ | Continuous Collector Current | 14 | A |
| $I_C @ T_C = 100^\circ C$ | Continuous Collector Current | 8.6 | |
| I_{CM} | Pulsed Collector Current ① | 28 | |
| I_{LM} | Clamped Inductive Load Current ② | 28 | |
| $I_F @ T_C = 100^\circ C$ | Diode Continuous Forward Current | 4.0 | |
| t_{sc} | Short Circuit Withstand Time | 12 | μs |
| I_{FM} | Diode Maximum Forward Current | 16 | A |
| V_{GE} | Gate-to-Emitter Voltage | ± 20 | V |
| $P_D @ T_C = 25^\circ C$ | Maximum Power Dissipation | 49 | W |
| $P_D @ T_C = 100^\circ C$ | Maximum Power Dissipation | 19 | |
| T_J T_{STG} | Operating Junction and Storage Temperature Range | -55 to +150 | °C |
| | Soldering Temperature, for 10 sec. | 300 (0.063 in. (1.6mm) from case) | |
| | Mounting Torque, 6-32 or M3 Screw. | 10 lbf•in (1.1 N•m) | |

Thermal Resistance

| | Parameter | Min. | Typ. | Max. | Units |
|-----------------|---|------|----------|------|--------|
| $R_{\theta JC}$ | Junction-to-Case - IGBT | — | — | 2.7 | °C/W |
| $R_{\theta JC}$ | Junction-to-Case - Diode | — | — | 7.0 | |
| $R_{\theta CS}$ | Case-to-Sink, flat, greased surface | — | 0.50 | — | |
| $R_{\theta JA}$ | Junction-to-Ambient, typical socket mount | — | — | 80 | |
| Wt | Weight | — | 2 (0.07) | — | g (oz) |

IRG4BC15MDPbF

International
 Rectifier

Electrical Characteristics @ T_J = 25°C (unless otherwise specified)

| | Parameter | Min. | Typ. | Max. | Units | Conditions |
|--|---|------|------|------|-------|--|
| V _{(BR)CES} | Collector-to-Emitter Breakdown Voltage ^③ | 600 | — | — | V | V _{GE} = 0V, I _C = 250μA |
| ΔV _{(BR)CES} /ΔT _J | Temperature Coeff. of Breakdown Voltage | — | 0.65 | — | V/°C | V _{GE} = 0V, I _C = 1.0mA |
| V _{CE(on)} | Collector-to-Emitter Saturation Voltage | — | 1.88 | 2.3 | V | I _C = 8.6A |
| | | — | 2.6 | — | | I _C = 14A |
| | | — | 2.1 | — | | I _C = 8.6A, T _J = 150°C |
| V _{GE(th)} | Gate Threshold Voltage | 4.0 | — | 6.5 | | V _{CE} = V _{GE} , I _C = 250μA |
| ΔV _{GE(th)} /ΔT _J | Temperature Coeff. of Threshold Voltage | — | -10 | — | mV/°C | V _{CE} = V _{GE} , I _C = 250μA |
| g _{fe} | Forward Transconductance ^④ | 2.3 | 3.4 | — | S | V _{CE} = 100V, I _C = 6.5A |
| I _{CES} | Zero Gate Voltage Collector Current | — | — | 250 | μA | V _{GE} = 0V, V _{CE} = 600V |
| | | — | — | 1400 | | V _{GE} = 0V, V _{CE} = 600V, T _J = 150°C |
| V _{FM} | Diode Forward Voltage Drop | — | 1.5 | 1.8 | V | I _C = 4.0A |
| | | — | 1.4 | 1.7 | | I _C = 4.0A, T _J = 150°C |
| I _{GES} | Gate-to-Emitter Leakage Current | — | — | ±100 | nA | V _{GE} = ±20V |

Switching Characteristics @ T_J = 25°C (unless otherwise specified)

| | Parameter | Min. | Typ. | Max. | Units | Conditions |
|--------------------------|---|------|------|------|-------|---|
| Q _g | Total Gate Charge (turn-on) | — | 46 | — | nC | I _C = 8.6A |
| Q _{ge} | Gate - Emitter Charge (turn-on) | — | 4.2 | — | | V _{CC} = 400V |
| Q _{gc} | Gate - Collector Charge (turn-on) | — | 15 | — | | V _{GE} = 15V |
| t _{d(on)} | Turn-On Delay Time | — | 21 | — | ns | T _J = 25°C |
| t _r | Rise Time | — | 38 | — | | I _C = 8.6A, V _{CC} = 480V |
| t _{d(off)} | Turn-Off Delay Time | — | 540 | 810 | | V _{GE} = 15V, R _G = 75Ω |
| t _f | Fall Time | — | 350 | 530 | | Energy losses include "tail" and diode reverse recovery. |
| E _{on} | Turn-On Switching Loss | — | 0.32 | — | mJ | T _J = 150°C, I _C = 8.6A, V _{CC} = 480V V _{GE} = 15V, R _G = 75Ω Energy losses include "tail" and diode reverse recovery. |
| E _{off} | Turn-Off Switching Loss | — | 1.93 | — | | |
| E _{ts} | Total Switching Loss | — | 2.25 | 3.6 | | |
| t _{d(on)} | Turn-On Delay Time | — | 20 | — | ns | T _J = 150°C, I _C = 8.6A, V _{CC} = 480V V _{GE} = 15V, R _G = 75Ω Energy losses include "tail" and diode reverse recovery. |
| t _r | Rise Time | — | 42 | — | | |
| t _{d(off)} | Turn-Off Delay Time | — | 650 | — | | |
| t _f | Fall Time | — | 590 | — | | |
| E _{ts} | Total Switching Loss | — | 3.0 | — | mJ | |
| L _E | Internal Emitter Inductance | — | 7.5 | — | nH | Measured 5mm from package |
| C _{ies} | Input Capacitance | — | 340 | — | pF | V _{GE} = 0V V _{CC} = 30V f = 1.0MHz |
| C _{oes} | Output Capacitance | — | 35 | — | | |
| C _{res} | Reverse Transfer Capacitance | — | 8.8 | — | | |
| t _{rr} | Diode Reverse Recovery Time | — | 28 | 42 | ns | T _J = 25°C |
| | | — | 38 | 57 | | T _J = 125°C |
| I _{rr} | Diode Peak Reverse Recovery Current | — | 2.9 | 5.2 | A | T _J = 25°C |
| | | — | 3.7 | 6.7 | | T _J = 125°C |
| Q _{rr} | Diode Reverse Recovery Charge | — | 40 | 60 | nC | T _J = 25°C |
| | | — | 70 | 110 | | T _J = 125°C |
| di _(rec) M/dt | Diode Peak Rate of Fall of Recovery During t _b | — | 280 | — | A/μs | T _J = 25°C |
| | | — | 240 | — | | T _J = 125°C |

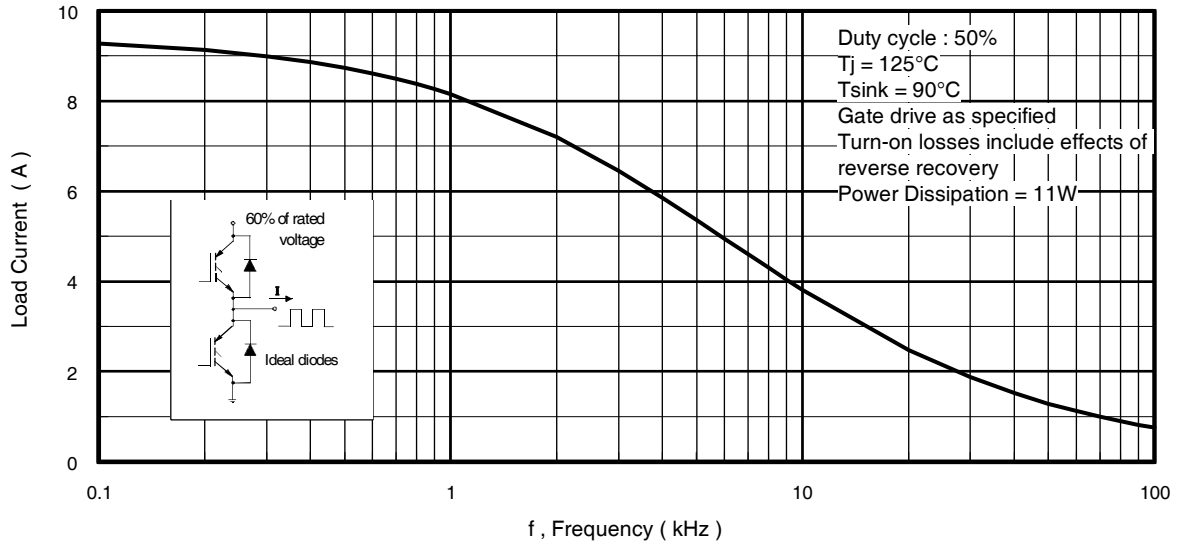

Fig. 1 - Typical Load Current vs. Frequency
 (Load Current = I_{RMS} of fundamental)

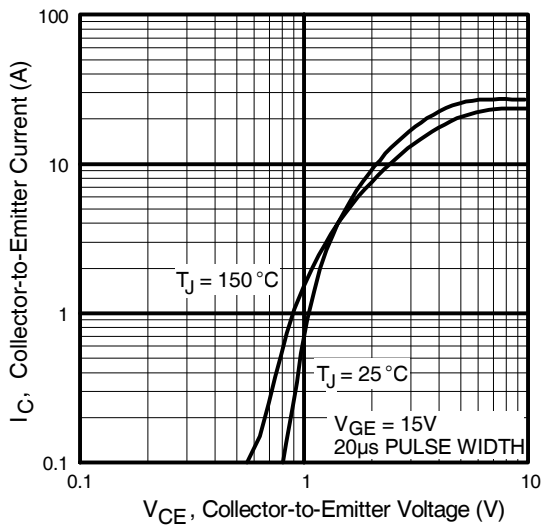

Fig. 2 - Typical Output Characteristics

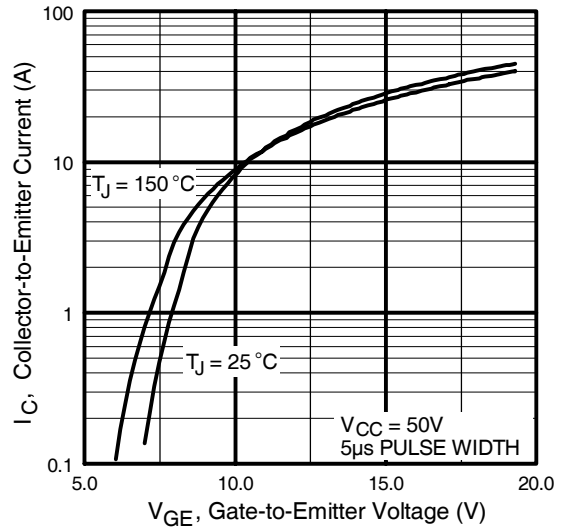

Fig. 3 - Typical Transfer Characteristics

IRG4BC15MDPbF

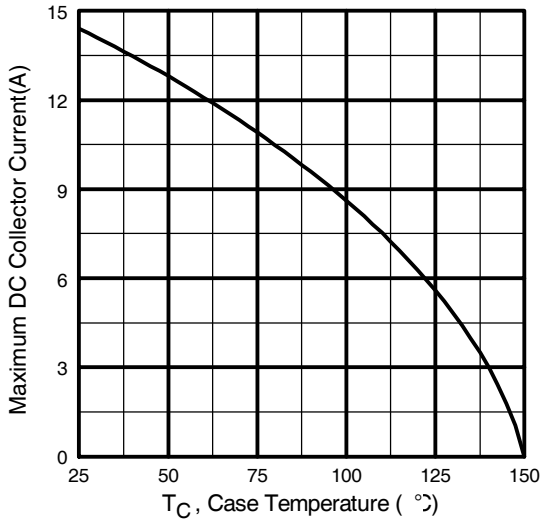

Fig. 4 - Maximum Collector Current vs. Case Temperature

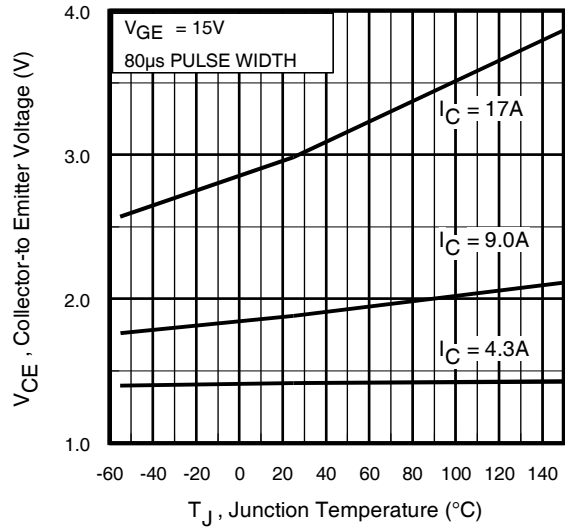

Fig. 5 - Typical Collector-to-Emitter Voltage vs. Junction Temperature

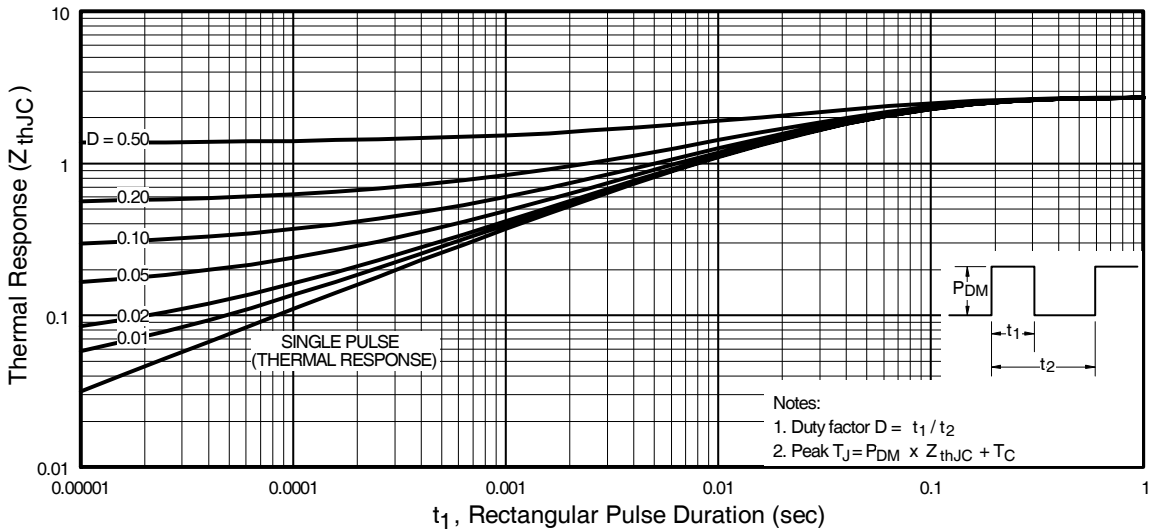

Fig. 6 - Maximum Effective Transient Thermal Impedance, Junction-to-Case

IRG4BC15MDPbF

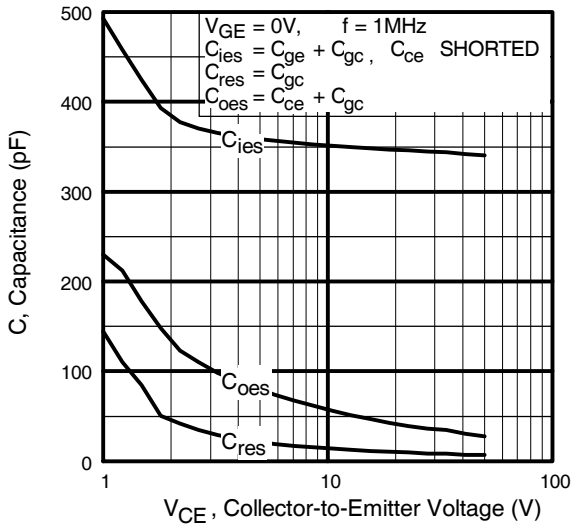

Fig. 7 - Typical Capacitance vs. Collector-to-Emitter Voltage

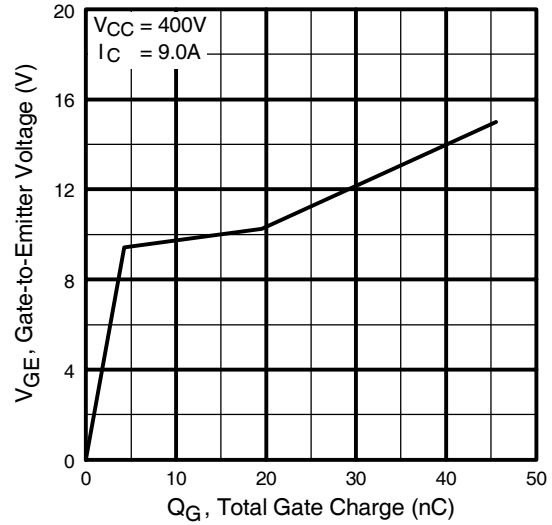

Fig. 8 - Typical Gate Charge vs. Gate-to-Emitter Voltage

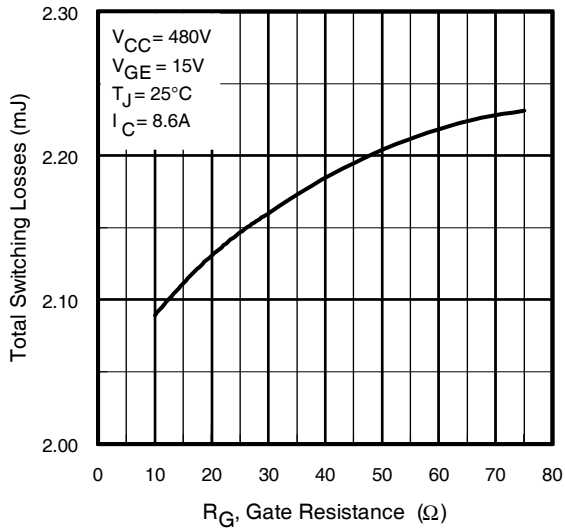

Fig. 9 - Typical Switching Losses vs. Gate Resistance

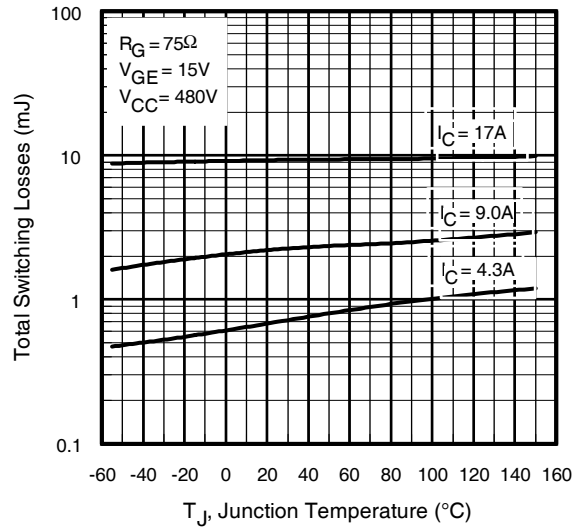

Fig. 10 - Typical Switching Losses vs. Junction Temperature

IRG4BC15MDPbF

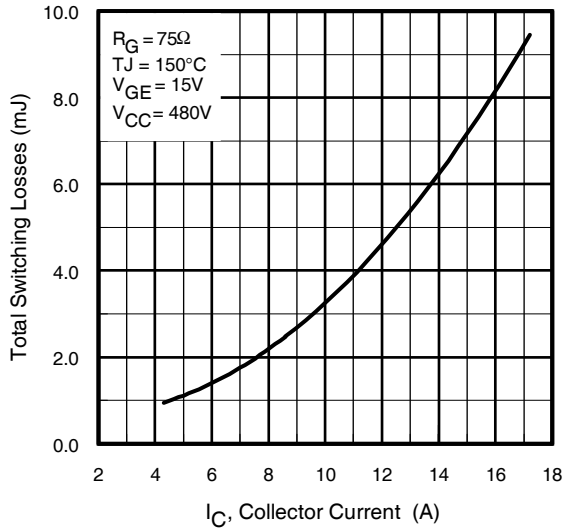

Fig. 11 - Typical Switching Losses vs. Collector-to-Emitter Current

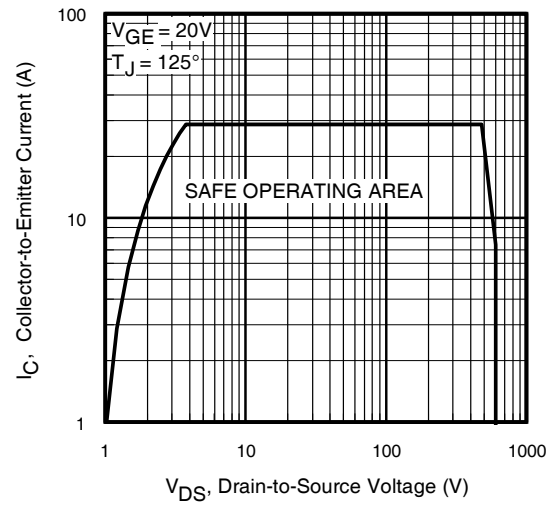
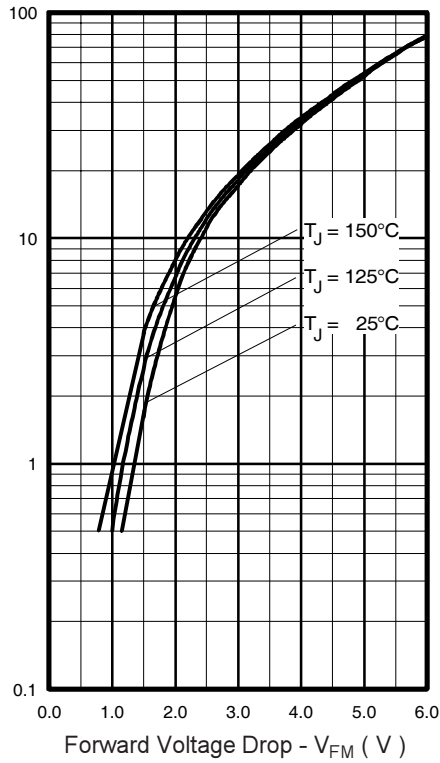

Fig. 12 - Turn-Off SOA



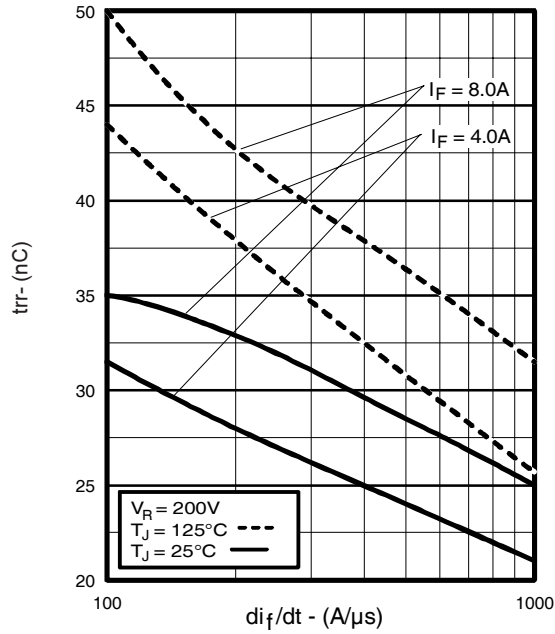

Fig. 14 - Typical Reverse Recovery vs. di_f/dt

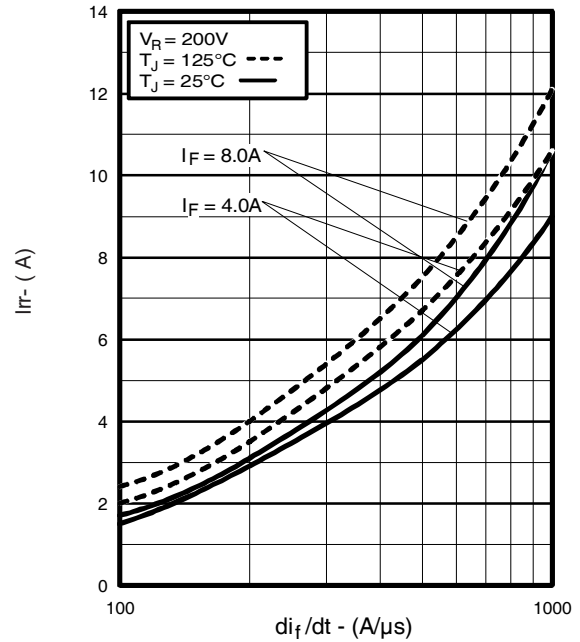

Fig. 15 - Typical Recovery Current vs. di_f/dt

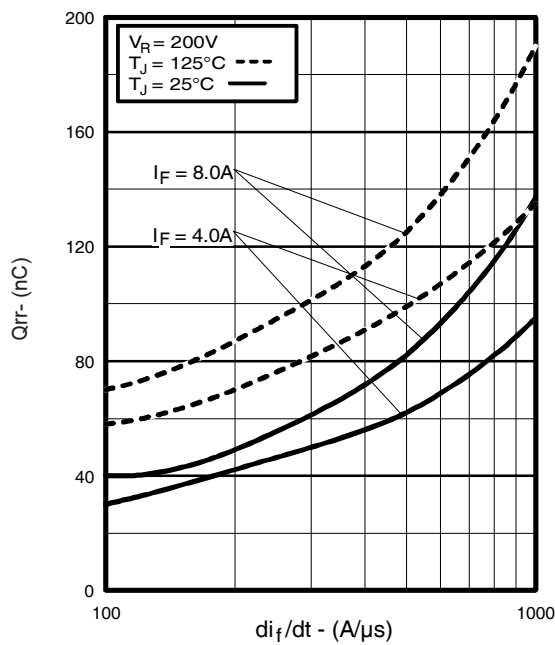

Fig. 16 - Typical Stored Charge vs. di_f/dt

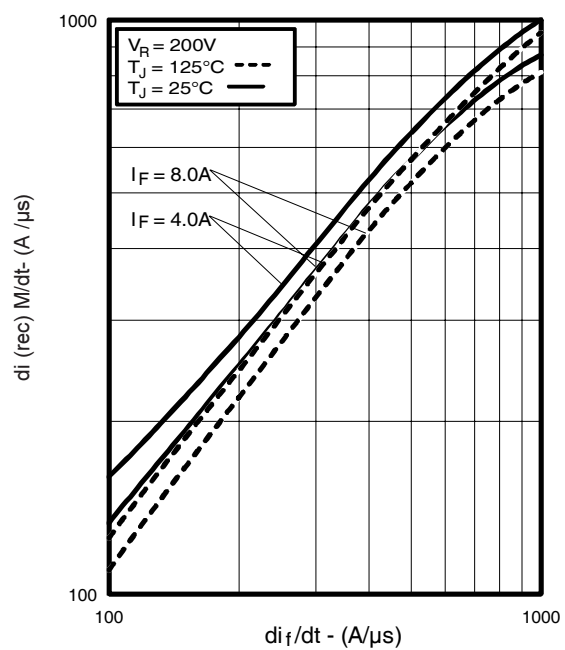

Fig. 17 - Typical $di_{(rec)M}/dt$ vs. di_f/dt ,

IRG4BC15MDPbF

International
IR Rectifier

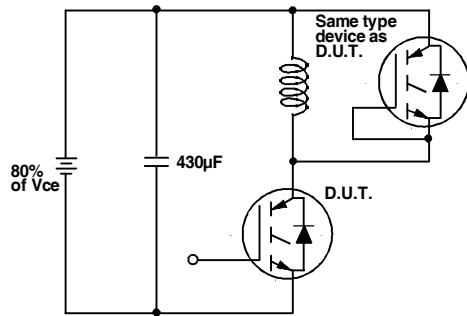

Fig. 18a - Test Circuit for Measurement of I_{LM} , E_{on} , $E_{off}(\text{diode})$, t_{rr} , Q_{rr} , I_{rr} , $t_{d(on)}$, t_r , $t_{d(off)}$, t_f

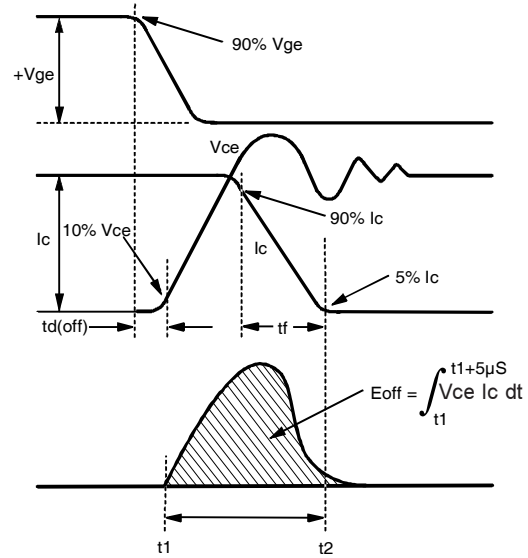

Fig. 18b - Test Waveforms for Circuit of Fig. 18a, Defining E_{off} , $t_{d(off)}$, t_f

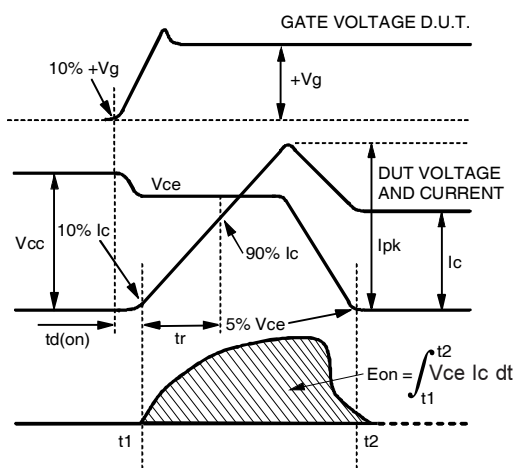

Fig. 18c - Test Waveforms for Circuit of Fig. 18a, Defining E_{on} , $t_{d(on)}$, t_r

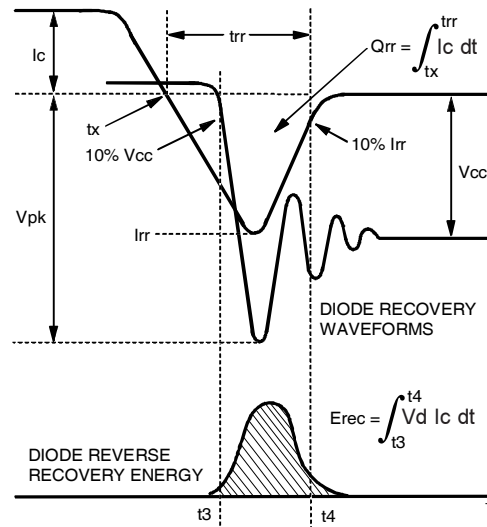

Fig. 18d - Test Waveforms for Circuit of Fig. 18a, Defining E_{rec} , t_{rr} , Q_{rr} , I_{rr}

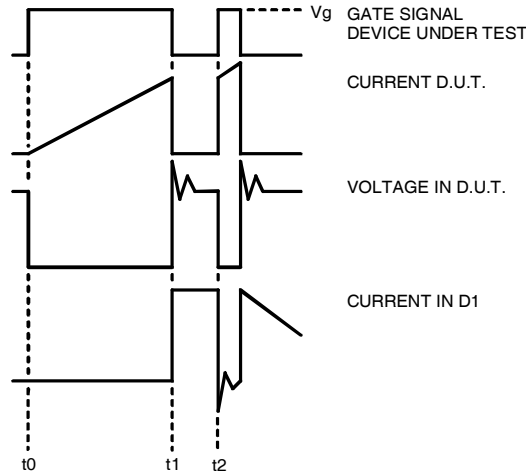

Figure 18e. Macro Waveforms for Figure 18a's Test Circuit

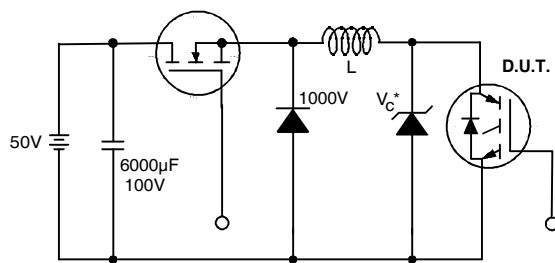

Figure 19. Clamped Inductive Load Test Circuit

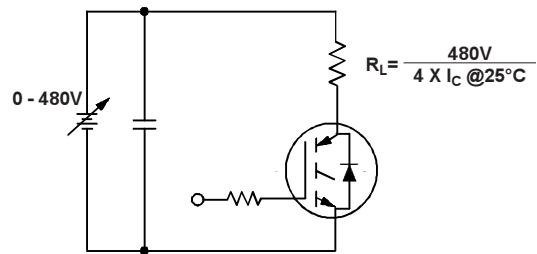

Figure 20. Pulsed Collector Current Test Circuit

IRG4BC15MDPbF



Notes:

- ① Repetitive rating: $V_{GE}=20V$; pulse width limited by maximum junction temperature
- ② $V_{CC}=80\%(V_{CES})$, $V_{GE}=20V$, $L=10\mu H$, $R_G = 75\Omega$
- ③ Pulse width $\leq 80\mu s$; duty factor $\leq 0.1\%$.
- ④ Pulse width $5.0\mu s$, single shot.

TO-220AB Package Outline

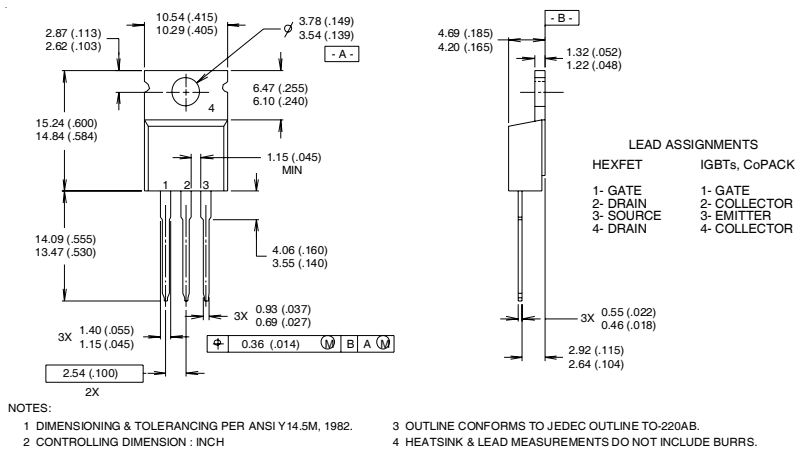

TO-220AB Part Marking Information

EXAMPLE: THIS IS AN IRF1010
 LOT CODE 1789
 ASSEMBLED ON WW 19, 1997
 IN THE ASSEMBLY LINE "C"
Note: "P" in assembly line
 position indicates "Lead-Free"

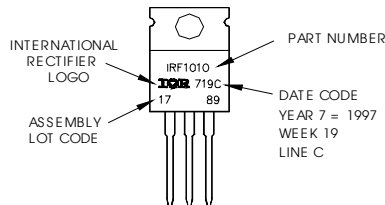

Data and specifications subject to change without notice.
 This product has been designed and qualified for the industrial market.
 Qualification Standards can be found on IR's Web site.



IR WORLD HEADQUARTERS: 233 Kansas St., El Segundo, California 90245, USA Tel: (310) 252-7105
 TAC Fax: (310) 252-7903
 Visit us at www.irf.com for sales contact information.08/04