

NPN SILICON EPITAXIAL TRANSISTOR
FOR L-BAND LOW-POWER AMPLIFIER

The 2SC5289 is ideal for the final stage amplifier in 1.9G Hz-band digital cordless phones (DECT, PHS, etc.).

FEATURES

- $P_{-1} = 27$ dBm TYP.
@f = 1.9 GHz, $V_{CC} = 3.6$ V, $I_{CQ} = 1$ mA (Class AB), Duty = 1/8
- 4-Pin Mini Mold Package
EIAJ: SC-61

ORDERING INFORMATION

Part Number	Quantity	Packing Style
2SC5289-T1	3 Kpcs/Reel	Embossed tape 8 mm wide. Pin 3 (Base), Pin 4 (Emitter) face to perforation side of the tape.

Remark If you require an evaluation sample, please contact an NEC Sales Representative. (Unit sample quantity is 50 pcs.)

ABSOLUTE MAXIMUM RATINGS ($T_A = 25$ °C)

Parameter	Symbol	Rating	Unit
Collector to Base Voltage	V_{CBO}	9.0	V
Collector to Emitter Voltage	V_{CEO}	6.0	V
Emitter to Base Voltage	V_{EBO}	2.0	V
Collector Current	I_C	300	mA
Total Power Dissipation	P_T	200 (CW)	mW
		1.2 (duty = 1/8) ^{Note}	W
		3.0 (duty = 1/24) ^{Note}	W
Junction Temperature	T_j	150	°C
Storage Temperature	T_{stg}	-65 to +150	°C

Note Pulse period is 10 msec or less.

PACKAGE DRAWING

(Unit: mm)

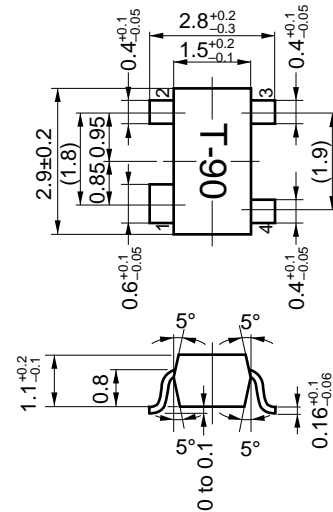

PIN CONNECTIONS

1. Collector
2. Emitter
3. Base
4. Emitter

ELECTRICAL CHARACTERISTICS (T_A = 25 °C)

Parameter	Symbol	Condition	MIN.	TYP.	MAX.	Unit
Collector Cutoff Current	I _{CB0}	V _{CB} = 5 V, I _E = 0			5	μA
Emitter Cutoff Current	I _{EB0}	V _{EB} = 1 V, I _C = 0			5	μA
DC Current Gain	h _{FE}	V _{CE} = 3.6 V, I _C = 200 mA	60			
Output Power	P ₋₁	V _{CC} = 3.6 V, f = 1.9 GHz,	26.3	27.0		dBm
Power Gain	G _P	I _{CQ} = 1 mA (class AB operation)	5.0	6.0		dB
Collector Efficiency	η _C	Duty factor 1/8	60	70		%

h_{FE} Classification

Rank	FB
Marking	T90
h _{FE}	more than 60

APPLICATION EXAMPLES

(1) Power amplifier for DECT

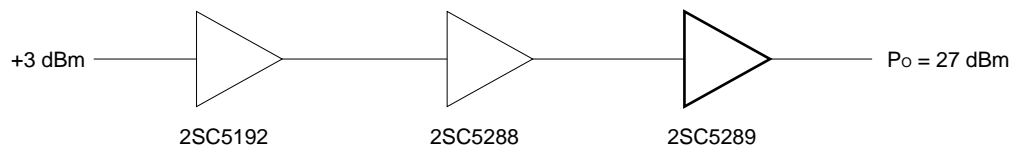

(2) Power amplifier for PHS

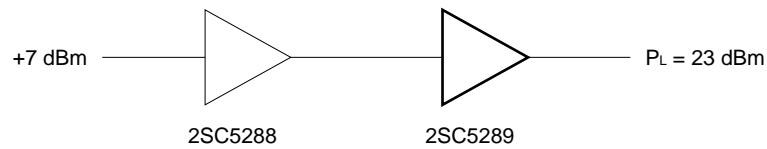

TYPICAL CHARACTERISTICS (T_A = 25 °C)

COLLECTOR CURRENT vs. BASE TO EMITTER VOLTAGE

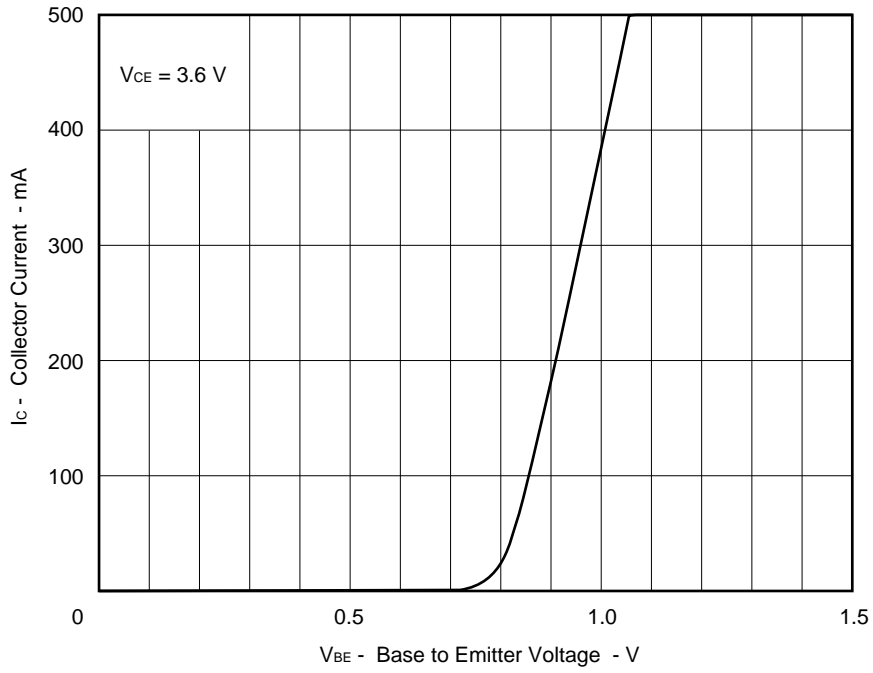

COLLECTOR CURRENT vs. COLLECTOR TO EMITTER VOLTAGE

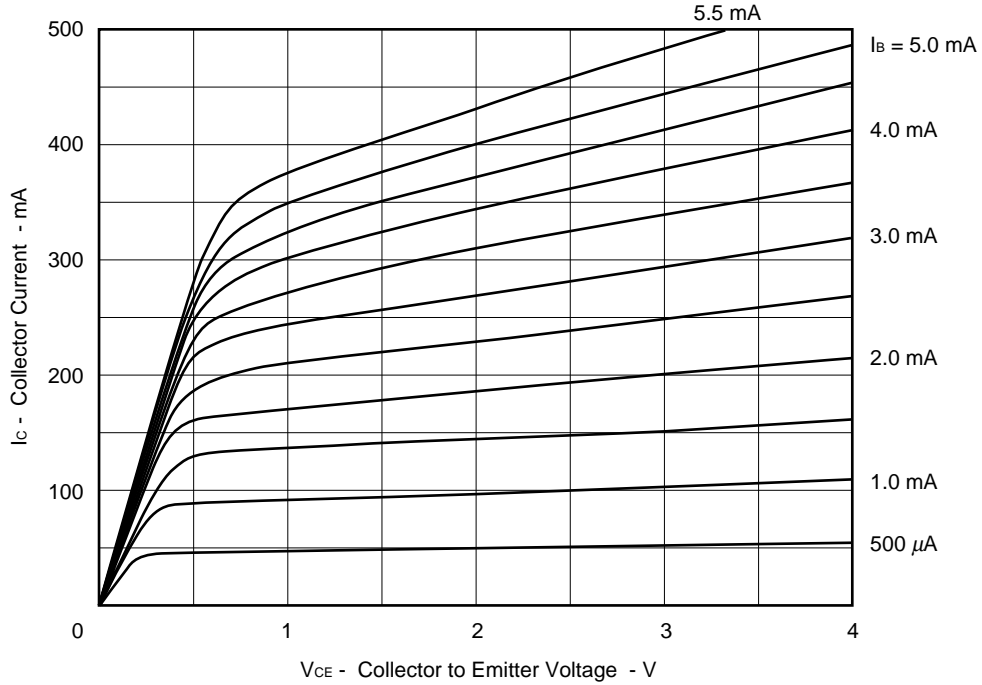

S-Parameters

(V_{CE} = 3.0 V, I_c = 60 mA)

FREQUENCY MHz	S11		S21		S12		S22	
	MAG.	ANG.	MAG.	ANG.	MAG.	ANG.	MAG.	ANG.
1 500.000 000	810.84 mU	138.58	1.9411 U	48.639	106.35 mU	46.46	583.53 mU	159.88
1 600.000 000	813.96 mU	133.87	1.8066 U	45.93	110.68 mU	44.993	590.28 mU	158.28
1 700.000 000	816.5 mU	131.39	1.6922 U	43.227	116.71 mU	43.52	592.75 mU	156.45
1 800.000 000	820.32 mU	128.91	1.5947 U	40.814	121.32 mU	42.529	598.22 mU	154.73
1 900.000 000	823.53 mU	126.37	1.5047 U	38.489	126.6 mU	41.046	601.49 mU	153.51
2 000.000 000	826 mU	124.27	1.4214 U	35.858	132.01 mU	39.913	606.01 mU	151.61
2 100.000 000	832.11 mU	122.04	1.3543 U	33.591	135.99 mU	38.572	611.23 mU	150.13
2 200.000 000	832.82 mU	119.84	1.2811 U	31.268	140.46 mU	37.029	618.61 mU	148.64
2 300.000 000	835.22 mU	117.85	1.2145 U	28.982	143.87 mU	35.675	623.46 mU	147.37
2 400.000 000	839.52 mU	115.84	1.1656 U	26.992	147.44 mU	34.898	629 mU	146.29
2 500.000 000	840.38 mU	113.83	1.1211 U	25.076	152.24 mU	33.256	632.59 mU	144.88

(V_{CE} = 3.0 V, I_c = 80 mA)

FREQUENCY MHz	S11		S21		S12		S22	
	MAG.	ANG.	MAG.	ANG.	MAG.	ANG.	MAG.	ANG.
1 500.000 000	813.12 mU	136.29	1.9451 U	49.022	106.65 mU	47.457	603.6 mU	159.07
1 600.000 000	816.14 mU	133.57	1.8087 U	46.342	112.69 mU	45.889	605.91 mU	157.35
1 700.000 000	818.21 mU	131.14	1.6967 U	43.58	118.33 mU	44.529	609.17 mU	156.06
1 800.000 000	822.23 mU	128.59	1.5995 U	41.298	123.28 mU	43.227	615.78 mU	154.14
1 900.000 000	825.38 mU	126.15	1.5075 U	38.838	128.06 mU	42.023	619.82 mU	152.61
2 000.000 000	829.15 mU	124	1.4232 U	36.546	133.55 mU	40.346	623.76 mU	151.12
2 100.000 000	832.63 mU	121.76	1.3533 U	34.178	137.17 mU	39.234	630.54 mU	149.1
2 200.000 000	834.44 mU	119.51	1.2662 U	31.984	141.07 mU	37.601	634.29 mU	147.64
2 300.000 000	836.5 mU	117.57	1.2165 U	29.798	146.25 mU	36.573	636.78 mU	146.34
2 400.000 000	839.25 mU	115.54	1.1706 U	27.681	148.91 mU	35.034	644.03 mU	145.35
2 500.000 000	842.51 mU	113.57	1.127 U	25.898	153.45 mU	33.795	645.68 mU	144.07

(V_{CE} = 3.0 V, I_c = 100 mA)

FREQUENCY MHz	S11		S21		S12		S22	
	MAG.	ANG.	MAG.	ANG.	MAG.	ANG.	MAG.	ANG.
1 500.000 000	814.76 mU	136.05	1.9314 U	49.065	107.99 mU	48.52	613.88 mU	158.57
1 600.000 000	819.31 mU	133.37	1.7962 U	46.439	113.83 mU	46.594	617.68 mU	156.93
1 700.000 000	820.45 mU	130.97	1.6833 U	43.752	119.44 mU	45.216	620.63 mU	155.09
1 800.000 000	823.79 mU	128.45	1.5864 U	41.582	123.31 mU	44.018	624.8 mU	153.83
1 900.000 000	827.67 mU	125.99	1.4947 U	38.993	128.74 mU	42.175	626.73 mU	151.85
2 000.000 000	830.69 mU	123.79	1.4116 U	36.707	134.1 mU	40.887	631.19 mU	150.46
2 100.000 000	834.12 mU	121.57	1.3432 U	34.319	138.16 mU	39.995	642.25 mU	148.78
2 200.000 000	836.05 mU	119.32	1.2755 U	32.113	142.04 mU	37.886	544.41 mU	147.45
2 300.000 000	838.39 mU	117.41	1.2099 U	30.096	146.83 mU	36.992	546.33 mU	145.95
2 400.000 000	841.47 mU	115.41	1.1664 U	27.746	150.91 mU	35.305	653.15 mU	144.75
2 500.000 000	842.96 mU	113.41	1.1146 U	26.175	154.92 mU	33.58	655.82 mU	143.5

(V_{CE} = 3.0 V, I_c = 120 mA)

FREQUENCY MHz	S11		S21		S12		S22	
	MAG.	ANG.	MAG.	ANG.	MAG.	ANG.	MAG.	ANG.
1 500.000 000	817.28 mU	135.92	1.9053 U	49.017	108.15 mU	48.654	619.53 mU	158.16
1 600.000 000	820.4 mU	133.2	1.772 U	46.493	114.57 mU	46.991	621.8 mU	156.39
1 700.000 000	823.36 mU	130.75	1.6595 U	43.726	120.09 mU	45.655	626.29 mU	154.92
1 800.000 000	825.32 mU	128.24	1.5695 U	41.45	124.51 mU	44.155	630.47 mU	153.42
1 900.000 000	829.2 mU	125.81	1.4774 U	39.018	129.92 mU	42.933	635.85 mU	151.35
2 000.000 000	832.76 mU	123.66	1.394 U	36.696	135.38 mU	40.954	638.73 mU	150.05
2 100.000 000	836.5 mU	121.44	1.3251 U	34.448	139.38 mU	38.463	647.33 mU	148.43
2 200.000 000	837.77 mU	119.19	1.2596 U	32.257	143.42 mU	38.091	649.58 mU	147
2 300.000 000	839.95 mU	117.27	1.1933 U	30.067	147.59 mU	36.9	655.77 mU	145.6
2 400.000 000	843.73 mU	115.36	1.1516 U	27.979	151.38 mU	35.674	657.89 mU	144.41
2 500.000 000	845.73 mU	113.3	1.1061 U	25.164	155.57 mU	33.967	661.28 mU	143.06

(V_{CE} = 3.6 V, I_c = 60 mA)

FREQUENCY MHz	S11		S21		S12		S22	
	MAG.	ANG.	MAG.	ANG.	MAG.	ANG.	MAG.	ANG.
1 500.000 000	808.3 mU	136.65	1.9727 U	48.44	105.45 mU	46.052	581.18 mU	159.62
1 600.000 000	812.04 mU	133.93	1.8331 U	45.887	112.14 mU	44.817	583.78 mU	157.84
1 700.000 000	814.93 mU	131.51	1.717 U	43.075	116.65 mU	43.513	590.19 mU	156.29
1 800.000 000	818.28 mU	128.96	1.6198 U	40.627	121.29 mU	42.255	593.64 mU	154.41
1 900.000 000	821.86 mU	126.44	1.5247 U	38.187	126.81 mU	40.746	595.96 mU	153.05
2 000.000 000	825.72 mU	124.19	1.4443 U	35.744	131.1 mU	39.637	600.82 mU	151.54
2 100.000 000	829.72 mU	122.08	1.3633 U	33.442	135.38 mU	37.827	607.63 mU	149.72
2 200.000 000	831.5 mU	119.79	1.3006 U	31.143	139.8 mU	36.841	611.6 mU	148.28
2 300.000 000	833.66 mU	117.82	1.2319 U	28.858	143.3 mU	35.421	616.97 mU	146.8
2 400.000 000	836.78 mU	115.85	1.1841 U	26.723	148.34 mU	33.849	621.4 mU	145.82
2 500.000 000	839.53 mU	113.76	1.1409 U	24.857	152.76 mU	32.978	626.63 mU	144.7

(V_{CE} = 3.6 V, I_c = 80 mA)

FREQUENCY MHz	S11		S21		S12		S22	
	MAG.	ANG.	MAG.	ANG.	MAG.	ANG.	MAG.	ANG.
1 500.000 000	810.02 mU	136.4	1.9728 U	48.837	105.15 mU	47.085	593.74 mU	158.81
1 600.000 000	812.97 mU	133.62	1.8375 U	46.192	113.25 mU	45.405	600.04 mU	157.07
1 700.000 000	816.71 mU	131.18	1.7238 U	43.597	117.53 mU	44.256	603.01 mU	155.32
1 800.000 000	819.83 mU	128.68	1.5254 U	41.101	123.16 mU	42.965	610.67 mU	153.74
1 900.000 000	823.48 mU	126.14	1.5286 U	38.741	127.71 mU	41.206	613.44 mU	152.03
2 000.000 000	825.71 mU	123.85	1.4464 U	36.372	133.19 mU	40.31	616.32 mU	150.5
2 100.000 000	830.91 mU	121.82	1.3721 U	33.966	136.97 mU	38.649	625.55 mU	148.79
2 200.000 000	831.7 mU	119.52	1.3042 U	31.579	141.48 mU	37.348	626.62 mU	147.4
2 300.000 000	833.9 mU	117.61	1.2261 U	29.511	145.67 mU	35.89	632.27 mU	145.74
2 400.000 000	837.44 mU	115.59	1.1905 U	27.144	149.19 mU	34.415	638.49 mU	144.59
2 500.000 000	839.42 mU	113.49	1.1422 U	25.406	153.36 mU	33.499	639.69 mU	143.59

(V_{CE} = 3.6 V, I_c = 100 mA)

FREQUENCY MHz	S11		S21		S12		S22	
	MAG.	ANG.	MAG.	ANG.	MAG.	ANG.	MAG.	ANG.
1 500.000 000	811.66 mU	136.12	1.9697 U	49.003	107.38 mU	47.804	605.34 mU	158.29
1 600.000 000	814.26 mU	133.43	1.8813 U	46.439	113.38 mU	46.29	610.91 mU	156.55
1 700.000 000	818.45 mU	131.04	1.7121 U	43.815	119.26 mU	44.804	615.04 mU	155.21
1 800.000 000	820.54 mU	128.48	1.6163 U	41.259	123.58 mU	43.22	619.69 mU	153.57
1 900.000 000	824.22 mU	126.03	1.5227 U	38.087	129.16 mU	42.119	623.96 mU	151.68
2 000.000 000	828.13 mU	123.78	1.4383 U	36.568	133.74 mU	40.513	626.33 mU	150.24
2 100.000 000	831.24 mU	121.67	1.3657 U	34.401	137.58 mU	39.212	635.21 mU	148.57
2 200.000 000	833.15 mU	119.38	1.2999 U	32.191	142.12 mU	37.807	635.78 mU	147.17
2 300.000 000	835.39 mU	117.42	1.232 U	29.872	146.24 mU	36.259	640.55 mU	145.67
2 400.000 000	838.01 mU	115.39	1.1855 U	27.857	150.55 mU	34.921	644.12 mU	144.38
2 500.000 000	841.32 mU	113.33	1.1384 U	25.845	154.24 mU	33.691	651.67 mU	143.26

(V_{CE} = 3.6 V, I_c = 120 mA)

FREQUENCY MHz	S11		S21		S12		S22	
	MAG.	ANG.	MAG.	ANG.	MAG.	ANG.	MAG.	ANG.
1 500.000 000	813.57 mU	135.96	1.9455 U	48.984	108.18 mU	48.385	614.69 mU	158.01
1 600.000 000	816.62 mU	133.29	1.8105 U	46.497	113.89 mU	47.178	616.3 mU	156.31
1 700.000 000	818.87 mU	130.77	1.6937 U	43.778	119.24 mU	45.229	620.14 mU	154.6
1 800.000 000	822.29 mU	128.31	1.5976 U	41.362	124.45 mU	44.199	624.25 mU	153.27
1 900.000 000	826.68 mU	125.87	1.5032 U	39.125	128.74 mU	42.33	628.44 mU	151.55
2 000.000 000	829.06 mU	123.66	1.4259 U	36.705	134.73 mU	41.256	629.25 mU	150.25
2 100.000 000	833.73 mU	121.53	1.3524 U	34.544	138.42 mU	39.367	639.79 mU	148.21
2 200.000 000	834.92 mU	119.23	1.2885 U	32.201	142.75 mU	38.267	642.22 mU	146.78
2 300.000 000	836.52 mU	117.34	1.2192 U	29.821	147.57 mU	36.681	645.15 mU	145.54
2 400.000 000	840.11 mU	115.29	1.1746 U	27.779	150.95 mU	35.369	652.07 mU	144.33
2 500.000 000	841.88 mU	113.25	1.1257 U	25.995	155.15 mU	34.088	653.43 mU	143.03

CHARACTERISTICS CURVES

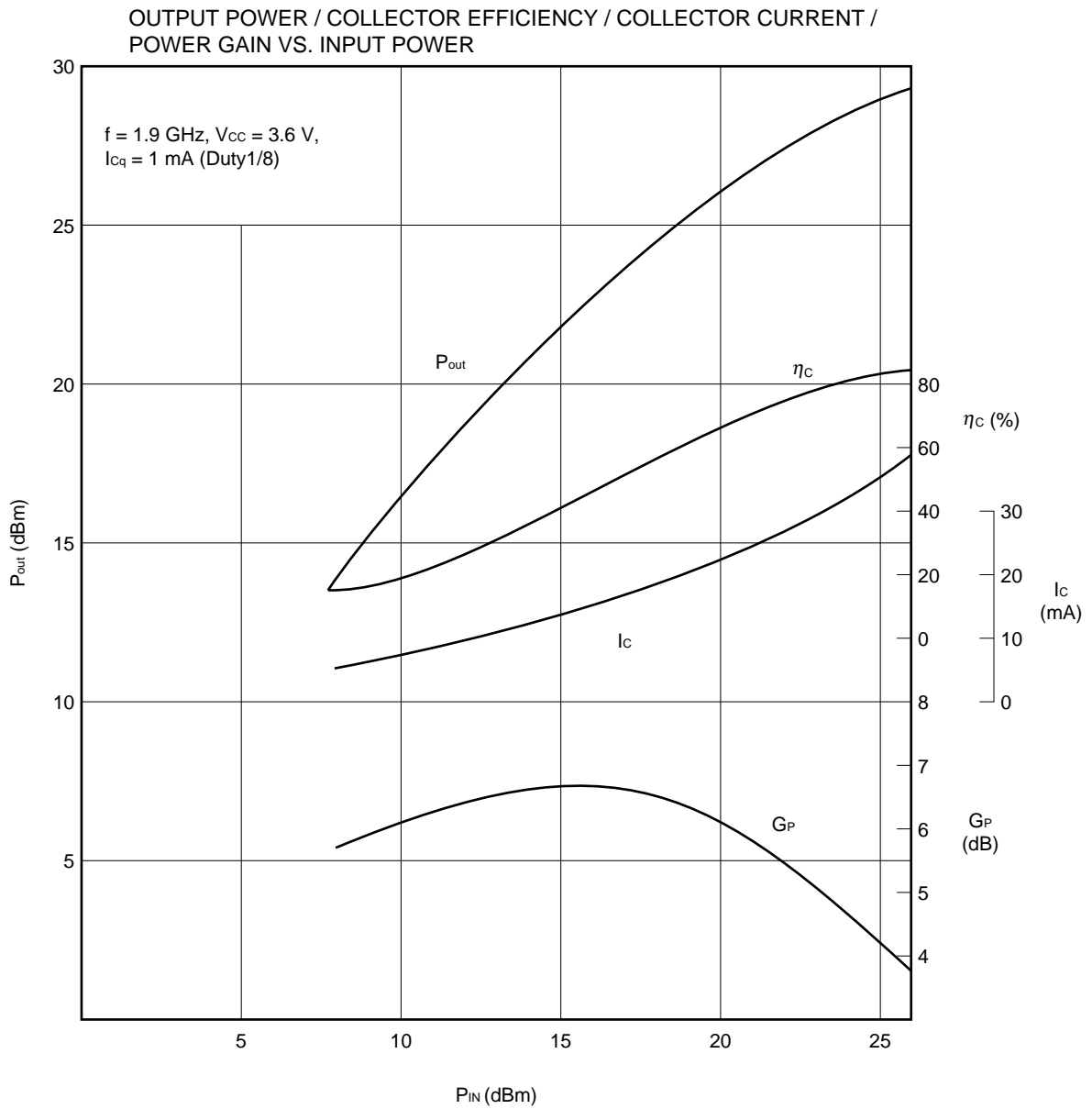

(Reference) Data from the above graph

P_{-1}	27.5	dBm
η_c (at P_{-1})	72	%
I_c (at P_{-1})	27	mA
G_L	6.7	dB

Note I_{CQ} is stand for the collector current when input power off.
Above the I_{CQ} and I_c are showing current value at 1/8 duty operation.
In case of CW (continuous wave) operation, the current value becomes eight times.
Actual bias condition; $V_{CE} = 3.6 \text{ V}$, $I_{CQ} = 8 \text{ mA}$ @ $P_{in} = \text{OFF}$.

Z_{IN} (Ω), Z_{OUT} (Ω) Data

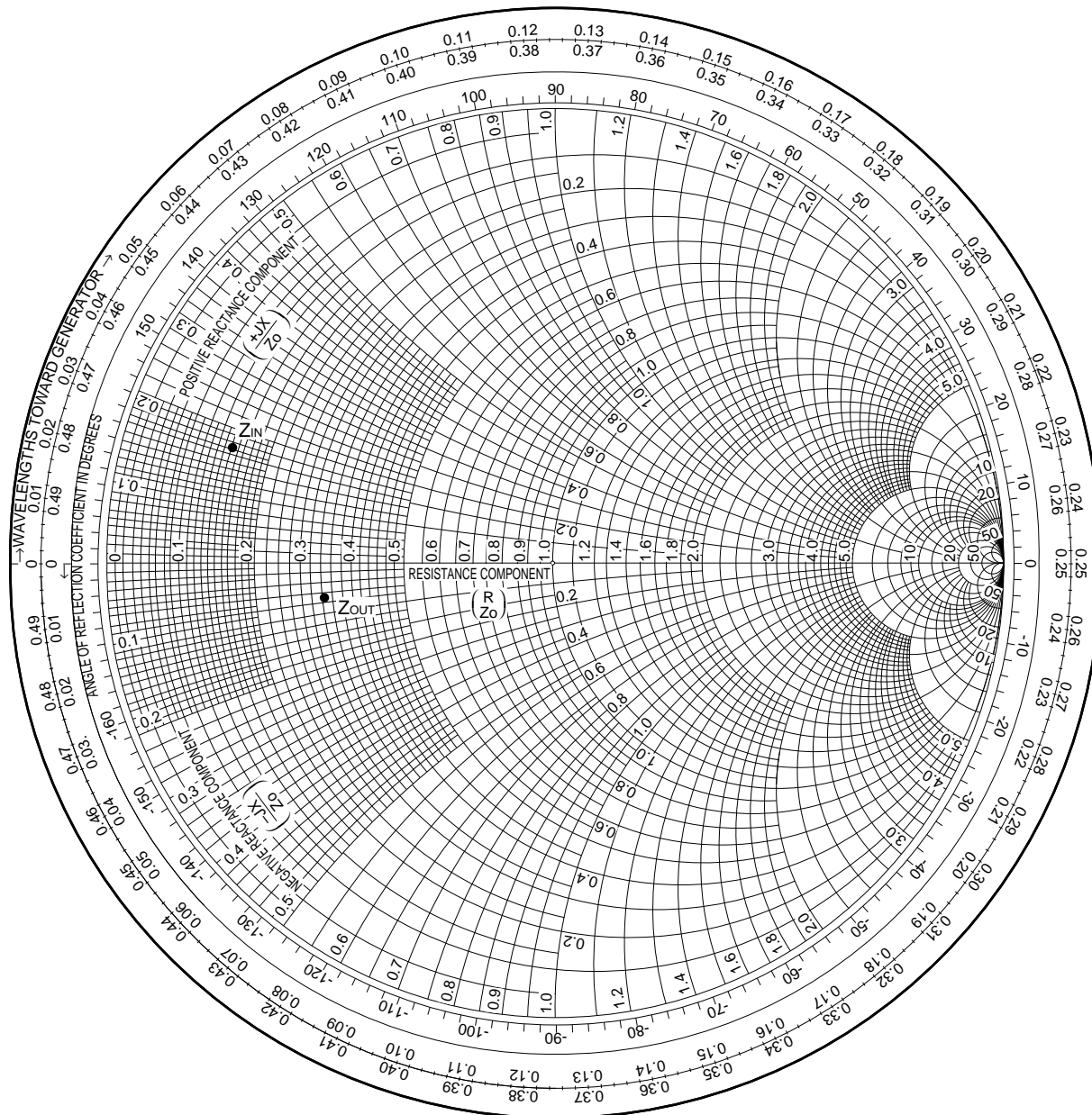

V_{CC} = 3.6 V, I_{cq} = 1 mA, duty = 1/8

f (GHz)	Z _{in} (Ω)	Z _{out} (Ω)
1.9	7.05 + j8.52	16.0 - j3.69

(REFERENCE PERFORMANCE)

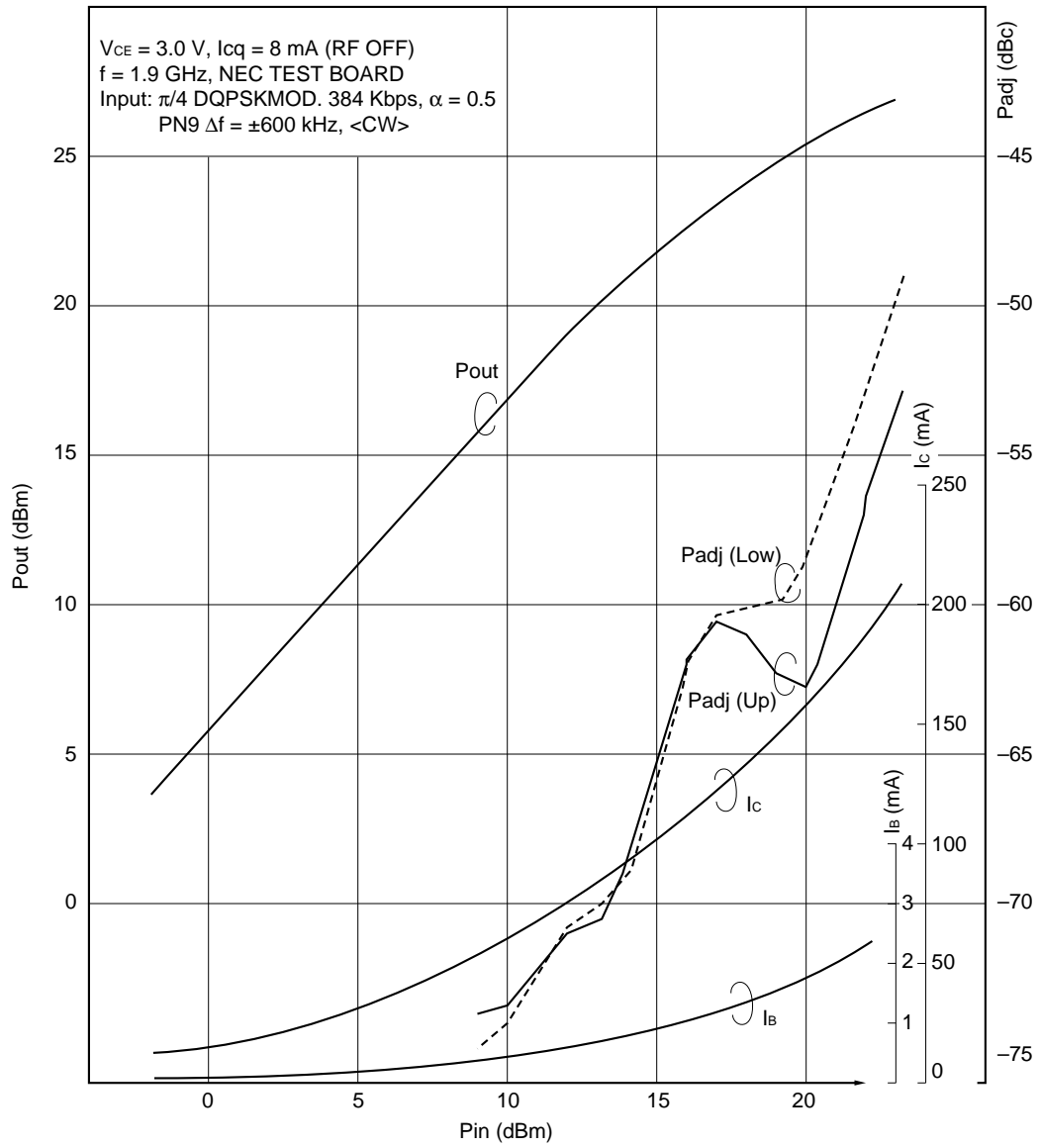

TEST BOARD Unit (mm)

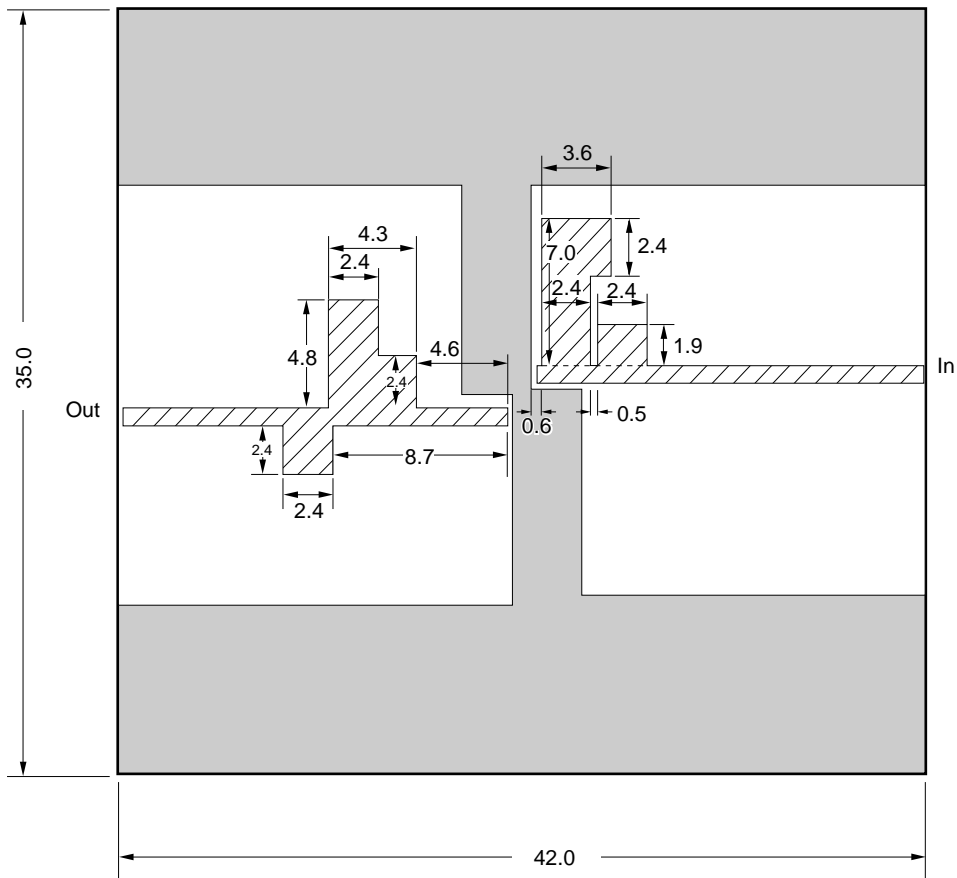

t = 0.4 mm, polyimide substrate

[MEMO]

The application circuit and circuit constants shown in this document are for reference only and may not be employed for mass production of the application system.

No part of this document may be copied or reproduced in any form or by any means without the prior written consent of NEC Corporation. NEC Corporation assumes no responsibility for any errors which may appear in this document.

NEC Corporation does not assume any liability for infringement of patents, copyrights or other intellectual property rights of third parties by or arising from use of a device described herein or any other liability arising from use of such device. No license, either express, implied or otherwise, is granted under any patents, copyrights or other intellectual property rights of NEC Corporation or others.

While NEC Corporation has been making continuous effort to enhance the reliability of its semiconductor devices, the possibility of defects cannot be eliminated entirely. To minimize risks of damage or injury to persons or property arising from a defect in an NEC semiconductor device, customer must incorporate sufficient safety measures in its design, such as redundancy, fire-containment, and anti-failure features.

NEC devices are classified into the following three quality grades:

"Standard", "Special", and "Specific". The Specific quality grade applies only to devices developed based on a customer designated "quality assurance program" for a specific application. The recommended applications of a device depend on its quality grade, as indicated below. Customers must check the quality grade of each device before using it in a particular application.

Standard: Computers, office equipment, communications equipment, test and measurement equipment, audio and visual equipment, home electronic appliances, machine tools, personal electronic equipment and industrial robots

Special: Transportation equipment (automobiles, trains, ships, etc.), traffic control systems, anti-disaster systems, anti-crime systems, safety equipment and medical equipment (not specifically designed for life support)

Specific: Aircrafts, aerospace equipment, submersible repeaters, nuclear reactor control systems, life support systems or medical equipment for life support, etc.

The quality grade of NEC devices in "Standard" unless otherwise specified in NEC's Data Sheets or Data Books. If customers intend to use NEC devices for applications other than those specified for Standard quality grade, they should contact NEC Sales Representative in advance.

Anti-radioactive design is not implemented in this product.

This datasheet has been download from:

www.datasheetcatalog.com

Datasheets for electronics components.