

Darlington 2SD2439

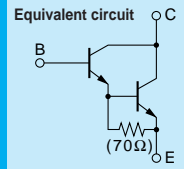

Silicon NPN Triple Diffused Planar Transistor (Complement to type 2SB1588)

Application : Audio, Series Regulator and General Purpose

Absolute maximum ratings (Ta=25°C)

Symbol	2SD2439	Unit
V _{CB0}	160	V
V _{CE0}	150	V
V _{EB0}	5	V
I _C	10	A
I _B	1	A
P _C	80(T _C =25°C)	W
T _J	150	°C
T _{stg}	-55 to +150	°C

Electrical Characteristics (Ta=25°C)

Symbol	Conditions	2SD2439	Unit
I _{CB0}	V _{CB} =160V	100max	μA
I _{EB0}	V _{EB} =5V	100max	μA
V _{(BR)CEO}	I _C =30mA	150min	V
h _{FE}	V _{CE} =4V, I _C =7A	5000min*	
V _{CE(sat)}	I _C =7A, I _B =7mA	2.5max	V
V _{BE(sat)}	I _C =7A, I _B =7mA	3.0max	V
f _T	V _{CE} =12V, I _E =-2A	55typ	MHz
COB	V _{CB} =10V, f=1MHz	95typ	pF

*h_{FE} Rank \bar{O} (5000 to 12000), P(6500 to 20000), Y(15000 to 30000)

External Dimensions FM100(TO3PF)

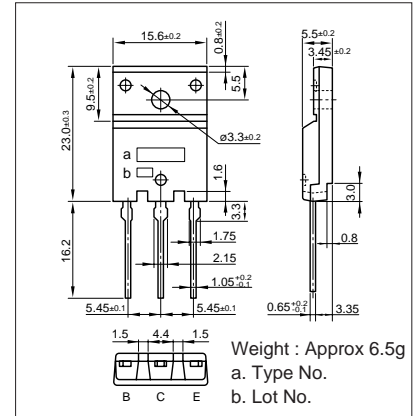

Typical Switching Characteristics (Common Emitter)

V _{CC} (V)	R _L (Ω)	I _C (A)	V _{BB1} (V)	V _{BB2} (V)	I _{B1} (mA)	I _{B2} (mA)	t _{on} (μs)	t _{stg} (μs)	t _f (μs)
70	10	7	10	-5	7	-7	0.5typ	10.0typ	1.1typ

I_C-V_{CE} Characteristics (Typical)

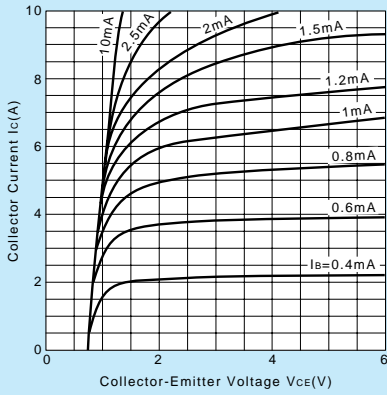

V_{CE(sat)}-I_B Characteristics (Typical)

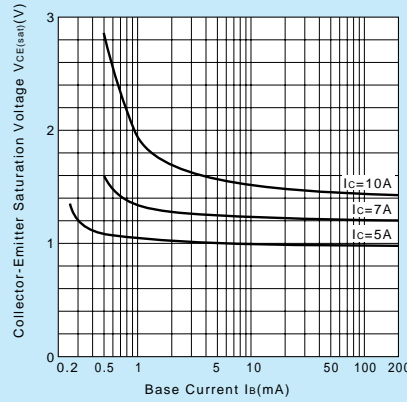

I_C-V_{BE} Temperature Characteristics (Typical)

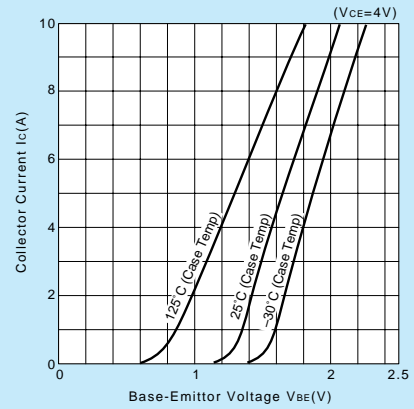

h_{FE}-I_C Characteristics (Typical)

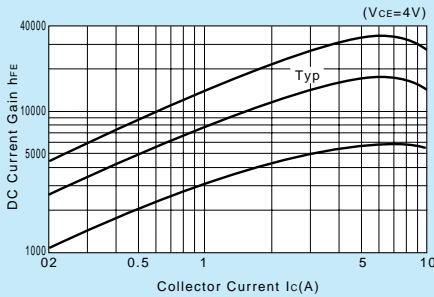

h_{FE}-I_C Temperature Characteristics (Typical)

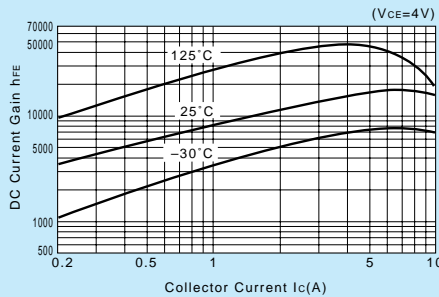

θ_{j-a}-t Characteristics

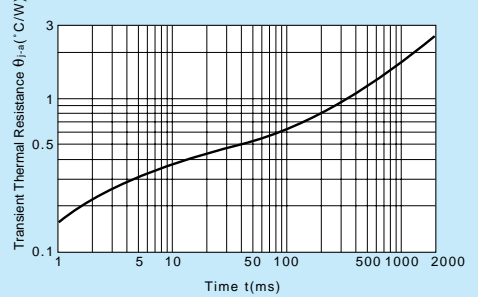

f_T-I_E Characteristics (Typical)

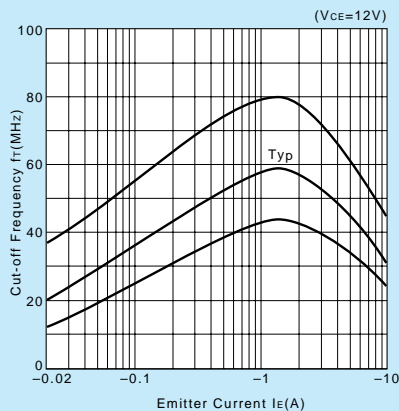

Safe Operating Area (Single Pulse)

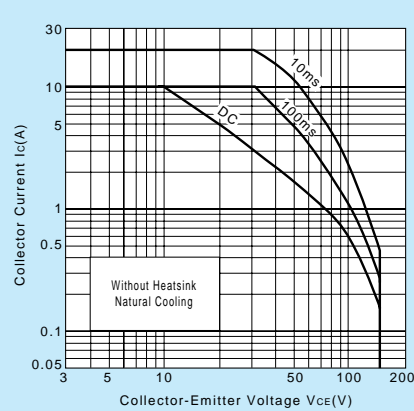

P_C-T_a Derating

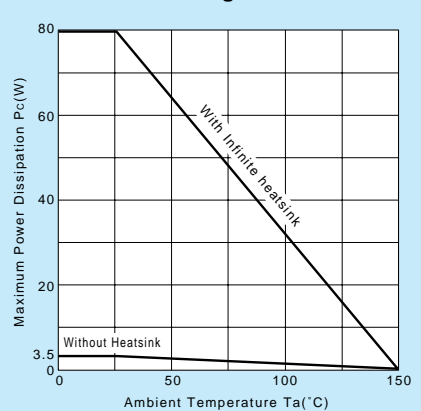

This datasheet has been downloaded from:

www.DatasheetCatalog.com

Datasheets for electronic components.