



Micro Commercial Components
 21201 Itasca Street Chatsworth
 CA 91311
 Phone: (818) 701-4933
 Fax: (818) 701-4939

MURB1605CT THRU MURB1660CT

Features

- High Current Capability
- Low Reverse Leakage
- Low Forward Voltage Drop
- High Current Capability
- Super Fast Switching Speed For High Efficiency

**16 Amp
 Super Fast
 Recovery Rectifier
 50 to 600 Volts**

Maximum Ratings

- Operating Temperature: -55°C to +150°C
- Storage Temperature: -55°C to +150°C

MCC Catalog Number	Maximum Recurrent Peak Reverse Voltage	Maximum RMS Voltage	Maximum DC Blocking Voltage
MURB1605CT	50V	35V	50V
MURB1610CT	100V	70V	100V
MURB1620CT	200V	140V	200V
MURB1640CT	400V	280V	400V
MURB1660CT	600V	420V	600V

Electrical Characteristics @ 25°C Unless Otherwise Specified

Average Forward Current	$I_{F(AV)}$	16 A	$T_A = 100^\circ\text{C}$
Peak Forward Surge Current	I_{FSM}	125A	8.3ms, half sine
Maximum Forward Voltage Drop Per Element	V_F	0.95V 1.30V 1.50V	$I_{FM} = 8 \text{ A per element};$ $T_A = 25^\circ\text{C}^*$
Maximum DC Reverse Current At Rated DC Blocking Voltage	I_R	5.0μA 500uA	$T_A = 25^\circ\text{C}$ $T_J = 100^\circ\text{C}$
Maximum Reverse Recovery Time	T_{rr}	35ns 50ns	$I_F=0.5\text{A}, I_R=1.0\text{A},$ $I_{rr}=0.25\text{A}$

*Pulse Test: Pulse Width 300μsec, Duty Cycle 1%

D²-PACK

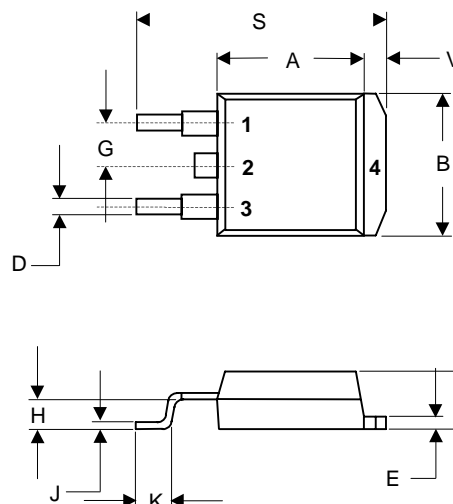

DIM	INCHES		MM		NOTE
	MIN	MAX	MIN	MAX	
A	.340	.380	8.64	9.65	
B	.380	.405	9.65	10.29	
C	.160	.190	4.06	4.83	
D	.020	.035	.051	0.89	
E	.045	.055	1.14	1.40	
G	.100	BSC	2.54	BSC	
H	.080	.110	2.03	2.79	
J	.018	.025	0.46	0.64	
K	.090	.110	2.29	2.79	
S	.575	.625	14.60	15.88	
V	.045	.055	1.14	1.40	

MBRB1605CT thru MBRB1660CT



Figure 1
Typical Forward Characteristics

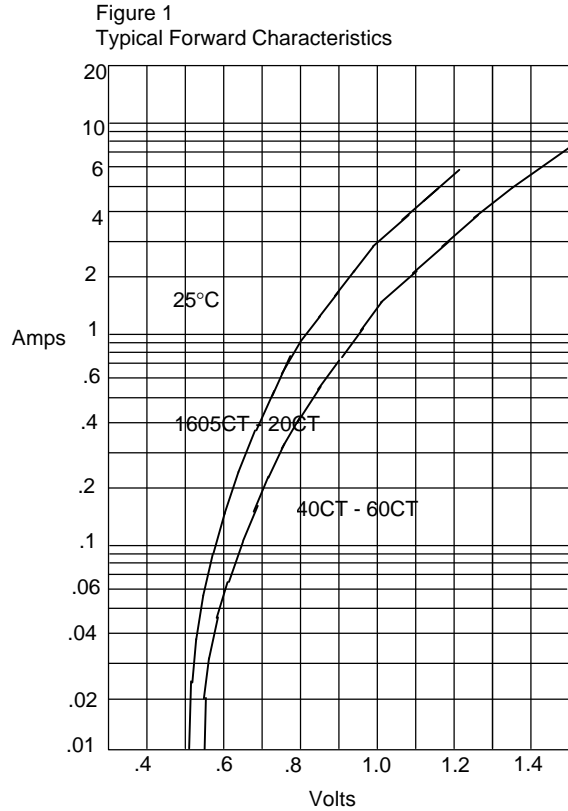

Instantaneous Forward Current - Amperes versus
Instantaneous Forward Voltage - Volts

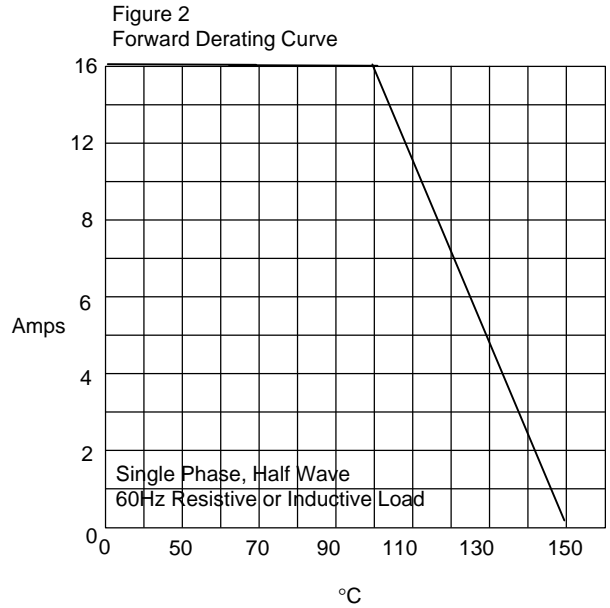

Average Forward Rectified Current - Amperes versus
Ambient Temperature - °C

Figure 3
Junction Capacitance

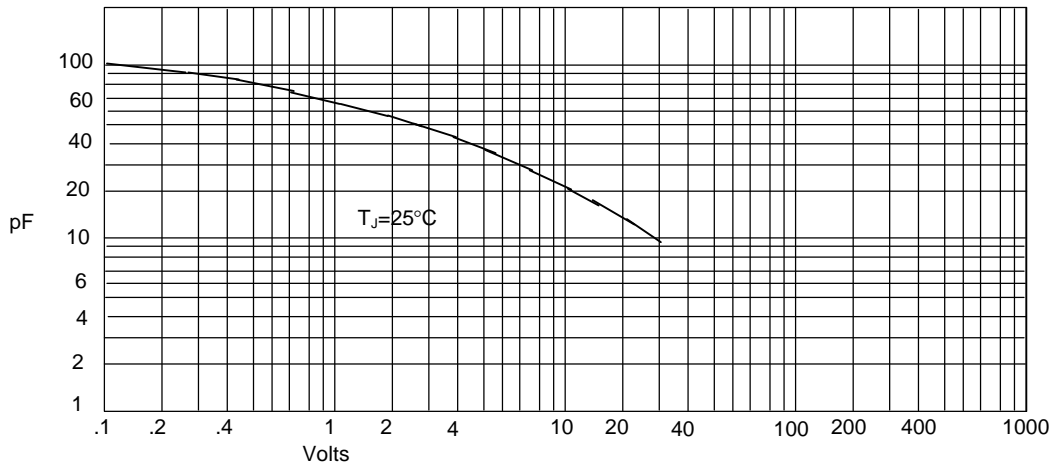

Junction Capacitance - pF versus
Reverse Voltage - Volts

MURB1605CT thru MURB1660CT

Figure 4
Typical Reverse Characteristics

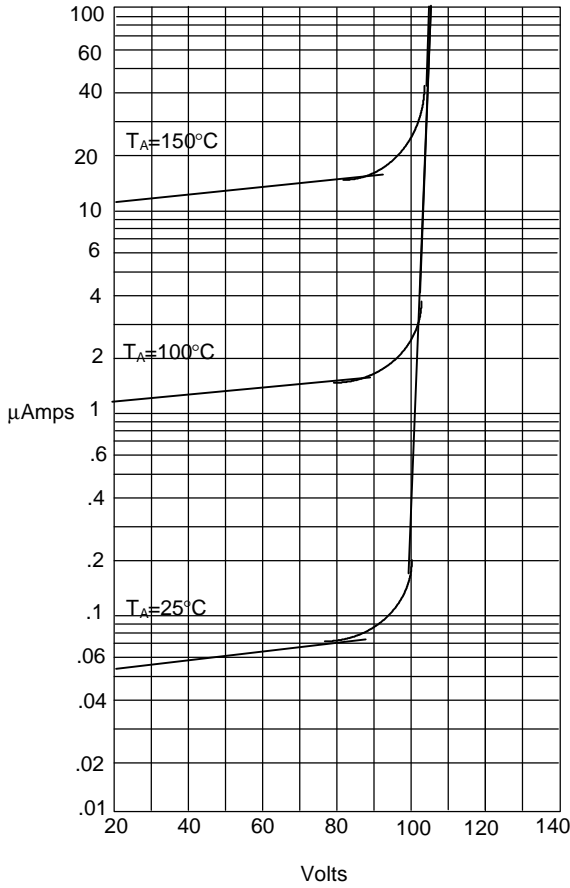

Instantaneous Reverse Leakage Current - MicroAmperes versus
Percent Of Rated Peak Reverse Voltage - Volts

Figure 5
Maximum Non-Repetitive Forward Surge Current

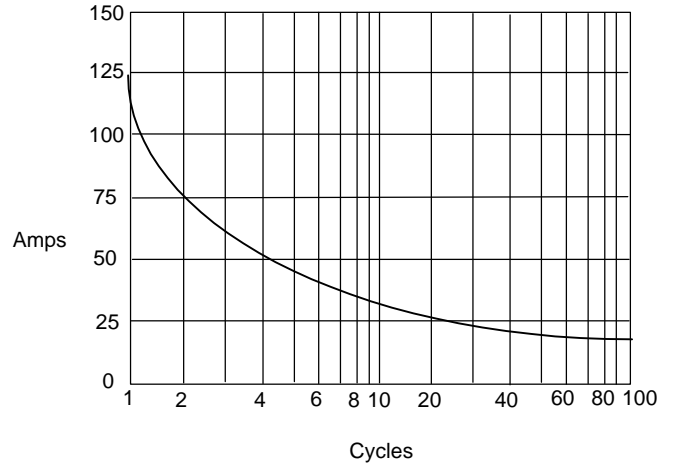

Peak Forward Surge Current - Amperes versus
Number Of Cycles At 60Hz - Cycles

Figure 6
Reverse Recovery Time Characteristic And Test Circuit Diagram

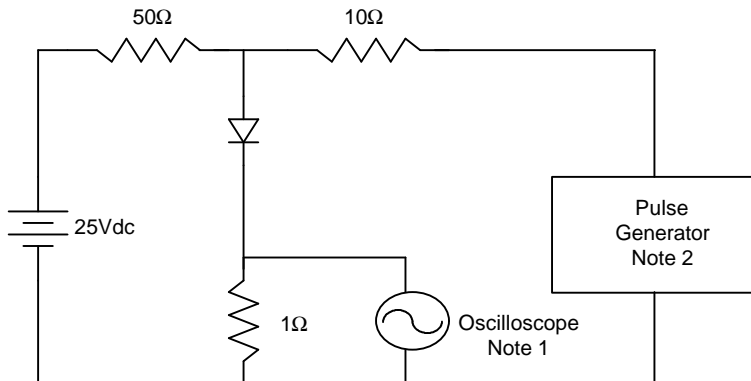

- Notes:
1. Rise Time = 7ns max.
Input impedance = 1 megohm, 22pF
 2. Rise Time = 10ns max.
Source impedance = 50 ohms
 3. Resistors are non-inductive

