

**MNLM111-X REV 0A0**

 Original Creation Date: 06/28/95  
 Last Update Date: 11/12/98  
 Last Major Revision Date: 08/14/98

**VOLTAGE COMPARATOR**
**General Description**

The LM111 is a voltage comparator that has input currents nearly a thousand times lower than devices such as the LM106 or LM710. It is also designed to operate over a wider range of supply voltages; from standard  $\pm 15V$  op amp supplies down to the single 5V supply used for IC logic. The output is compatible with RTL, DTL and TTL as well as MOS circuits. Further, it can drive lamp or relay switching voltages up to 50V at currents as high as 50 mA.

Both the inputs and the output of the LM111 can be isolated from system ground, and the output can drive loads referred to ground, the positive supply or the negative supply. Offset balancing and strobe capability are provided, and outputs can be wire OR'ed. Although slower than the LM106 and LM710 (200 ns response time vs 40 ns) the device is also much less prone to spurious oscillations. The LM111 has the same pin configuration as LM106 and LM710.

**Industry Part Number**

LM111

**Prime Die**

LM111

**NS Part Numbers**

 LM111E/883  
 LM111H/883  
 LM111J-8/883  
 LM111J/883  
 LM111W/883  
 LM111WG/883

**Processing**

MIL-STD-883, Method 5004

**Quality Conformance Inspection**

MIL-STD-883, Method 5005

**Subgrp Description Temp ( °C)**

1	Static tests at	+25
2	Static tests at	+125
3	Static tests at	-55
4	Dynamic tests at	+25
5	Dynamic tests at	+125
6	Dynamic tests at	-55
7	Functional tests at	+25
8A	Functional tests at	+125
8B	Functional tests at	-55
9	Switching tests at	+25
10	Switching tests at	+125
11	Switching tests at	-55

**Features**

- Operates from single 5V supply
- Input current: 150 nA max. over temperature
- Offset current: 20 nA max. over temperature
- Differential input voltage range:  $\pm 30V$
- Power consumption: 135 mW at  $\pm 15V$

**(Absolute Maximum Ratings)**

(Note 1)

Total Supply Voltage		36V
Output to Negative Supply Voltage		50V
Ground to Negative Supply Voltage		30V
Differential Input Voltage		± 30V
Input Voltage (Note 3)		± 15V
Power Dissipation (Note 2)		500mW
Output Short Circuit Duration		10 Sec
Operating Temperature Range		-55 C to +125 C
Thermal Resistance		
ThetaJA		
Metal Can Pkg	(Still Air @ 0.5W) (500LF/Min Air flow @ 0.5W)	162 C/W 92 C/W
CERDIP (8-LEAD)	(Still Air @ 0.5W) (500LF/Min Air flow @ 0.5W)	134 C/W 76 C/W
CERDIP (14-LEAD)	(Still Air @ 0.5W) (500LF/Min Air flow @ 0.5W)	97 C/W 65 C/W
CERPACK (10-Lead)	(Still Air @ 0.5W) (500LF/Min Air flow @ 0.5W)	231 C/W 153 C/W
LCC (20-Lead)	(Still Air @ 0.5W) (500LF/Min Air flow @ 0.5W)	90 C/W 65 C/W
CERAMIC SOIC (10-Lead)	(Still Air @ 0.5W) (500LF/Min Air flow @ 0.5W)	231 C/W 153 C/W
ThetaJC		
Metal Can Pkg		50 C/W
CERDIP ( 8-Lead)		21 C/W
CERDIP (14-Lead)		20 C/W
CERPACK (10-Lead)		24 C/W
LCC (20-Lead)		21 C/W
CERAMIC SOIC (10-Lead)		24 C/W
Storage Temperature Range		-65 C to 150 C
Lead Temperature (Soldering, 10 seconds)		260 C
Voltage at Strobe Pin		V+ -5V
ESD Rating (Note 4)		300V

**(Absolute Maximum Ratings)(Continued)**

(Note 1)

## Package Weight

(Typical)

Metal Can Pkg	TBD
CERDIP ( 8-Lead)	TBD
CERDIP (14-Lead)	TBD
CERPACK (10-Lead)	TBD
CERAMIC SOIC	220mg

- Note 1: Absolute Maximum Ratings indicate limits beyond which damage to the device may occur. Operating Ratings indicate conditions for which the device is functional, but do not guarantee specific performance limits. For guaranteed specifications and test conditions, see the Electrical Characteristics. The guaranteed specifications apply only for the test conditions listed. Some performance characteristics may degrade when the device is not operated under the listed test conditions.
- Note 2: The maximum power dissipation must be derated at elevated temperatures and is dictated by  $T_{jmax}$  (maximum junction temperature),  $\theta_{JA}$  (package junction to ambient thermal resistance), and  $T_A$  (ambient temperature). The maximum allowable power dissipation at any temperature is  $P_{Dmax} = (T_{jmax} - T_A)/\theta_{JA}$  or the number given in the Absolute Maximum Ratings, whichever is lower.
- Note 3: This rating applies for  $\pm 15V$  supplies. The positive input voltage limit is 30V above the negative supply. The negative input voltage limit is equal to the negative supply voltage or 30V below the positive supply, whichever is less.
- Note 4: Human body model, 1.5K Ohms in series with 100pF.

## Electrical Characteristics

### DC PARAMETERS

(The following conditions apply to all the following parameters, unless otherwise specified.)  
DC:  $V_{56}=0$ ,  $R_s=0$  Ohm,  $\pm V_{cc}=\pm 15V$ ,  $V_{cm}=0$ ,  $V_{out}=1.4V$  WRT  $-V_{cc}$

SYMBOL	PARAMETER	CONDITIONS	NOTES	PIN-NAME	MIN	MAX	UNIT	SUB-GROUPS
Iio	Input Offset Current	Vcm=13.5V, Rs=50K Ohms			-10	10	nA	1
					-20	20	nA	2, 3
		Vcm=13.5V, V85=V86=0V, Rs=50K Ohms			-30	30	nA	1
		Vcm=-14.5V, Rs=50K Ohms			-10	10	nA	1
					-20	20	nA	2, 3
		Vcm=-14.5V, V85=V86=0V, Rs=50K Ohms			-30	30	nA	1
		Rs=50K Ohms			-10	10	nA	1
					-20	20	nA	2, 3
		V85=V86=0V, Rs=50K Ohms			-30	30	nA	1
Iib	Input Bias Current	Vcm=13.5V, Rs=50K Ohms				100	nA	1
						150	nA	2, 3
		Vcm = -14.5V, Rs=50K Ohms				100	nA	1
						150	nA	2, 3
		Rs=50K Ohms				100	nA	1
						150	nA	2, 3
Ilo	Output Leakage Current	Vcc=± 18V, Vout=35V WRT -Vcc, I5+I6=5mA				10	nA	1
						500	nA	2, 3
Ilg	Ground Leakage Current	Vcc= ± 18V, Vout=50V WRT -Vcc, I5+I6=5mA				25	nA	1
						500	nA	2
Vsat	Saturation Voltage	Vin= -5mV, I7=50mA				1.5	V	1, 2, 3
		Vin= -6mV, I7=8mA				0.4	V	1, 2, 3
Icc-	Negative Supply Current					5	mA	1, 2
						15	mA	3
Icc+	Positive Supply Current					6	mA	1, 2
						15	mA	3
I11	Input Leakage Current	Vcc= ± 18V, V28=1V, V38=30V, Vout=50V WRT -Vcc, I5+I6=5mA				10	nA	1
						30	nA	2
I12	Input Leakage Current	Vcc= ± 18V, V38=1V, V28=30V, Vout=50V WRT -Vcc, I5+I6=5mA				10	nA	1
						30	nA	2

## Electrical Characteristics

### DC PARAMETERS (Continued)

(The following conditions apply to all the following parameters, unless otherwise specified.)  
DC:  $V_{56}=0$ ,  $R_s=0$  Ohm,  $\pm V_{cc}=\pm 15V$ ,  $V_{cm}=0$ ,  $V_{out}=1.4V$  WRT  $-V_{cc}$

SYMBOL	PARAMETER	CONDITIONS	NOTES	PIN-NAME	MIN	MAX	UNIT	SUB-GROUPS
Vo(STB)	Collector Output Voltage (ST)		1		14		V	1
		ISTB = 3mA	1		14		V	1
Vio	Input Offset Voltage	Vcm=13.5V			-3	3	mV	1
					-4	4	mV	2, 3
		Vcm=13.5V, V85=V86=0V			-3	3	mV	1
		Vcm= -14.5V			-3	3	mV	1
					-4	4	mV	2, 3
		Vcm= -14.5V, V85=V86=0V			-3	3	mV	1
					-3	3	mV	1
					-4	4	mV	2, 3
		V85=V86=0V			-3	3	mV	1
		Vout=0.4V, +Vcc=4.5V, -Vcc=0V, Vcm=3V			-5	5	mV	1
					-6	6	mV	2, 3
		Vout=4.5V, +Vcc=4.5V, -Vcc=0V, Vcm=3V			-3	3	mV	1
					-4	4	mV	2, 3
		Vout=0.4V, +Vcc=4.5V, -Vcc=0V, Vcm=0.5V			-5	5	mV	1
			-6	6	mV	2, 3		
Avs	Large Signal Gain	-12V $\leq$ Vout $\leq$ 35V, Rl=1K Ohm	2		40		V/mV	4
			2		30		V/mV	5, 6

### AC PARAMETERS

(The following conditions apply to all the following parameters, unless otherwise specified.)  
AC:  $V_{56}=0$ ,  $R_s=0$  Ohm,  $\pm V_{cc}=\pm 15V$ ,  $V_{cm}=0$ ,  $V_{out}=1.4V$  WRT  $-V_{cc}$

tr	Response Time					400	nS	7
----	---------------	--	--	--	--	-----	----	---

## Electrical Characteristics

### DC PARAMETERS: DRIFT VALUES

(The following conditions apply to all the following parameters, unless otherwise specified.)  
 DC:  $V_{56}=0$ ,  $R_s=0$  Ohms,  $\pm V_{cc} = \pm 15V$ ,  $V_{cm}=0$ ,  $V_{out}=1.4V$  WRT  $-V_{cc}$ . "Deltas not required on B-Level product.  
 Deltas required for S-Level product ONLY as specified on Internal Processing Instructions (IPI)."

SYMBOL	PARAMETER	CONDITIONS	NOTES	PIN-NAME	MIN	MAX	UNIT	SUB-GROUPS
Iib	Input Bias Current	$R_s=50K$ Ohms			-10	10	nA	1
Vio	Input Offset Voltage				-0.5	0.5	mV	1

Note 1: Tested on LTX system.

Note 2: Datalog reading in K = V/mV.

## Graphics and Diagrams

GRAPHICS#	DESCRIPTION
05815HRA3	LCC (E), TYPE C, 20 TERMINAL (B/I CKT)
06047HRA2	CERDIP (J), 8 LEAD (B/I CKT)
08358HRB2	METAL CAN, (H) TO-99, 8 LEAD, .200 DIA P.C. (B/I CKT)
08570HRA1	CERDIP (J), 14 LEAD (B/I CKT)
09569HRC2	CERPACK (W), 10 LEAD (B/I CKT)
E20ARE	LCC (E), TYPE C, 20 TERMINAL (P/P DWG)
H08CRF	METAL CAN (H), TO-99, 8LD, .200 DIA P.C. (P/P DWG)
J08ARL	CERDIP (J), 8 LEAD (P/P DWG)
J14ARH	CERDIP (J), 14 LEAD (P/P DWG)
P000264A	METAL CAN (H), 8 LEAD (PINOUT)
P000265A	CERDIP (J), 8 LEAD (PINOUT)
P000266A	CERDIP (J), 14 LEAD (PINOUT)
P000267A	CERPACK (W), 10 LEAD (PINOUT)
P000314B	LCC (E), 20 LEAD (PINOUT)
P000373A	CERAMIC SOIC (WG), 10 LEAD (PINOUT)
W10ARG	CERPACK (W), 10 LEAD (P/P DWG)
WG10ARC	CERAMIC SOIC (WG), 10 LEAD (P/P DWG)

See attached graphics following this page.



REVISIONS			
LTR	DESCRIPTION	E.C.N.	DATE
E	REVISE AND REDRAW	10005	02/10/94 DEG/

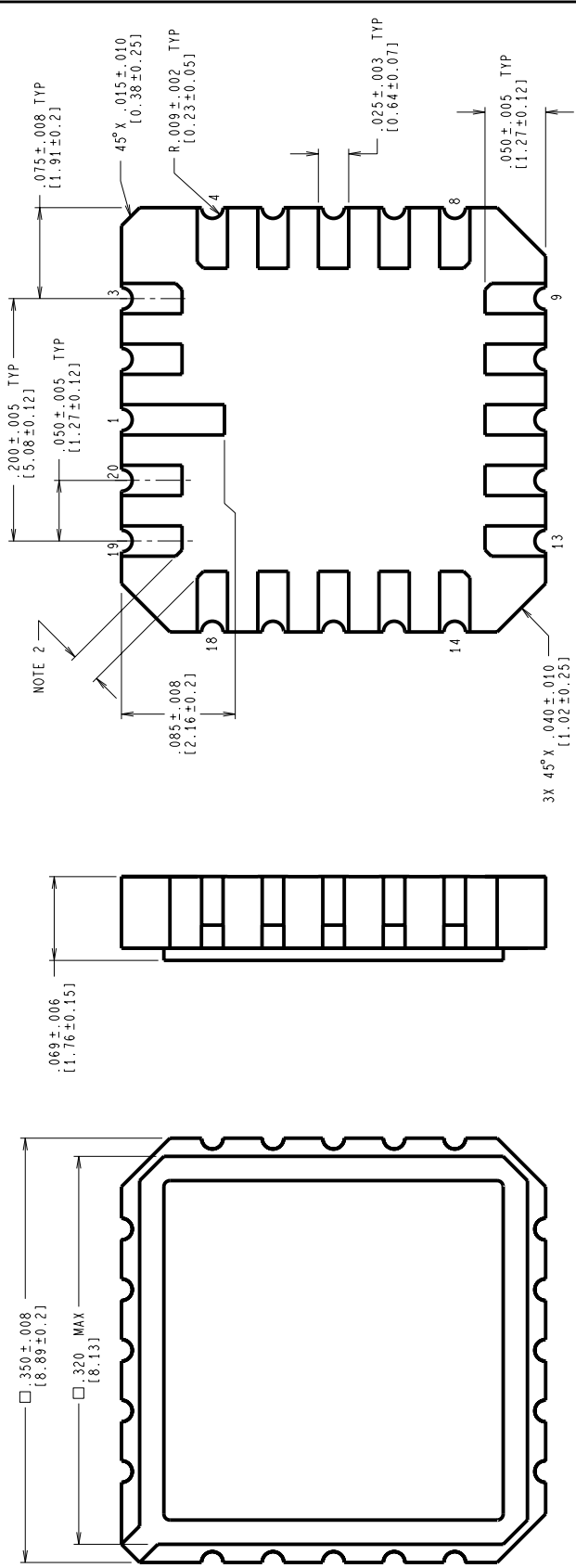

- NOTES: UNLESS OTHERWISE SPECIFIED.
- LEAD FINISH TO BE ONE OF THE FOLLOWING:
    - 50 MICRONS/12.7 MICROMETERS MINIMUM GOLD PLATING OVER 50-350 MICRONS/1.27-8.89 MICROMETERS NICKEL.
    - SOLDER DIP. SOLDER THICKNESS PER LATEST REVISION OF MIL-STD-1835.
  - CORNER PADS MAY HAVE A  $45^\circ \times 0.20$  IN/0.51mm MAXIMUM CHAMFER TO ACCOMPLISH THE .015 IN/0.38mm DIMENSION.
  - REFERENCE JEDEC REGISTRATION MS-004, VARIATION CB, DATED 7/90.

CONTROLLING DIMENSION IS INCH  
VALUES IN [ ] ARE MILLIMETERS

MIL/AERO  
CONFIGURATION CONTROL

APPROVALS		DATE
DRN	<i>Deane Gedy</i>	02/10/94
DTG - CHK.		
ENGR - CHK.		
APPROVAL		

SCALE	N/A
SIZE	C
DRAWING NUMBER	MKT-E20A
REV	E

  

2300 Semiconductor Drive, Santa Clara, Ca. 95052-8000	
LEADLESS CHIP CARRIER, TYPE C, 20 TERMINAL	



REVISIONS

LTR	DESCRIPTION	E.C.N.	DATE	BY/APP'D
L	REVISE PER CURRENT STD; REDRAW	10002	09/21/93	TL/

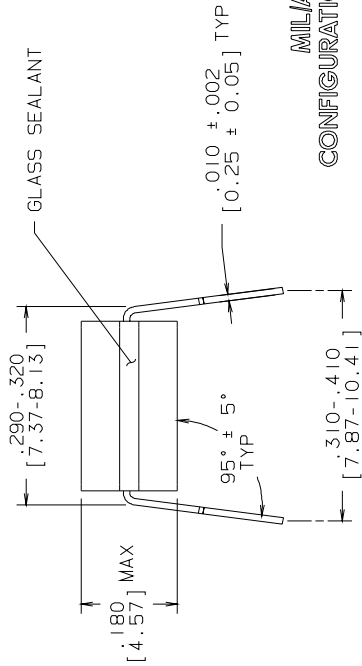
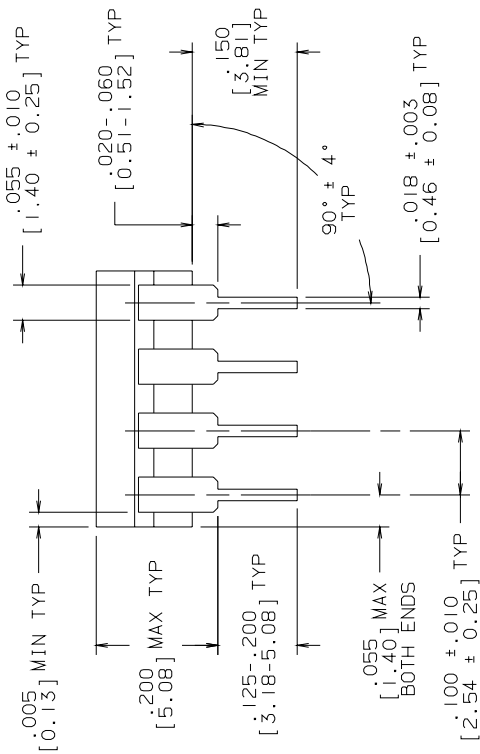
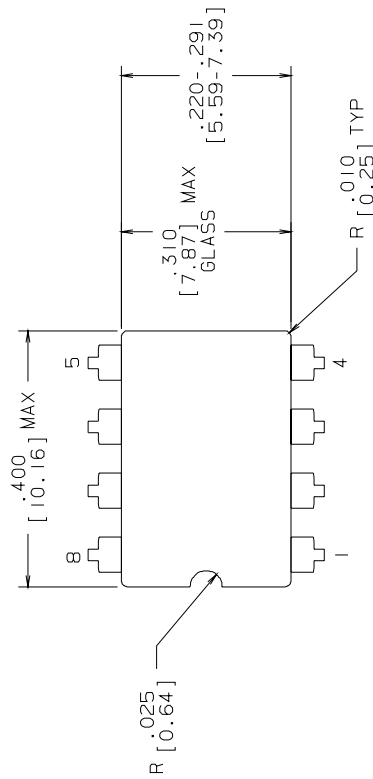

MILAERO  
CONFIGURATION CONTROL  
MIL-M-38510  
CONFIGURATION CONTROL

CONTROLLING DIMENSION: INCH			
APPROVALS	DATE		
DRAWN <i>T. LEQUANG</i>	09/21/93		
DFTG. CHK.			
ENGR. CHK.			
APPROVAL			
SCALE	SIZE	DRAWING NUMBER	REV
N/A	B	MKT-J08A	L
DO NOT SCALE DRAWING	SHEET	OF	
	1	1	1

NATIONAL SEMICONDUCTOR CORPORATION  
2900 Semiconductor Drive, Santa Clara, CA 95052-8090

CERDIP (J),  
8 LEAD

NOTES: UNLESS OTHERWISE SPECIFIED

- LEAD FINISH TO BE 200 MICROMETERS / 5.08 MICROMETERS MINIMUM SOLDER MEASURED AT THE CREST OF THE MAJOR FLATS.
- JEDEC REGISTRATION MO-036, VARIATION AA, DATED 04/1981.

R E V I S I O N S			
LTR	DESCRIPTION	E.C.N.	DATE
H	REVISE PER CURRENT STD; REDRAW	10001	09/15/93
			TL/

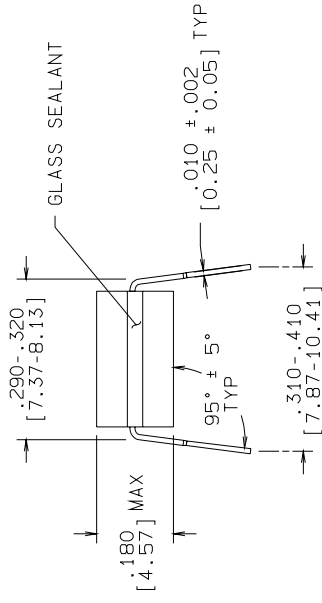
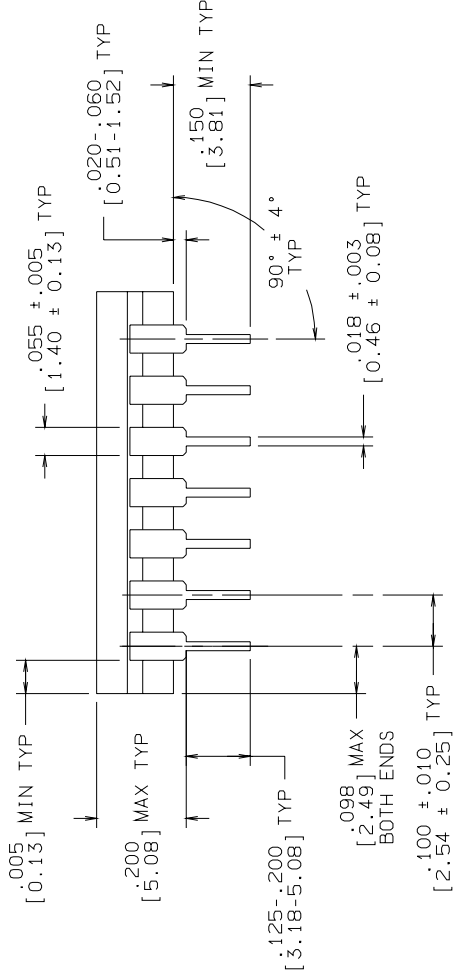
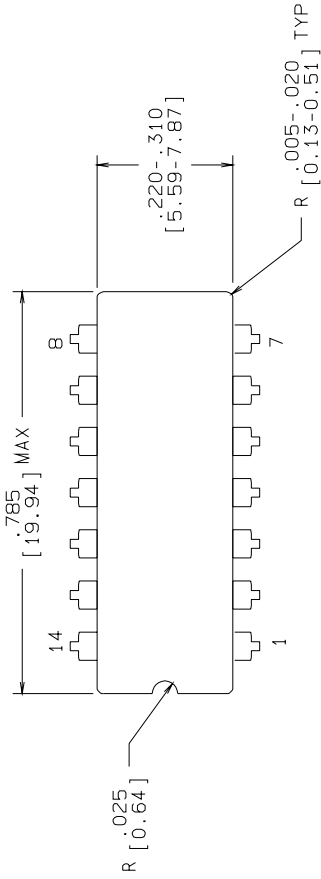

CONTROLLING DIMENSION: INCH

- NOTES: UNLESS OTHERWISE SPECIFIED
1. LEAD FINISH TO BE 200 MICRONS / 5.08 MICROMETERS MINIMUM SOLDER MEASURED AT THE CREST OF THE MAJOR FLATS.
  2. JEDEC REGISTRATION MO-036, VARIATION AB, DATED 04/1981.

APPROVALS	DATE	MIL/AERO	CONFIGURATION CONTROL	CONFIGURATION CONTROL	MIL-M-38510
DRAWN: <b>LEQUANG</b>	09/15/93				
DFTG. CHK.					
ENGR. CHK.					
APPROVAL					

		NATIONAL SEMICONDUCTOR CORPORATION 2900 Semiconductor Drive, Santa Clara, CA 95052-8090	
--	--	--	--

CERDIP (J),  
14 LEAD,

 PROJECTION INCH [MM]	SCALE	SIZE	DRAWING NUMBER	REV
	N/A	B	MKT-J14A	H
DO NOT SCALE DRAWING			SHEET 1 OF 1	

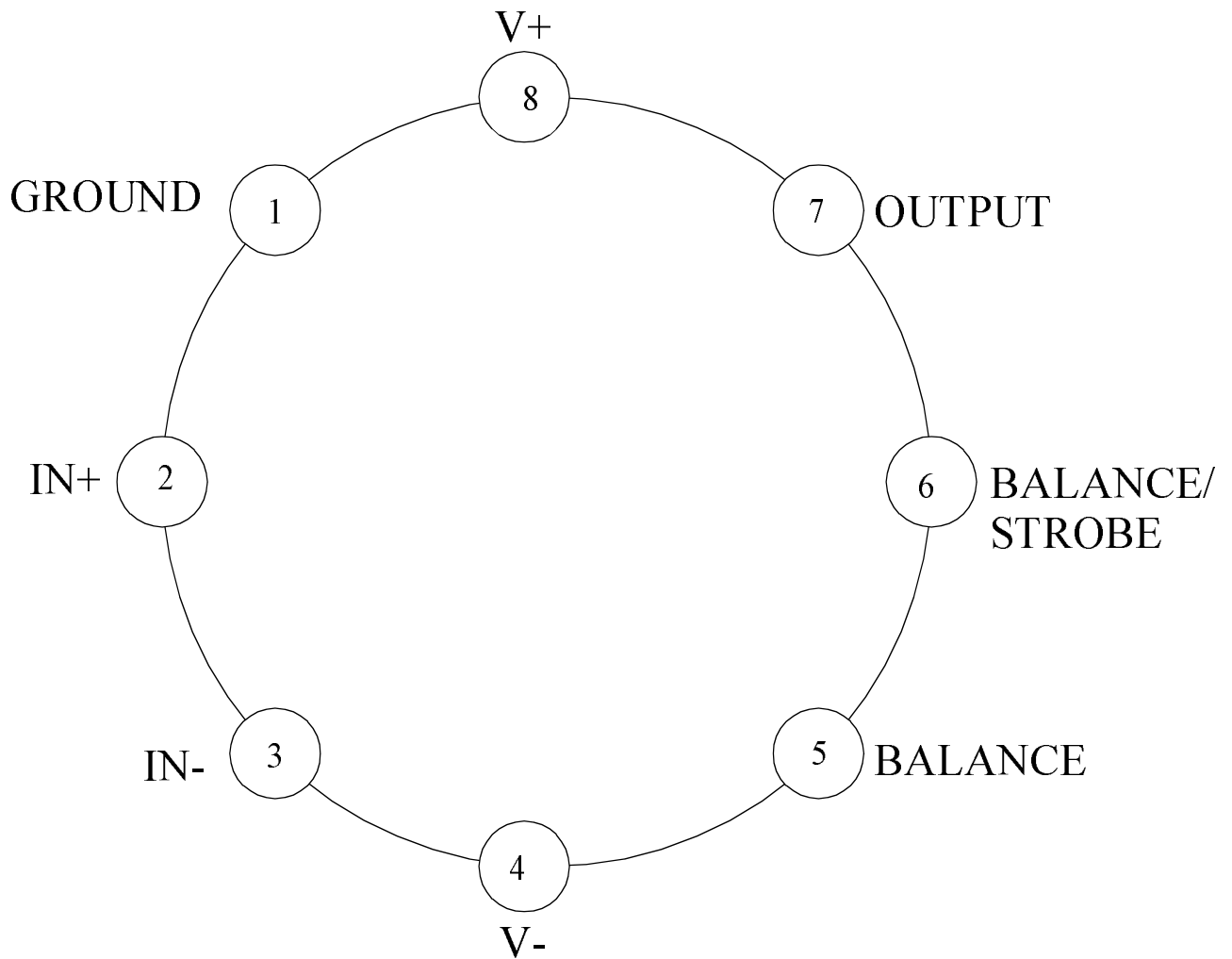

LM111H  
8 - PIN METAL CAN  
CONNECTION DIAGRAM  
TOP VIEW  
P000264A

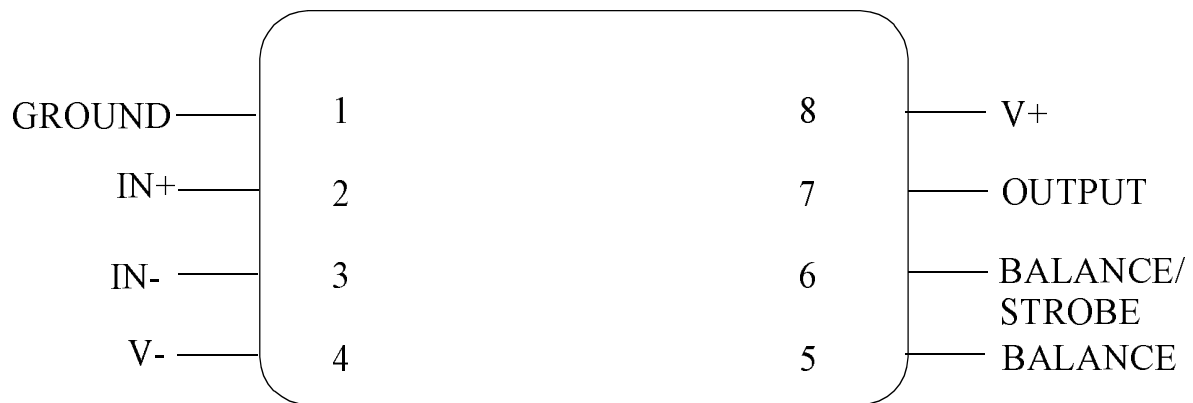

LM111J-8  
8 - LEAD DIP  
CONNECTION DIAGRAM  
TOP VIEW  
P000265A



National Semiconductor™  
MIL/AEROSPACE OPERATIONS  
2900 SEMICONDUCTOR DRIVE  
SANTA CLARA, CA 95050

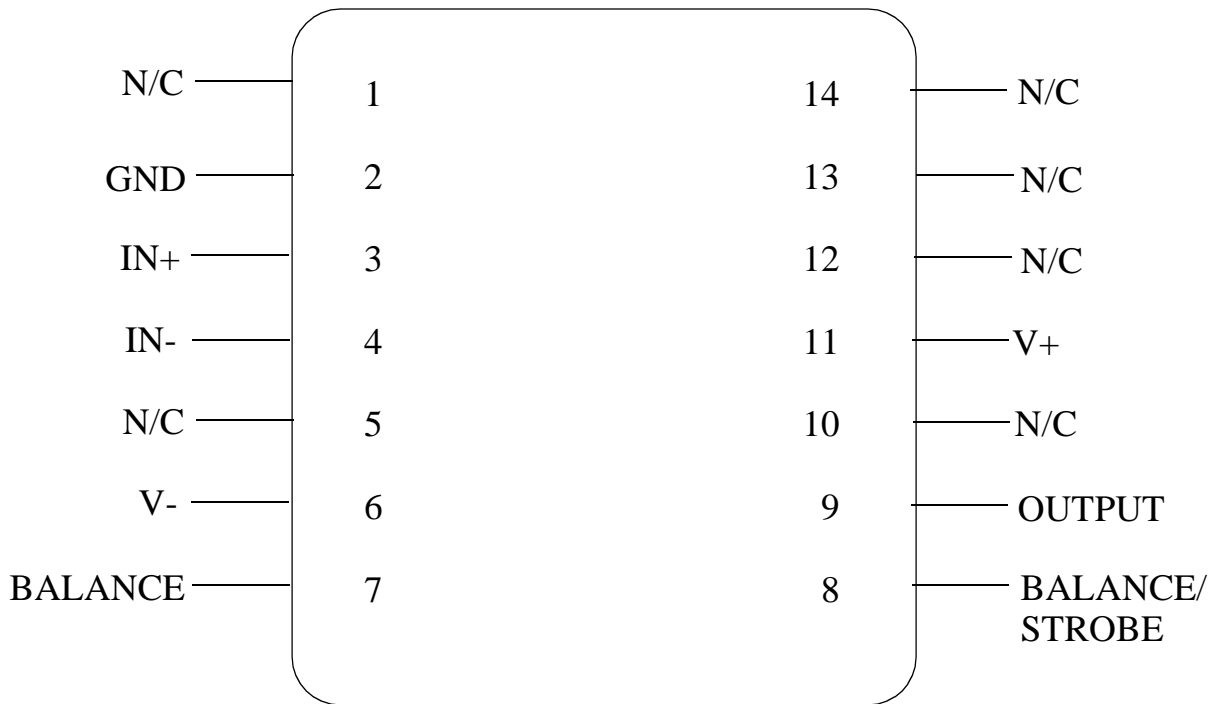

**LM111J**  
**14 - LEAD DIP**  
**CONNECTION DIAGRAM**  
**TOP VIEW**  
**P000266A**



National Semiconductor™

MIL/AEROSPACE OPERATIONS  
 2900 SEMICONDUCTOR DRIVE  
 SANTA CLARA, CA 95050

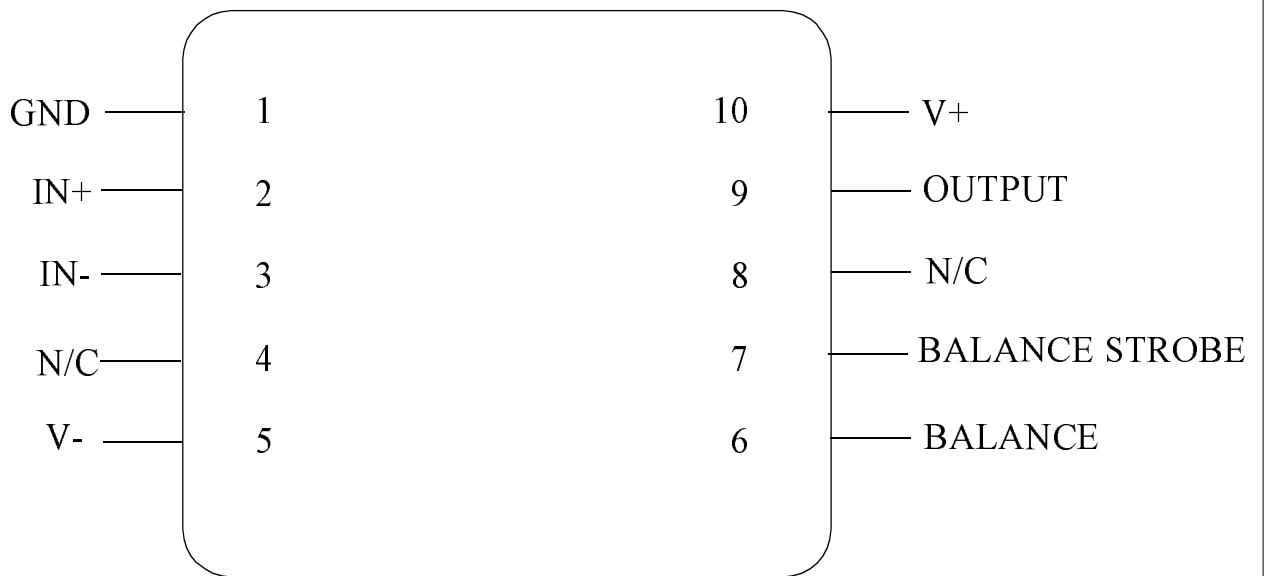

LM111W  
10 - LEAD CERPACK  
CONNECTION DIAGRAM  
TOP VIEW  
P000267A



National Semiconductor™

MIL/AEROSPACE OPERATIONS  
2900 SEMICONDUCTOR DRIVE  
SANTA CLARA, CA 95050



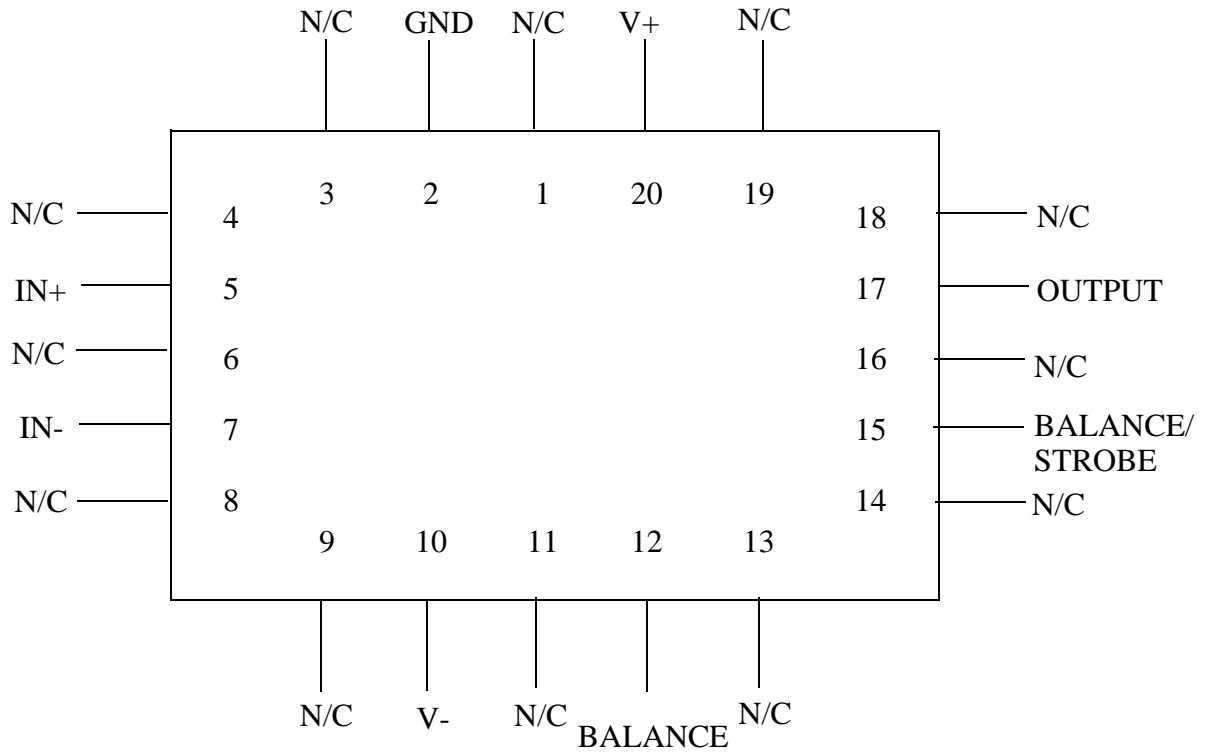

**LM111E**  
**20 - LEAD LCC**  
**CONNECTION DIAGRAM**  
**TOP VIEW**  
**P000314B**

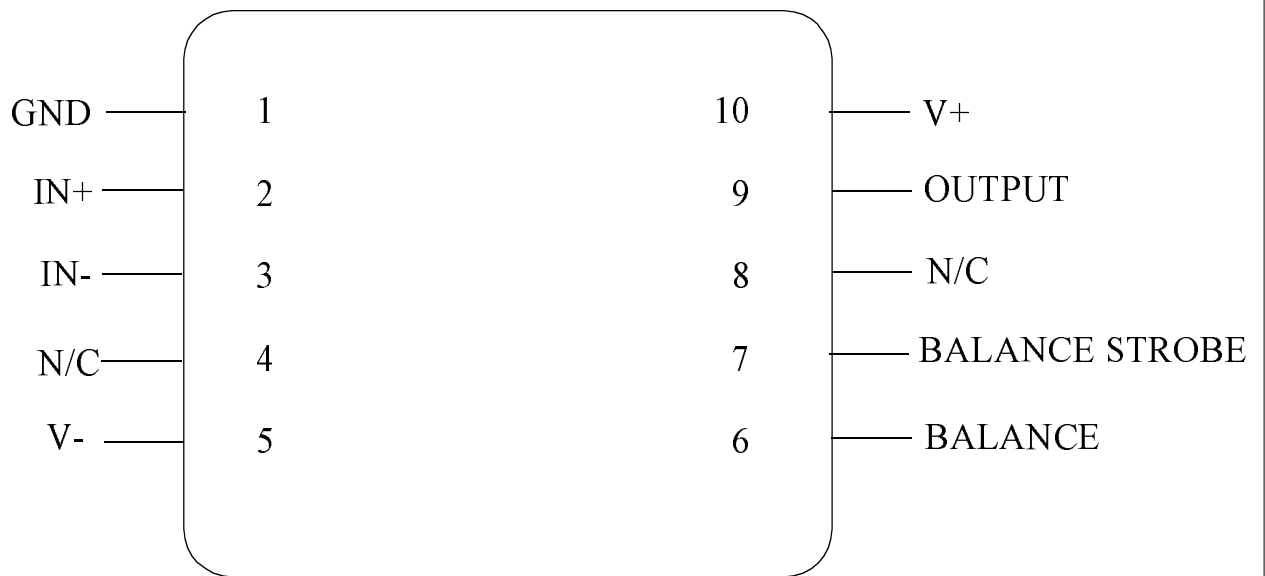

LM111WG  
10 - LEAD CERAMIC SOIC  
CONNECTION DIAGRAM  
TOP VIEW  
P000373A



National Semiconductor™  
MIL/AEROSPACE OPERATIONS  
2900 SEMICONDUCTOR DRIVE  
SANTA CLARA, CA 95050

REVISIONS			
LTR	DESCRIPTION	E.C.N.	DATE
F	REVISE AND REDRAW PER NEW STANDARD.	10510	07/28/94 DEG/AEP
G	.017±.002 WAS .017±.020.	10654	10/21/94 DEG/

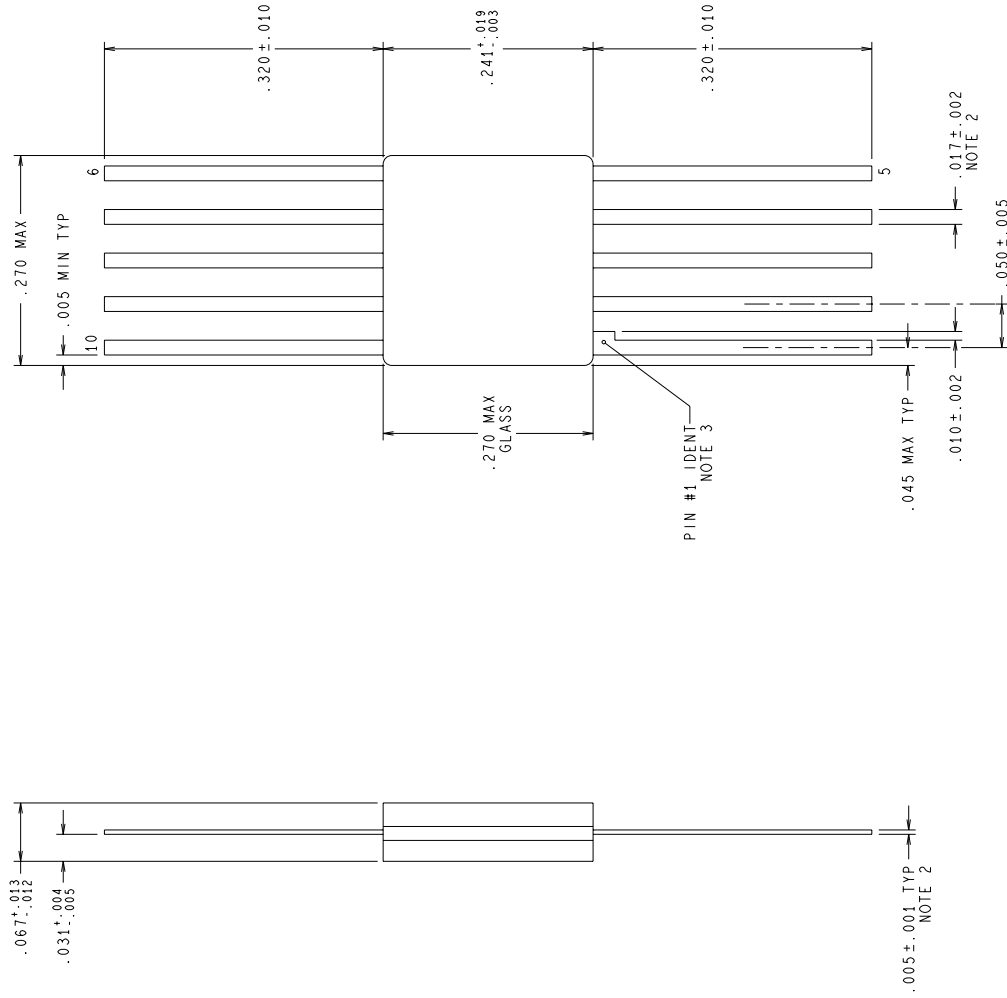

NOTES: UNLESS OTHERWISE SPECIFIED.

1. LEAD FINISH: SOLDER DIPPED WITH Sn60 OR Sn63 SOLDER CONFORMING TO MIL-M-38510 TO A MINIMUM THICKNESS OF 200 MICRONS. SOLDER MAY BE APPLIED OVER LEAD BASIS METAL OR Sn PLATE.
2. MAXIMUM LIMIT MAY BE INCREASED BY .003 INCHES AFTER LEAD FINISH APPLIED.
3. LEAD 1 IDENTIFICATION SHALL BE:
  - a) A NOTCH OR OTHER MARK WITHIN THIS AREA
  - b) A TAB ON LEAD 1, EITHER SIDE
4. REFERENCE JEDEC REGISTRATION M0-003, VARIATION AG, DATED 06/01/76.

MIL/AERO  
CONFIGURATION CONTROL

MIL-M-38510  
CONFIGURATION CONTROL

APPROVALS		DATE	
DRWN	<i>D. F. Grady</i>		07/28/94
DTG. CHK.			
ENGR. CHK.			

PROJECTION			
1 INCH			

National Semiconductor			
2800 Semiconductor dr., Santa Clara, CA 95052-8090			
SCALE	N/A	SIZE	C
DRAWING NUMBER	MKT-W10A		
REV	G		
CERPACK, 10 LEAD			
DO NOT SCALE DRAWING		SHEET 1 of 1	

REVISIONS

LTR	DESCRIPTION	E.C.N.	DATE	BY/APP'D
A	RELEASE TO DOCUMENT CONTROL	11374	02/29/1996	MS/KH
B	LD PITCH TOL WAS ±.005; CHANGE LD RADIUS TO REF DIM; REMOVE THE OTHER R.006±.002 DIM. .040±.003 WAS .037±.003	11441	04/19/1996	MS/KH
C	R .015(0.38) WAS R .006(0.15)	11838	10/08/1997	TL/

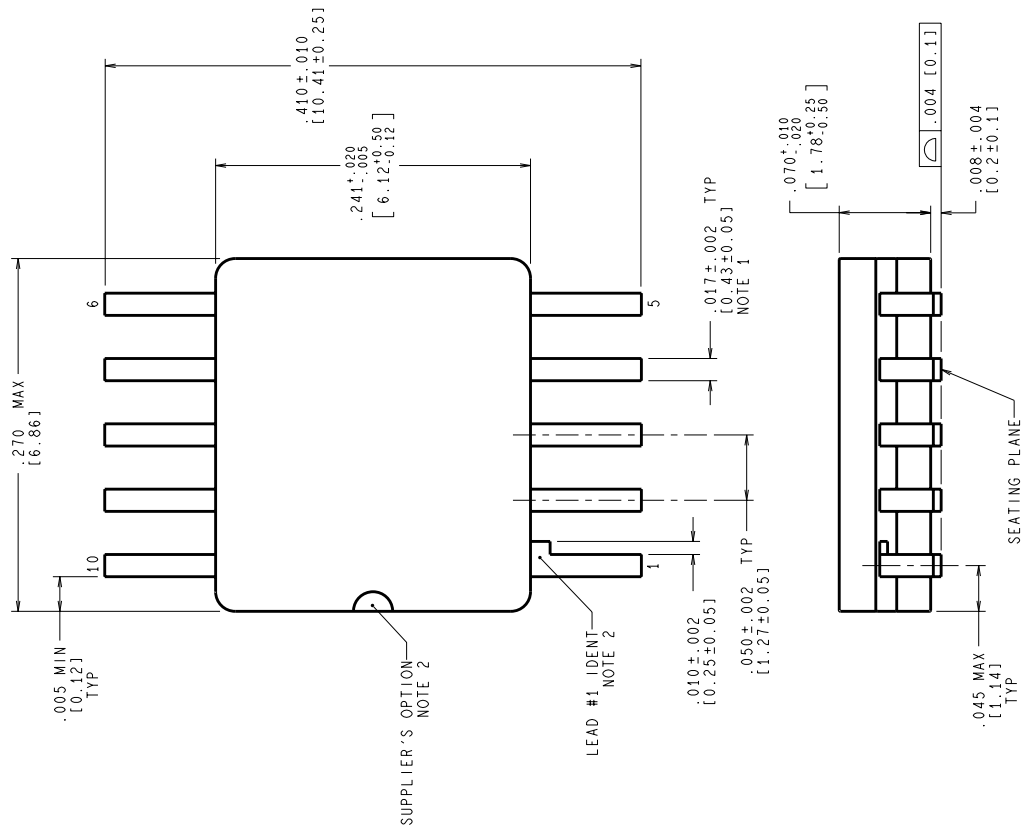

CONTROLLING DIMENSION IS INCH  
VALUES IN | ARE MILLIMETERS

MIL-PRF-38535  
CONFIGURATION CONTROL

APPROVALS	DATE	SCALE	SIZE	DRAWING NUMBER	REV
DRN: MARYA SUCHY	02/29/96	N/A	C	(SC)MKT-WG10A	C
DATE: 02/29/96					
ENGR. CHK.					
PROJECTION					
NATIONAL SEMICONDUCTOR 2800 Semiconductor Dr., Santa Clara, CA 95052-8090					
<b>CERPACK, 10 LEAD, GULL WING</b>					
DO NOT SCALE DRAWING SHEET 1 of 1					

- NOTES: UNLESS OTHERWISE SPECIFIED
- LEAD FINISH: SOLDER DIPPED WITH Sn60 OR Sn63 SOLDER CONFORMING TO MIL-PRF-38535 TO A MINIMUM THICKNESS OF 200 MICRONS/ 5.08 MICROMETERS. SOLDER MAY BE APPLIED OVER LEAD BASIS METAL OR Sn PLATE. MAXIMUM LIMIT MAY BE INCREASED BY .003 IN/ 0.08mm AFTER LEAD FINISH APPLIED.
  - LEAD 1 IDENTIFICATION SHALL BE:
    - A NOTCH OR OTHER MARK WITHIN THIS AREA
    - A TAB ON LEAD 1, EITHER SIDE
  - NO JEDEC REGISTRATION AS OF FEBRUARY 1996.