

Product Preview
Unbuffered Inverter

MC74VHC1GU04

The MC74VHC1GU04 is an advanced high speed CMOS Unbuffered inverter fabricated with silicon gate CMOS technology. It achieves high speed operation similar to equivalent Bipolar Schottky TTL while maintaining CMOS low power dissipation.

This device consists of a single unbuffered inverter. In combination with others, or in the MC74VHCU04 Hex Unbuffered Inverter, these devices are well suited for use as oscillators, pulse shapers, and in many other applications requiring a high-input impedance amplifier. For digital applications, the MC74VHC1G04 or the MC74VHC04 are recommended.

The internal circuit is composed of three stages, including a buffer output which provides high noise immunity and stable output.

The MC74VHC1GU04 input structure provides protection when voltages up to 7V are applied, regardless of the supply voltage. This allows the MC74VHC1GU04 to be used to interface 5V circuits to 3V circuits.

- High Speed: $t_{PD} = 3.5ns$ (Typ) at $V_{CC} = 5V$
- Low Power Dissipation: $I_{CC} = 2\mu A$ (Max) at $T_A = 25^\circ C$
- Power Down Protection Provided on Inputs
- Balanced Propagation Delays
- Pin and Function Compatible with Other Standard Logic Families
- Latchup Performance Exceeds 300mA
- ESD Performance: HBM > 2000V; MM > 200V, CDM > 1500V
- Chip Complexity: 2 FETs or 1 Equivalent Gates



FUNCTION TABLE

A Input	\bar{Y} Output
L	H
H	L

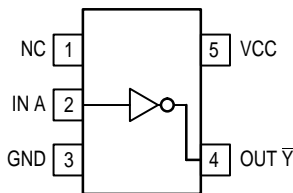

Figure 1. 5-Lead SOT-353 Pinout (Top View)

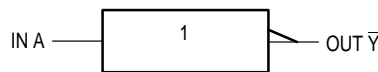
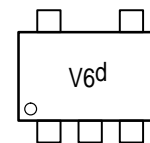

Figure 2. Logic Symbol



Pin 1
d = Date Code

Marking Diagram

DEVICE ORDERING INFORMATION

Device Order Number	Device Nomenclature						Package Type	Tape and Reel Size
	Motorola Circuit Indicator	Temp Range Identifier	Technology	Device Function	Package Suffix	Tape and Reel Suffix		
MC74VHC1GU04DFT1	MC	74	VHC1G	U04	DF	T1	SC-88A	7-Inch/3000 Unit

This document contains information on a product under development. Motorola reserves the right to change or discontinue this product without notice.

MAXIMUM RATINGS*

Characteristics	Symbol	Value	Unit
DC Supply Voltage	V_{CC}	-0.5 to +7.0	V
DC Input Voltage	V_{IN}	-0.5 to +7.0	V
DC Output Voltage	V_{OUT}	-0.5 to 7.0 -0.5 to $V_{CC} + 0.5$	V
Input Diode Current	I_{IK}	-20	mA
Output Diode Current	I_{OK}	+20	mA
DC Output Current, per Pin	I_{OUT}	+25	mA
DC Supply Current, V_{CC} and GND	I_{CC}	+50	mA
Power dissipation in still air, SC-88A †	P_D	200	mW
Lead temperature, 1 mm from case for 10 s	T_L	260	°C
Storage temperature	T_{stg}	-65 to +150	°C

* Maximum Ratings are those values beyond which damage to the device may occur. Exposure to these conditions or conditions beyond those indicated may adversely affect device reliability. Functional operation under absolute-maximum-rated conditions is not implied. Functional operation should be restricted to the Recommended Operating Conditions.

† Derating — SC-88A Package: -5 mW/°C from 65° to 125°C

RECOMMENDED OPERATING CONDITIONS

Characteristics	Symbol	Min	Max	Unit
DC Supply Voltage	V_{CC}	2.0	5.5	V
DC Input Voltage	V_{IN}	0.0	5.5	V
DC Output Voltage	V_{OUT}	0.0	V_{CC}	V
Operating Temperature Range	T_A	-55	+125	°C
Input Rise and Fall Time	t_r, t_f	0	No Limit	ns/V
		0	No Limit	

DC ELECTRICAL CHARACTERISTICS

Symbol	Parameter	Test Conditions	V _{CC} (V)	T _A = 25°C			T _A ≤ 85°C		T _A ≤ 125°C		Unit
				Min	Typ	Max	Min	Max	Min	Max	
V _{IH}	Minimum High-Level Input Voltage		2.0	1.7			1.7		1.7		V
			3.0	2.4			2.4		2.4		
			4.5	3.6			3.6		3.6		
			5.5	4.4			4.4		4.4		
V _{IL}	Maximum Low-Level Input Voltage		2.0			0.3		0.3		0.3	V
			3.0			0.6		0.6		0.6	
			4.5			0.9		0.9		0.9	
			5.5			1.1		1.1		1.1	
V _{OH}	Minimum High-Level Output Voltage V _{IN} = V _{IH} or V _{IL}	V _{IN} = V _{IH} or V _{IL} I _{OH} = -50μA	2.0	1.9	2.0		1.9		1.9		V
		3.0	2.9	3.0		2.9		2.9			
		4.5	4.4	4.5		4.4		4.4		4.4	
		V _{IN} = V _{IH} or V _{IL} I _{OH} = -4mA	3.0	2.58			2.48		2.34		V
4.5	3.94			3.80		3.66					
V _{OL}	Maximum Low-Level Output Voltage V _{IN} = V _{IH} or V _{IL}	V _{IN} = V _{IH} or V _{IL} I _{OL} = 50μA	2.0		0.0	0.1		0.1		0.1	V
		3.0		0.0	0.1		0.1		0.1		
		4.5		0.0	0.1		0.1		0.1		
		V _{IN} = V _{IH} or V _{IL} I _{OL} = 4mA	3.0			0.36		0.44		0.52	V
4.5			0.36		0.44		0.52				
I _{IN}	Maximum Input Leakage Current	V _{IN} = 5.5V or GND	0 to 5.5			±0.1		±1.0		μA	
I _{CC}	Maximum Quiescent Supply Current	V _{IN} = V _{CC} or GND	5.5			2.0		20		40	μA

AC ELECTRICAL CHARACTERISTICS (C_{load} = 50 pF, Input t_r = t_f = 3.0ns)

Symbol	Parameter	Test Conditions	T _A = 25°C			T _A ≤ 85°C		T _A ≤ 125°C		Unit
			Min	Typ	Max	Min	Max	Min	Max	
t _{PLH} , t _{PHL}	Maximum Propagation Delay, Input A to \bar{Y}	V _{CC} = 3.0 ± 0.3V C _L = 15 pF		5.0	8.9		10.5		12.0	ns
		C _L = 50 pF		7.5	11.4		13.0		15.5	
		V _{CC} = 5.0 ± 0.5V C _L = 15 pF		3.5	5.5		6.5		8.0	
		C _L = 50 pF		5.0	7.0		8.0		9.5	
C _{IN}	Maximum Input Capacitance			4	10		10		10	pF

C _{PD}	Power Dissipation Capacitance (Note 1.)	Typical @ 25°C, V _{CC} = 5.0V	pF
		15	

1. C_{PD} is defined as the value of the internal equivalent capacitance which is calculated from the operating current consumption without load. Average operating current can be obtained by the equation: I_{CC(OPR)} = C_{PD} • V_{CC} • f_{in} + I_{CC}. C_{PD} is used to determine the no-load dynamic power consumption; P_D = C_{PD} • V_{CC}² • f_{in} + I_{CC} • V_{CC}.

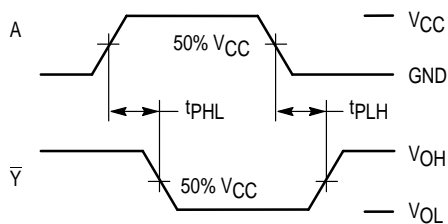
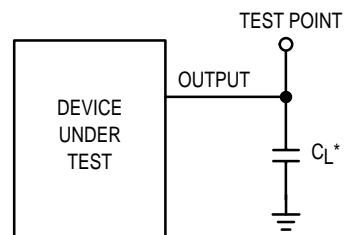

Figure 3. Switching Waveforms



* Includes all probe and jig capacitance

Figure 4. Test Circuit

OUTLINE DIMENSIONS

DF SUFFIX
5-LEAD SOT-353 PACKAGE
SC-88A
CASE 419A-01
ISSUE B

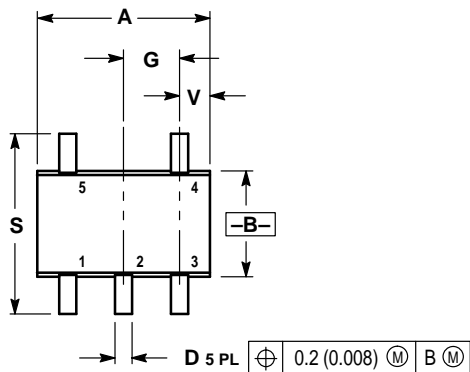

- NOTES:
1. DIMENSIONING AND TOLERANCING PER ANSI Y14.5M, 1982.
2. CONTROLLING DIMENSION: MM.

DIM	INCHES		MILLIMETERS	
	MIN	MAX	MIN	MAX
A	0.071	0.087	1.80	2.20
B	0.045	0.053	1.15	1.35
C	0.031	0.043	0.80	1.10
D	0.004	0.012	0.10	0.30
G	0.026 BSC		0.65 BSC	
H	—	0.004	—	0.10
J	0.004	0.010	0.10	0.25
K	0.004	0.012	0.10	0.30
N	0.008 REF		0.20 REF	
S	0.079	0.087	2.00	2.20
V	0.012	0.016	0.30	0.40

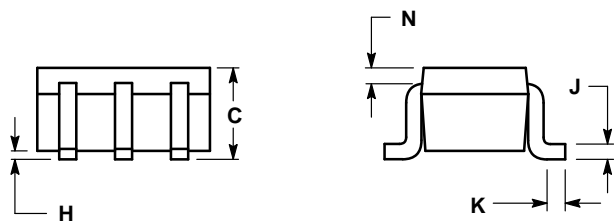

SOT-353

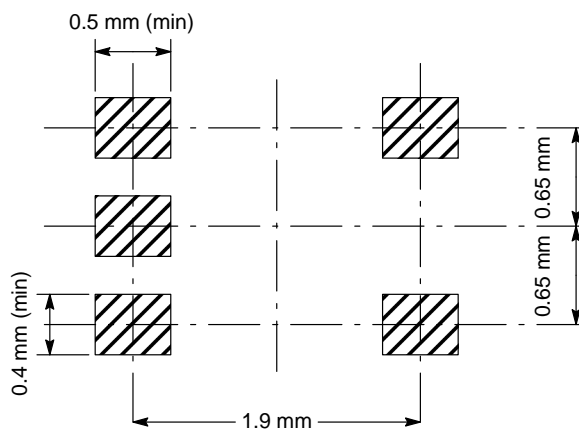

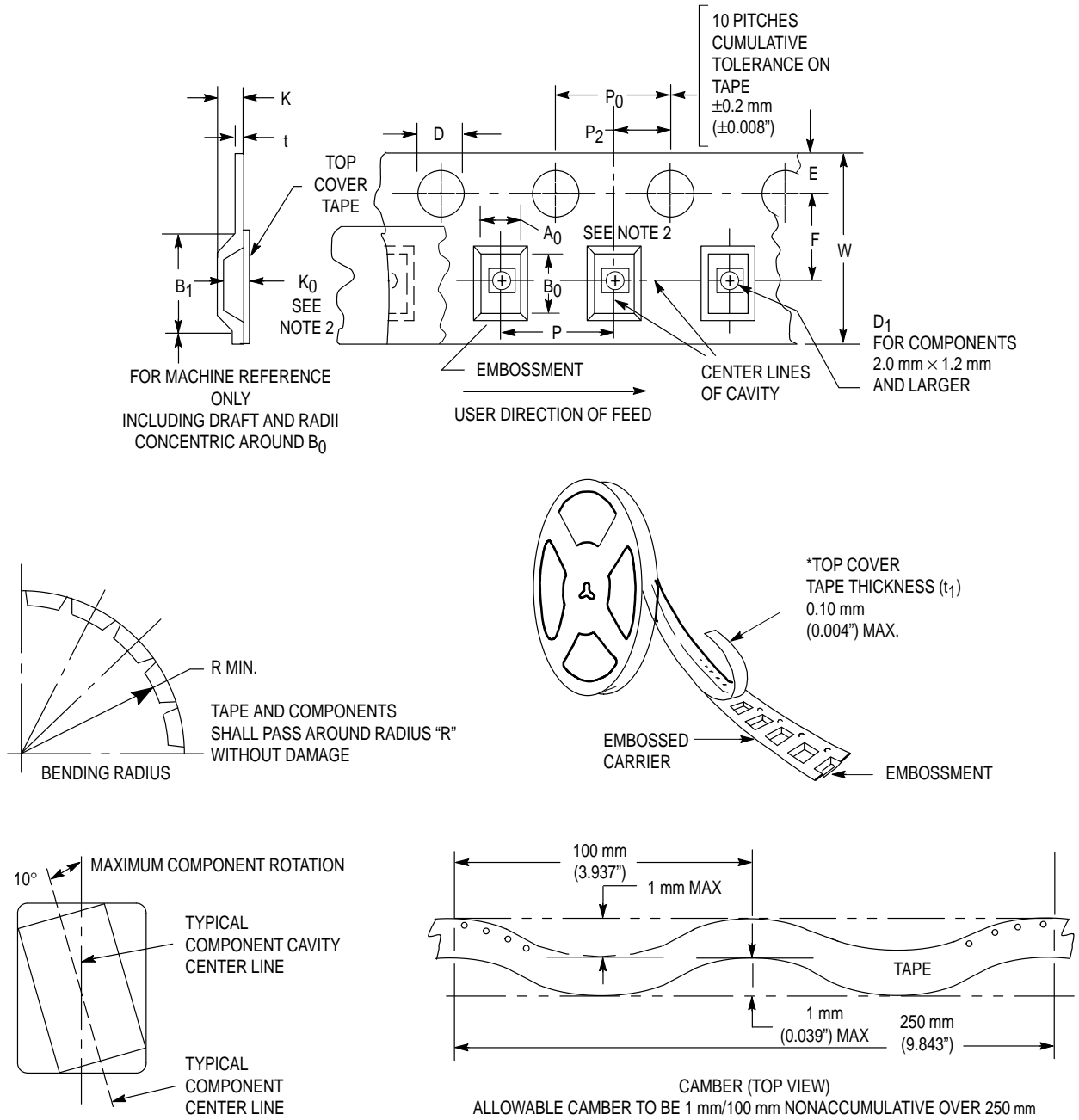

Figure 5. Carrier Tape Specifications

EMBOSSED CARRIER DIMENSIONS (See Notes 1 and 2)

Tape Size	B_1 Max	D	D_1	E	F	K	P	P_0	P_2	R	T	W
8 mm	4.35 mm (0.171")	1.5 +0.1/-0.0 mm (0.059 +0.004/-0.0")	1.0 mm Min (0.039")	1.75 ± 0.1 mm (0.069 ± 0.004 ")	3.5 ± 0.5 mm (1.38 ± 0.002 ")	2.4 mm (0.094")	4.0 ± 0.10 mm (0.157 ± 0.004 ")	4.0 ± 0.1 mm (0.156 ± 0.004 ")	2.0 ± 0.1 mm (0.079 ± 0.002 ")	25 mm (0.98")	0.3 ± 0.05 mm (0.01 $\pm 0.0038/-0.0002$ ")	8.0 ± 0.3 mm (0.315 ± 0.012 ")

- Metric Dimensions Govern—English are in parentheses for reference only.
- A_0 , B_0 , and K_0 are determined by component size. The clearance between the components and the cavity must be within 0.05 mm min to 0.50 mm max. The component cannot rotate more than 10° within the determined cavity

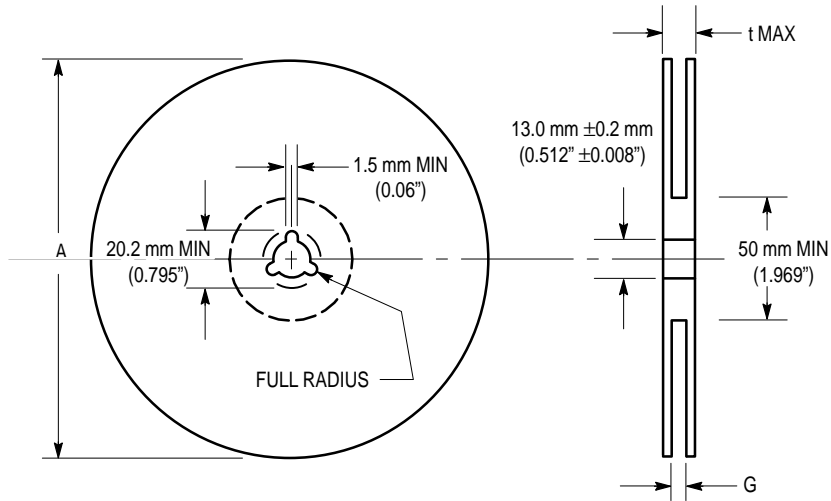

Figure 6. Reel Dimensions

REEL DIMENSIONS

Tape Size	A Max	G	t Max
8 mm	330 mm (13")	8.400 mm, +1.5 mm, -0.0 (0.33", +0.059", -0.00)	14.4 mm (0.56")

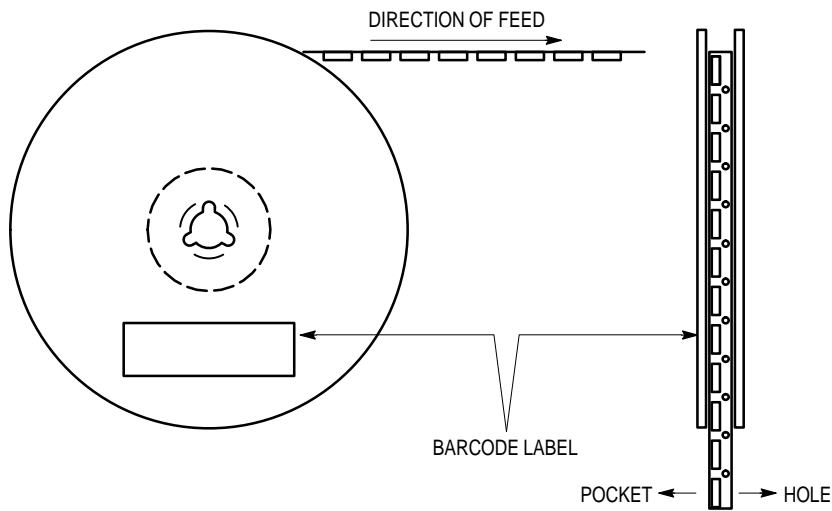

Figure 7. Reel Winding Direction

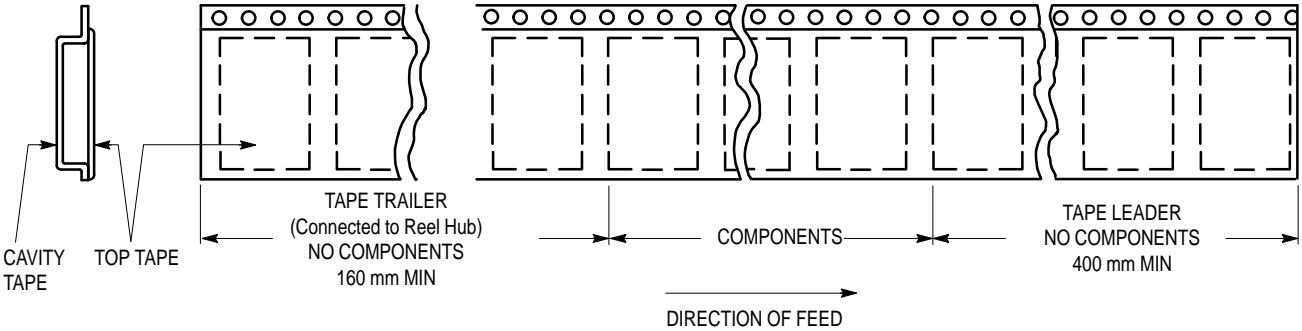

Figure 8. Tape Ends for Finished Goods

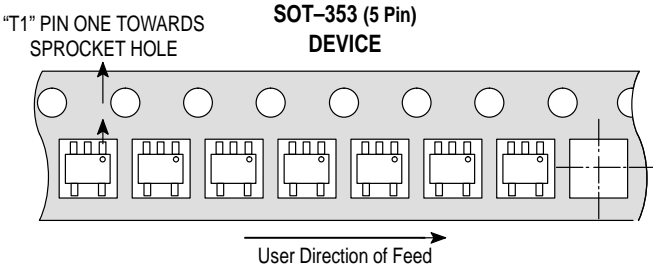



Figure 9. Reel Configuration

Motorola reserves the right to make changes without further notice to any products herein. Motorola makes no warranty, representation or guarantee regarding the suitability of its products for any particular purpose, nor does Motorola assume any liability arising out of the application or use of any product or circuit, and specifically disclaims any and all liability, including without limitation consequential or incidental damages. "Typical" parameters which may be provided in Motorola data sheets and/or specifications can and do vary in different applications and actual performance may vary over time. All operating parameters, including "Typicals" must be validated for each customer application by customer's technical experts. Motorola does not convey any license under its patent rights nor the rights of others. Motorola products are not designed, intended, or authorized for use as components in systems intended for surgical implant into the body, or other applications intended to support or sustain life, or for any other application in which the failure of the Motorola product could create a situation where personal injury or death may occur. Should Buyer purchase or use Motorola products for any such unintended or unauthorized application, Buyer shall indemnify and hold Motorola and its officers, employees, subsidiaries, affiliates, and distributors harmless against all claims, costs, damages, and expenses, and reasonable attorney fees arising out of, directly or indirectly, any claim of personal injury or death associated with such unintended or unauthorized use, even if such claim alleges that Motorola was negligent regarding the design or manufacture of the part. Motorola and  are registered trademarks of Motorola, Inc. Motorola, Inc. is an Equal Opportunity/Affirmative Action Employer.

Mfax is a trademark of Motorola, Inc.

How to reach us:

USA/EUROPE/Locations Not Listed: Motorola Literature Distribution;
P.O. Box 5405, Denver, Colorado 80217. 1-303-675-2140 or 1-800-441-2447

JAPAN: Nippon Motorola Ltd.; SPD, Strategic Planning Office, 141,
4-32-1 Nishi-Gotanda, Shinagawa-ku, Tokyo, Japan. 81-3-5487-8488

Customer Focus Center: 1-800-521-6274

Mfax™: RMFAX0@email.sps.mot.com – TOUCHTONE 1-602-244-6609
Motorola Fax Back System – US & Canada ONLY 1-800-774-1848
– <http://sps.motorola.com/mfax/>

ASIA/PACIFIC: Motorola Semiconductors H.K. Ltd.; 8B Tai Ping Industrial Park,
51 Ting Kok Road, Tai Po, N.T., Hong Kong. 852-26629298

HOME PAGE: <http://motorola.com/sps/>

