

Designer's™ Data Sheet
Power Field Effect Transistor
P-Channel Enhancement-Mode Silicon Gate

MTP12P10

This TMOS Power FET is designed for medium voltage, high speed power switching applications such as switching regulators, converters, solenoid and relay drivers.

- Silicon Gate for Fast Switching Speeds — Switching Times Specified at 100°C
- Designer's Data — I_{DSS} , $V_{DS(on)}$, $V_{GS(th)}$ and SOA Specified at Elevated Temperature
- Rugged — SOA is Power Dissipation Limited
- Source-to-Drain Diode Characterized for Use With Inductive Loads



TMOS POWER FET
12 AMPERES
100 VOLTS
 $R_{DS(on)} = 0.3 \text{ OHM}$

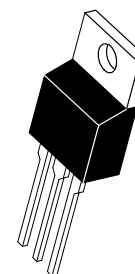
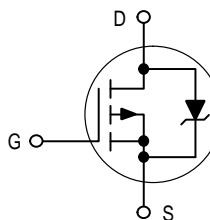

CASE 221A-06, Style 5
TO-220AB

MAXIMUM RATINGS ($T_C = 25^\circ\text{C}$ unless otherwise noted)

| Rating | Symbol | Value | Unit |
|--|-----------------------|----------------------|---------------|
| Drain-Source Voltage | V_{DSS} | 100 | Vdc |
| Drain-Gate Voltage ($R_{GS} = 1.0 \text{ M}\Omega$) | V_{DGR} | 100 | Vdc |
| Gate-Source Voltage — Continuous — Non-repetitive ($t_p \leq 50 \mu\text{s}$) | V_{GS} V_{GSM} | ± 20 ± 40 | Vdc Vpk |
| Drain Current — Continuous — Pulsed | I_D I_{DM} | 12 28 | Adc |
| Total Power Dissipation Derate above 25°C | P_D | 75 0.6 | Watts W/°C |
| Operating and Storage Temperature Range | T_J, T_{stg} | -65 to 150 | °C |

THERMAL CHARACTERISTICS

| | | | |
|--|------------------------------------|--------------|------|
| Thermal Resistance — Junction to Case — Junction to Ambient | $R_{\theta JC}$ $R_{\theta JA}$ | 1.67 62.5 | °C/W |
| Maximum Lead Temperature for Soldering Purposes, 1/8" from case for 10 seconds | T_L | 260 | °C |

Designer's Data for "Worst Case" Conditions — The Designer's Data Sheet permits the design of most circuits entirely from the information presented. SOA Limit curves — representing boundaries on device characteristics — are given to facilitate "worst case" design.

Designer's is a trademark of Motorola, Inc.

REV 1

MTP12P10

ELECTRICAL CHARACTERISTICS (T_J = 25°C unless otherwise noted)

| Characteristic | Symbol | Min | Max | Unit | |
|---|---|------------------------|-----------------------------|------|-----|
| OFF CHARACTERISTICS | | | | | |
| Drain–Source Breakdown Voltage (V _{GS} = 0, I _D = 0.25 mA) | V _{(BR)DSS} | 100 | — | Vdc | |
| Zero Gate Voltage Drain Current (V _{DS} = Rated V _{DSS} , V _{GS} = 0) (V _{DS} = Rated V _{DSS} , V _{GS} = 0, T _J = 125°C) | I _{DSS} | — — | 10 100 | μAdc | |
| Gate–Body Leakage Current, Forward (V _{GSF} = 20 Vdc, V _{DS} = 0) | I _{GSSF} | — | 100 | nAdc | |
| Gate–Body Leakage Current, Reverse (V _{GSR} = 20 Vdc, V _{DS} = 0) | I _{GSSR} | — | 100 | nAdc | |
| ON CHARACTERISTICS* | | | | | |
| Gate Threshold Voltage (V _{DS} = V _{GS} , I _D = 1.0 mA) T _J = 100°C | V _{GS(th)} | 2.0 1.5 | 4.5 4.0 | Vdc | |
| Static Drain–Source On–Resistance (V _{GS} = 10 Vdc, I _D = 6.0 Adc) | R _{DS(on)} | — | 0.3 | Ohm | |
| Drain–Source On–Voltage (V _{GS} = 10 V) (I _D = 12 Adc) (I _D = 6.0 Adc, T _J = 100°C) | V _{DS(on)} | — — | 4.2 3.8 | Vdc | |
| Forward Transconductance (V _{DS} = 15 V, I _D = 6.0 A) | g _{FS} | 2.0 | — | mhos | |
| DYNAMIC CHARACTERISTICS | | | | | |
| Input Capacitance | (V _{DS} = 25 V, V _{GS} = 0, f = 1.0 MHz) See Figure 10 | C _{iss} | — | 920 | pF |
| Output Capacitance | | C _{oss} | — | 575 | |
| Reverse Transfer Capacitance | | C _{rss} | — | 200 | |
| SWITCHING CHARACTERISTICS* (T_J = 100°C) | | | | | |
| Turn–On Delay Time | (V _{DD} = 25 V, I _D = 0.5 Rated I _D , R _G = 50 Ω) See Figures 12 and 13 | t _{d(on)} | — | 50 | ns |
| Rise Time | | t _r | — | 150 | |
| Turn–Off Delay Time | | t _{d(off)} | — | 150 | |
| Fall Time | | t _f | — | 150 | |
| Total Gate Charge | (V _{DS} = 0.8 Rated V _{DSS} , I _D = Rated I _D , V _{GS} = 10 V) See Figure 11 | Q _g | 33 (Typ) | 50 | nC |
| Gate–Source Charge | | Q _{gs} | 16 (Typ) | — | |
| Gate–Drain Charge | | Q _{gd} | 17 (Typ) | — | |
| SOURCE–DRAIN DIODE CHARACTERISTICS* | | | | | |
| Forward On–Voltage | (I _S = Rated I _D , V _{GS} = 0) | V _{SD} | 4.0 (Typ) | 5.5 | Vdc |
| Forward Turn–On Time | | t _{on} | Limited by stray inductance | | |
| Reverse Recovery Time | | t _{rr} | 300 (Typ) | — | ns |
| INTERNAL PACKAGE INDUCTANCE (TO–204) | | | | | |
| Internal Drain Inductance (Measured from the contact screw on the header closer to the source pin and the center of the die) | L _d | 5.0 (Typ) | — | nH | |
| Internal Source Inductance (Measured from the source pin, 0.25" from the package to the source bond pad) | L _s | 12.5 (Typ) | — | | |
| INTERNAL PACKAGE INDUCTANCE (TO–220) | | | | | |
| Internal Drain Inductance (Measured from the contact screw on tab to center of die) (Measured from the drain lead 0.25" from package to center of die) | L _d | 3.5 (Typ) 4.5 (Typ) | — — | nH | |
| Internal Source Inductance (Measured from the source lead 0.25" from package to source bond pad) | L _s | 7.5 (Typ) | — | | |

* Pulse Test: Pulse Width ≤ 300 μs, Duty Cycle ≤ 2%.

TYPICAL ELECTRICAL CHARACTERISTICS

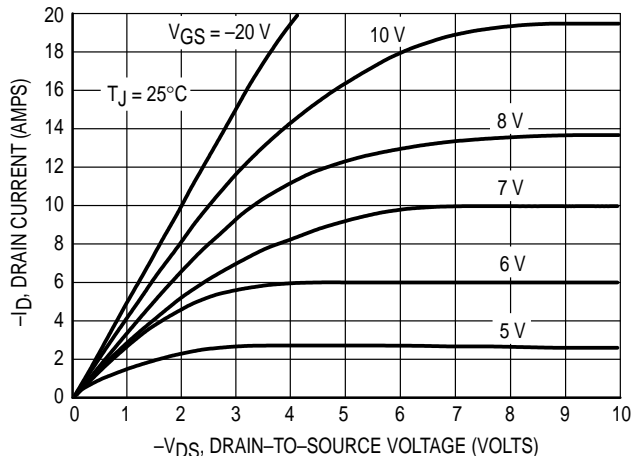

Figure 1. On-Region Characteristics

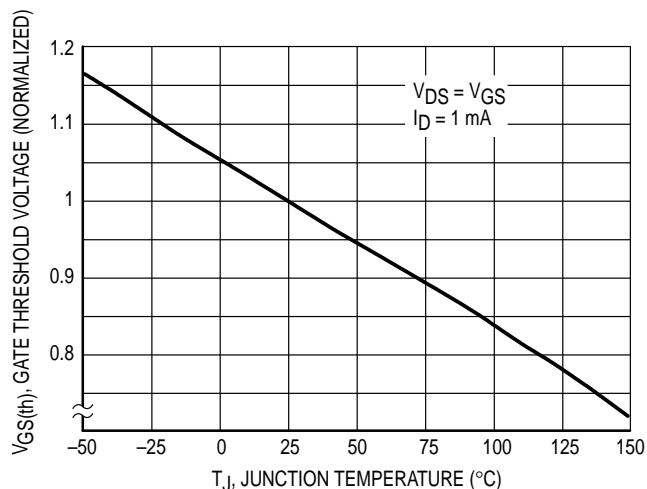

Figure 2. Gate-Threshold Voltage Variation With Temperature

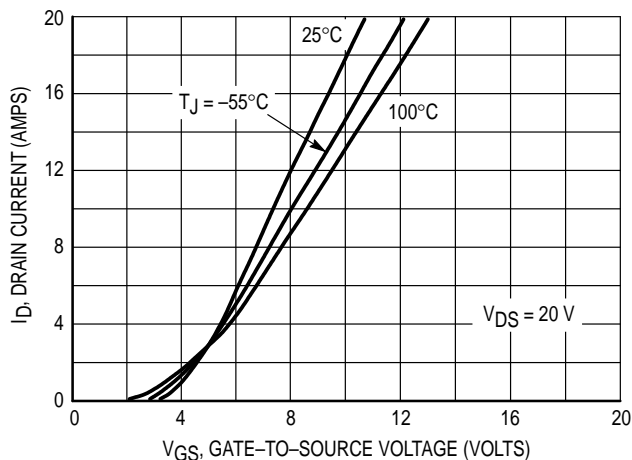

Figure 3. Transfer Characteristics

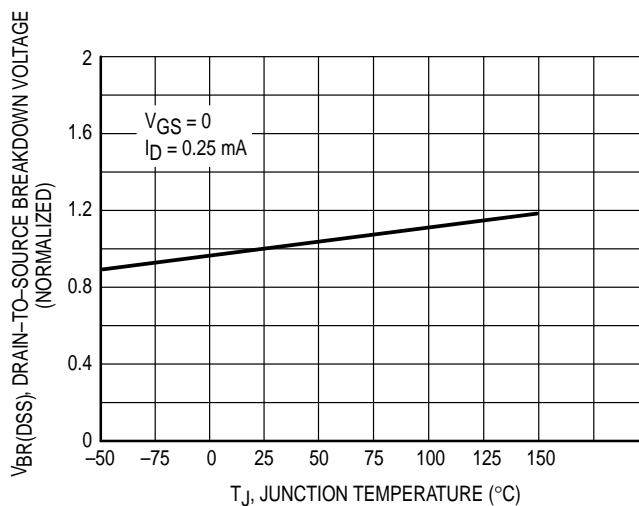

Figure 4. Normalized Breakdown Voltage versus Temperature

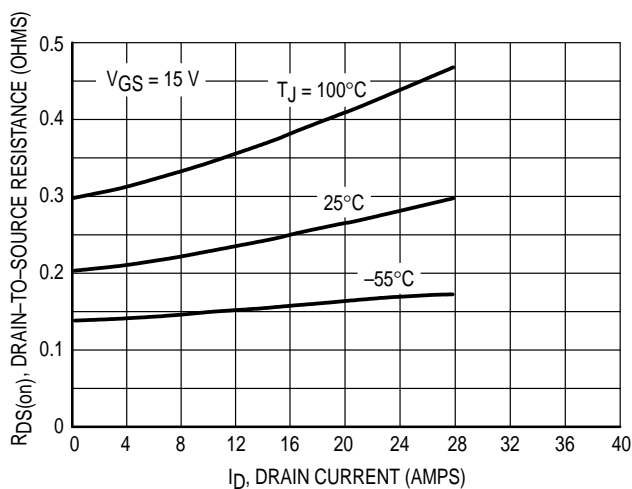

Figure 5. On-Resistance versus Drain Current

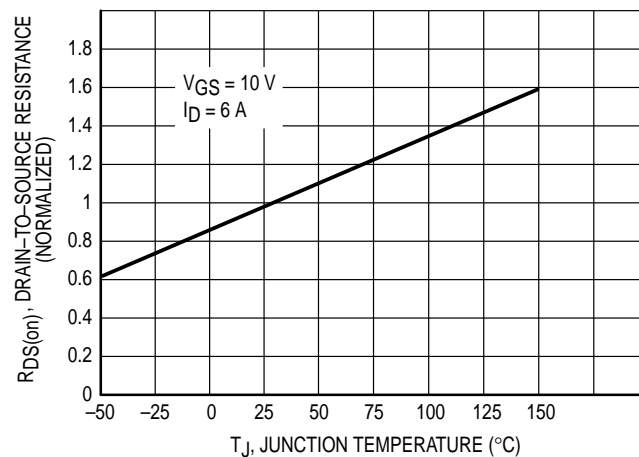

Figure 6. On-Resistance Variation With Temperature

SAFE OPERATING AREA INFORMATION

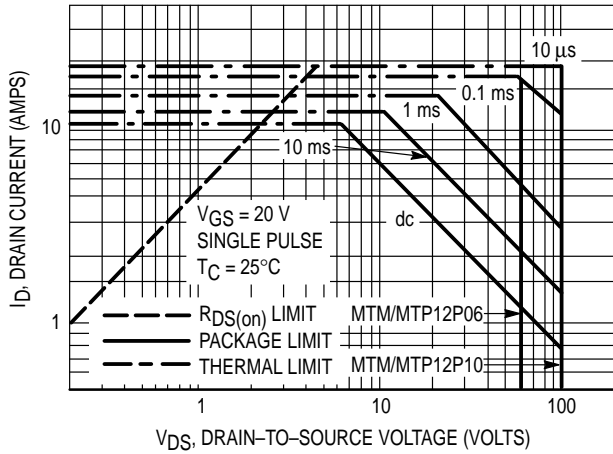

Figure 7. Maximum Rated Forward Biased Safe Operating Area

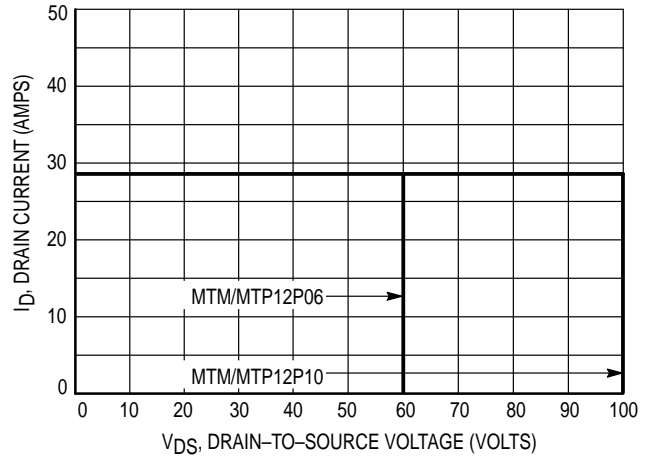

Figure 8. Maximum Rated Switching Safe Operating Area

FORWARD BIASED SAFE OPERATING AREA

The FBSOA curves define the maximum drain-to-source voltage and drain current that a device can safely handle when it is forward biased, or when it is on, or being turned on. Because these curves include the limitations of simultaneous high voltage and high current, up to the rating of the device, they are especially useful to designers of linear systems. The curves are based on a case temperature of 25°C and a maximum junction temperature of 150°C. Limitations for repetitive pulses at various case temperatures can be determined by using the thermal response curves. Motorola Application Note, AN569, "Transient Thermal Resistance—General Data and Its Use" provides detailed instructions.

SWITCHING SAFE OPERATING AREA

The switching safe operating area (SOA) of Figure 8 is the boundary that the load line may traverse without incurring damage to the MOSFET. The fundamental limits are the peak current, I_{DM} and the breakdown voltage, $V_{(BR)DSS}$. The switching SOA shown in Figure 8 is applicable for both turn-on and turn-off of the devices for switching times less than one microsecond.

The power averaged over a complete switching cycle must be less than:

$$\frac{T_J(\max) - T_C}{R_{\theta JC}}$$

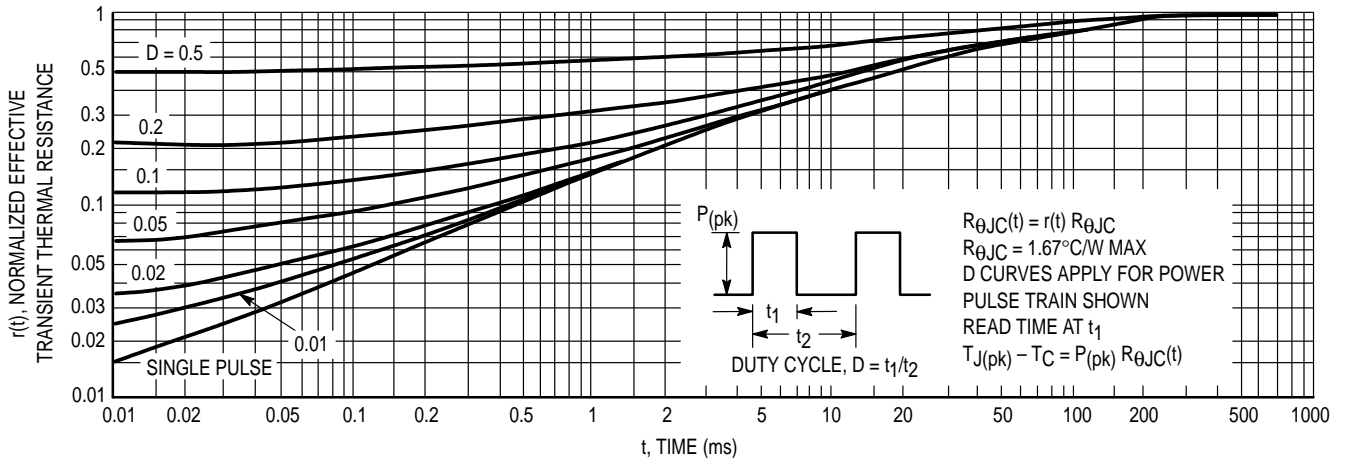

Figure 9. Thermal Response

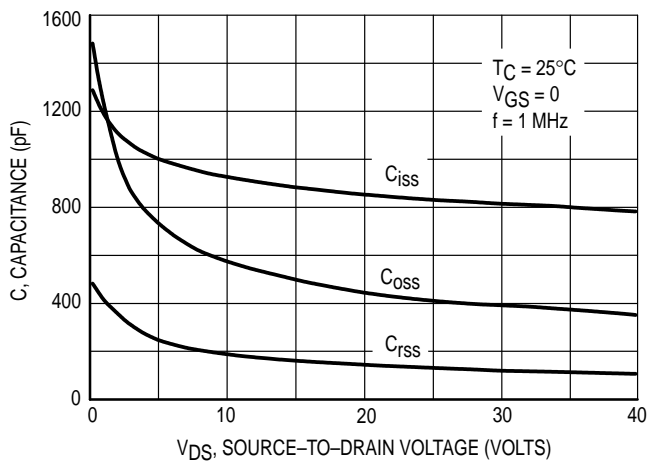

Figure 10. Capacitance Variation

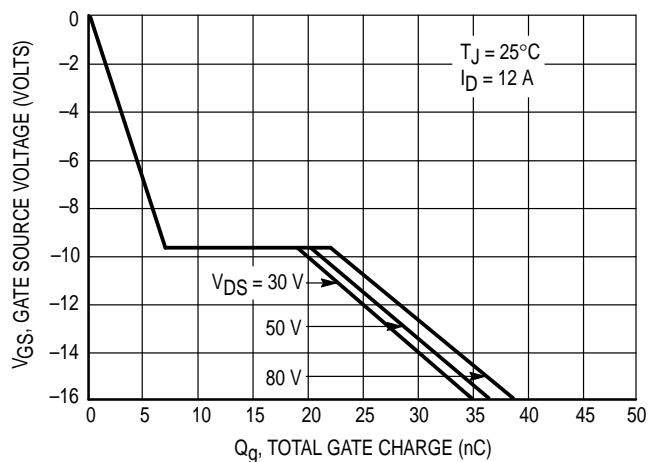

Figure 11. Gate Charge versus Gate-to-Source Voltage

RESISTIVE SWITCHING

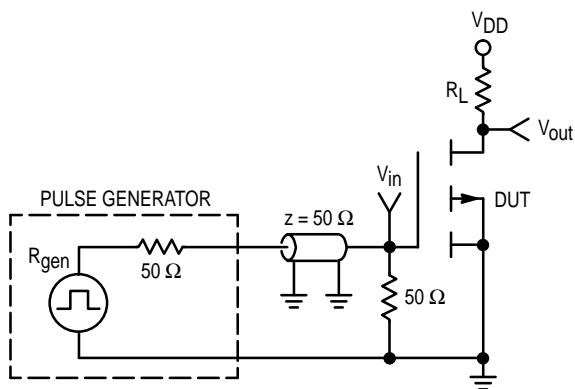

Figure 12. Switching Test Circuit

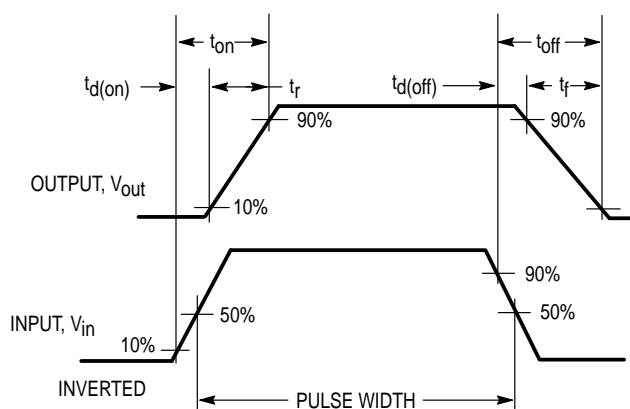
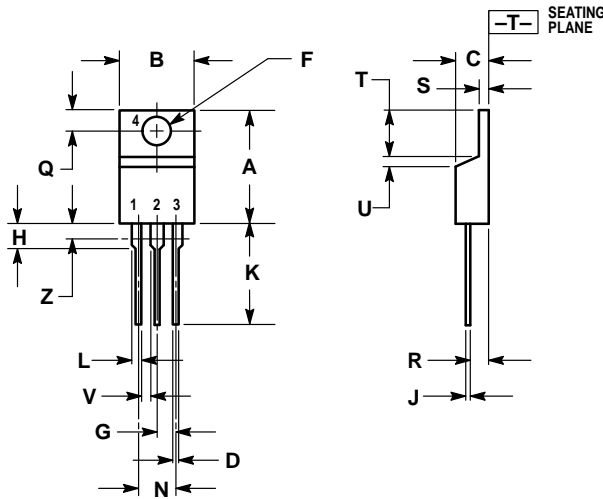

Figure 13. Switching Waveforms

PACKAGE DIMENSIONS



STYLE 5:
 PIN 1. GATE
 2. DRAIN
 3. SOURCE
 4. DRAIN

NOTES:

1. DIMENSIONING AND TOLERANCING PER ANSI Y14.5M, 1982.
2. CONTROLLING DIMENSION: INCH.
3. DIMENSION Z DEFINES A ZONE WHERE ALL BODY AND LEAD IRREGULARITIES ARE ALLOWED.

| DIM | INCHES | | MILLIMETERS | |
|-----|--------|-------|-------------|-------|
| | MIN | MAX | MIN | MAX |
| A | 0.570 | 0.620 | 14.48 | 15.75 |
| B | 0.380 | 0.405 | 9.66 | 10.28 |
| C | 0.160 | 0.190 | 4.07 | 4.82 |
| D | 0.025 | 0.035 | 0.64 | 0.88 |
| F | 0.142 | 0.147 | 3.61 | 3.73 |
| G | 0.095 | 0.105 | 2.42 | 2.66 |
| H | 0.110 | 0.155 | 2.80 | 3.93 |
| J | 0.018 | 0.025 | 0.46 | 0.64 |
| K | 0.500 | 0.562 | 12.70 | 14.27 |
| L | 0.045 | 0.060 | 1.15 | 1.52 |
| N | 0.190 | 0.210 | 4.83 | 5.33 |
| Q | 0.100 | 0.120 | 2.54 | 3.04 |
| R | 0.080 | 0.110 | 2.04 | 2.79 |
| S | 0.045 | 0.055 | 1.15 | 1.39 |
| T | 0.235 | 0.255 | 5.97 | 6.47 |
| U | 0.000 | 0.050 | 0.00 | 1.27 |
| V | 0.045 | — | 1.15 | — |
| Z | — | 0.080 | — | 2.04 |

CASE 221A-06
 ISSUE Y

Motorola reserves the right to make changes without further notice to any products herein. Motorola makes no warranty, representation or guarantee regarding the suitability of its products for any particular purpose, nor does Motorola assume any liability arising out of the application or use of any product or circuit, and specifically disclaims any and all liability, including without limitation consequential or incidental damages. "Typical" parameters can and do vary in different applications. All operating parameters, including "Typicals" must be validated for each customer application by customer's technical experts. Motorola does not convey any license under its patent rights nor the rights of others. Motorola products are not designed, intended, or authorized for use as components in systems intended for surgical implant into the body, or other applications intended to support or sustain life, or for any other application in which the failure of the Motorola product could create a situation where personal injury or death may occur. Should Buyer purchase or use Motorola products for any such unintended or unauthorized application, Buyer shall indemnify and hold Motorola and its officers, employees, subsidiaries, affiliates, and distributors harmless against all claims, costs, damages, and expenses, and reasonable attorney fees arising out of, directly or indirectly, any claim of personal injury or death associated with such unintended or unauthorized use, even if such claim alleges that Motorola was negligent regarding the design or manufacture of the part. Motorola and are registered trademarks of Motorola, Inc. Motorola, Inc. is an Equal Opportunity/Affirmative Action Employer.

How to reach us:

USA / EUROPE: Motorola Literature Distribution;
 P.O. Box 20912; Phoenix, Arizona 85036. 1-800-441-2447

JAPAN: Nippon Motorola Ltd.; Tatsumi-SPD-JLDC, Toshikatsu Otsuki,
 6F Seibu-Butsuryu-Center, 3-14-2 Tatsumi Koto-Ku, Tokyo 135, Japan. 03-3521-8315

MFAX: RMFAX0@email.sps.mot.com - TOUCHTONE (602) 244-6609
 INTERNET: http://Design-NET.com

HONG KONG: Motorola Semiconductors H.K. Ltd.; 8B Tai Ping Industrial Park,
 51 Ting Kok Road, Tai Po, N.T., Hong Kong. 852-26629298

