



SANYO Semiconductors

DATA SHEET

2SC6025 — NPN Epitaxial Planar Silicon Transistor

UHF to C Band Low-Noise Amplifier and OSC Applications

Features

- Low-noise use : NF=1.2dB typ (f=2GHz).
- High cut-off frequency : $f_T=14\text{GHz}$ typ ($V_{CE}=1\text{V}$).
- High cut-off frequency : $f_T=21\text{GHz}$ typ ($V_{CE}=3\text{V}$).
- Low operating voltage.
- High gain : $|S_{21e}|^2=12.5\text{dB}$ typ (f=2GHz).

Specifications

Absolute Maximum Ratings at $T_a=25^\circ\text{C}$

Parameter	Symbol	Conditions	Ratings	Unit
Collector-to-Base Voltage	V_{CB0}		9	V
Collector-to-Emitter Voltage	V_{CEO}		3.5	V
Emitter-to-Base Voltage	V_{EBO}		2	V
Collector Current	I_C		35	mA
Collector Dissipation	P_C		120	mW
Junction Temperature	T_J		150	$^\circ\text{C}$
Storage Temperature	T_{stg}		-55 to +150	$^\circ\text{C}$

Electrical Characteristics at $T_a=25^\circ\text{C}$

Parameter	Symbol	Conditions	Ratings			Unit
			min	typ	max	
Collector Cutoff Current	I_{CBO}	$V_{CB}=5\text{V}, I_E=0$			1.0	μA
Emitter Cutoff Current	I_{EBO}	$V_{EB}=1\text{V}, I_C=0$			1	μA
DC Current Gain	h_{FE}	$V_{CE}=3\text{V}, I_C=15\text{mA}$	80		160	
Gain-Bandwidth Product	f_{T1}	$V_{CE}=1\text{V}, I_C=5\text{mA}$		14		GHz
	f_{T2}	$V_{CE}=3\text{V}, I_C=15\text{mA}$	18	21		GHz
Output Capacitance	C_{ob}	$V_{CB}=1\text{V}, f=1\text{MHz}$		0.55	0.7	pF
Reverse Transfer Capacitance	C_{re}	$V_{CB}=1\text{V}, f=1\text{MHz}$		0.25		pF
Forward Transfer Gain	$ S_{21e} ^2_1$	$V_{CE}=1\text{V}, I_C=5\text{mA}, f=2\text{GHz}$	9	10.5		dB
	$ S_{21e} ^2_2$	$V_{CE}=3\text{V}, I_C=15\text{mA}, f=2\text{GHz}$		12.5		dB
Noise Figure	NF	$V_{CE}=1\text{V}, I_C=5\text{mA}, f=2\text{GHz}$		1.2		dB

■ Any and all SANYO products described or contained herein do not have specifications that can handle applications that require extremely high levels of reliability, such as life-support systems, aircraft's control systems, or other applications whose failure can be reasonably expected to result in serious physical and/or material damage. Consult with your SANYO representative nearest you before using any SANYO products described or contained herein in such applications.

■ SANYO assumes no responsibility for equipment failures that result from using products at values that exceed, even momentarily, rated values (such as maximum ratings, operating condition ranges, or other parameters) listed in products specifications of any and all SANYO products described or contained herein.

SANYO Electric Co., Ltd. Semiconductor Company

TOKYO OFFICE Tokyo Bldg., 1-10, 1 Chome, Ueno, Taito-ku, TOKYO, 110-8534 JAPAN

Package Dimensions

unit : mm
2106B

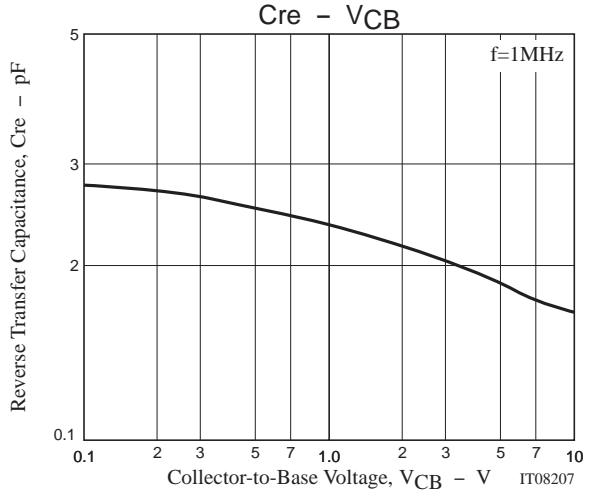
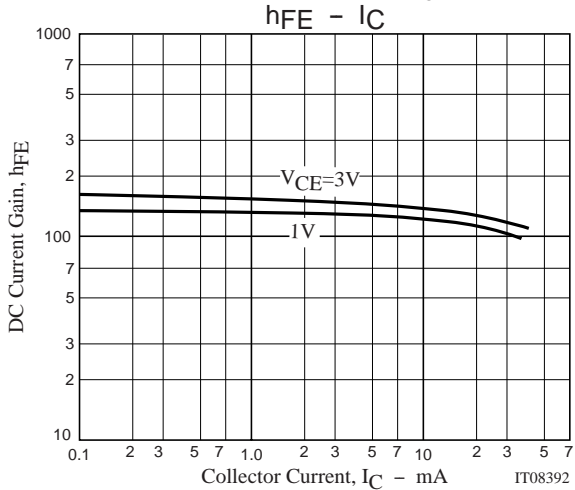
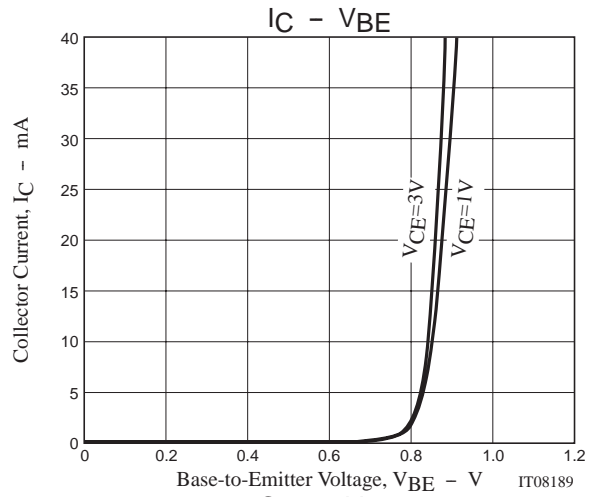
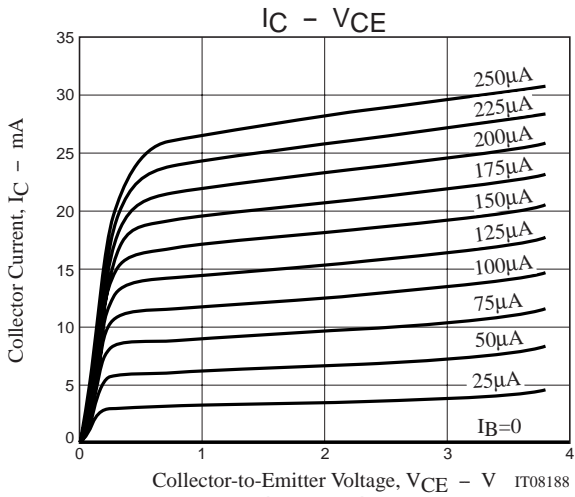
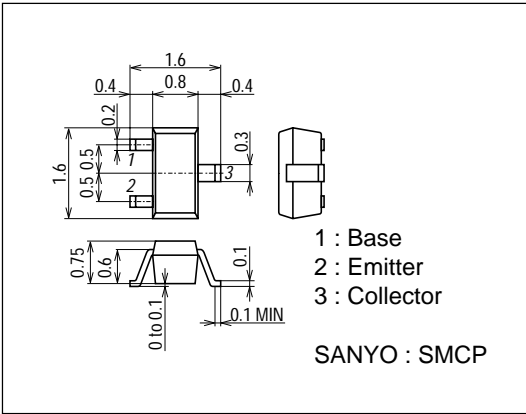

2SC6025

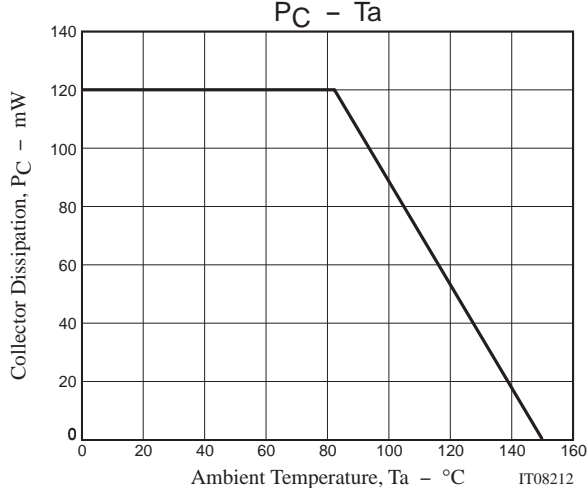
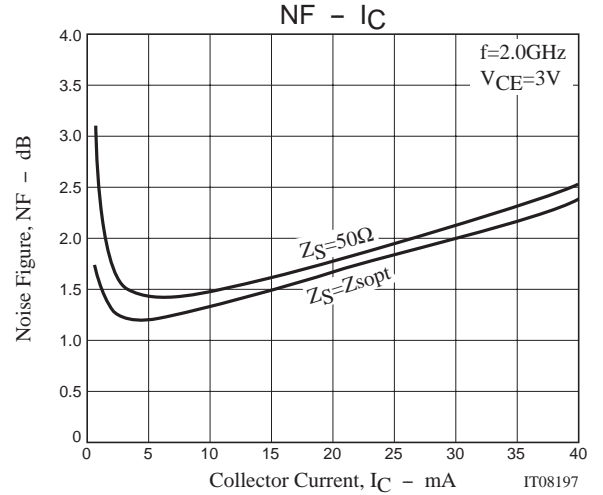
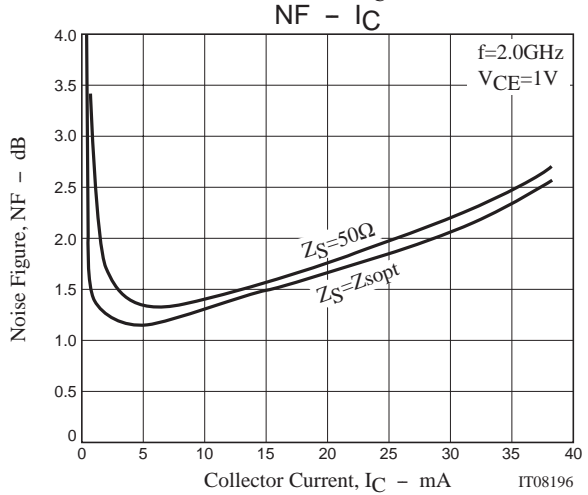
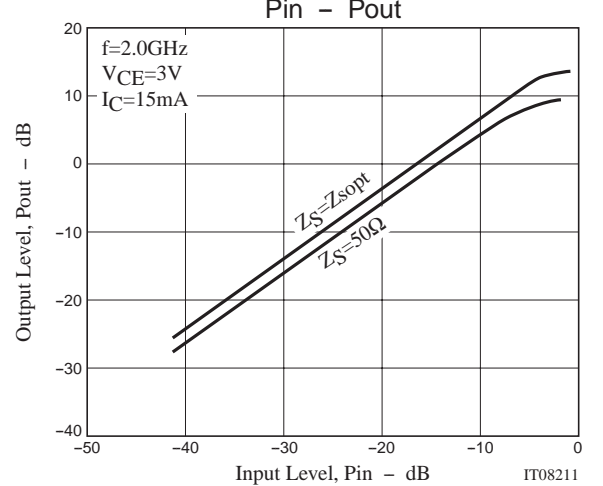
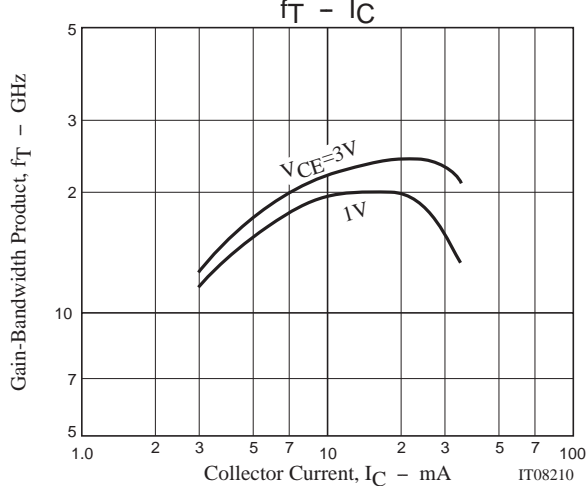
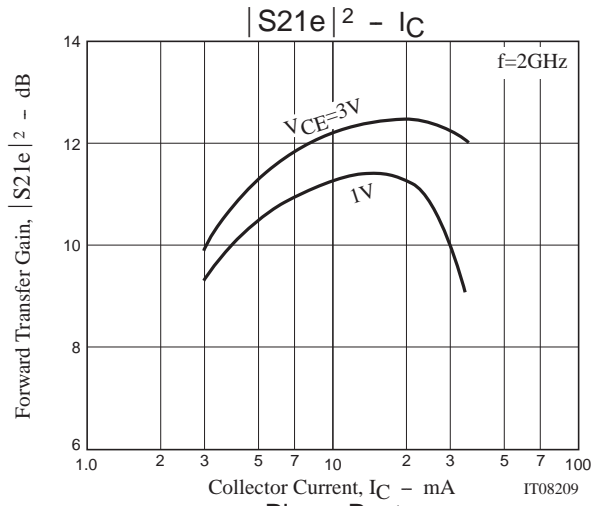
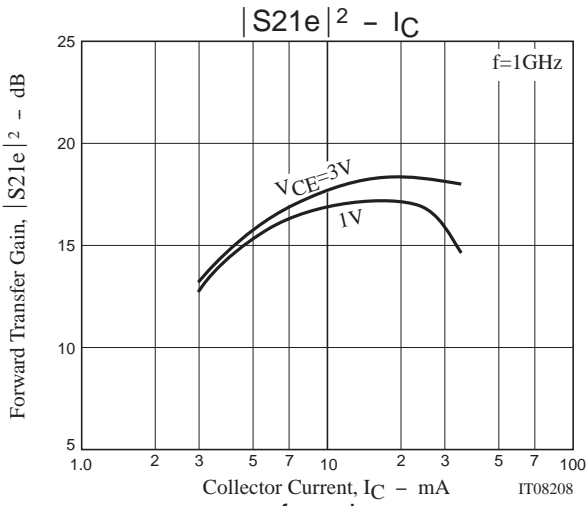

2SC6025

SPIICE PARAMETERS

model : Gummel-Poon

Parameter	Value	Unit	Parameter	Value	Unit
IS	124.2a	A	TF	4.500p	S
BF	168.7		XTF	10.00m	
NF	1.007		VTF	8	V
VAF	5.762	V	ITF	549.7m	A
IKF	141.1m	A	PTF	25	°C
ISE	181.0f	A	CJC	168.1f	F
NE	2.295		VJC	165.7m	V
BR	11.54		MJC	571.4m	
NR	1		XCJC	330.0m	
VAR	3.43	V	TR	10.00p	S
IKR	21.00m	A	FC	800.0m	
ISC	1.800f	A	CJS	0	F
NC	1.24		VJS	0	V
RB	2.86	Ω	MJS	0	
IRB	100.0μ	A	LE	998.0p	F
RBM	1.254	Ω	LB	988.0n	F
RE	1.297	Ω	LC	723.0p	F
RC	2.552	Ω	Cbc	30.00f	F
XTB	0		Cbe	386.0f	F
EG	1.11	eV	Cce	85.00f	F
XTI	3		CC	30.00f	H
CJE	98.40f	F	CCB	211.0f	H
VJE	10	V	CEC	235.3.f	H
MJE	100.0m				

SCHEMATIC

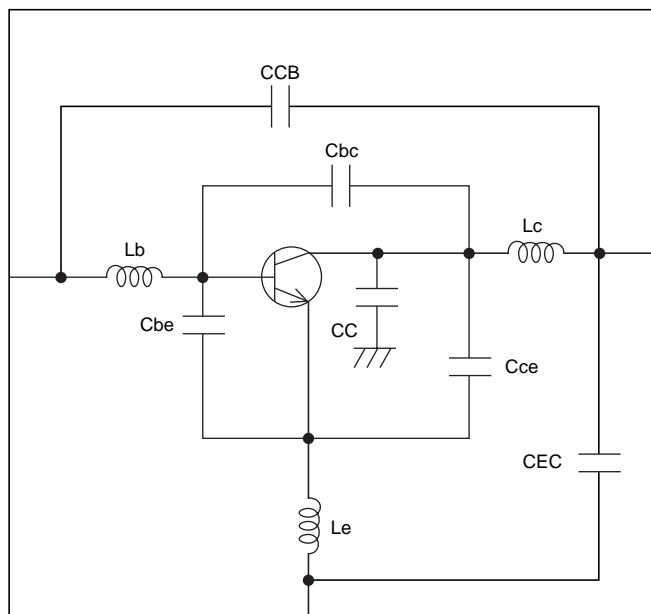

IT08213

*Information (including circuit diagrams and circuit parameters) herein is for example only ; it is not guaranteed for volume production.

2SC6025

S Parameters (Common emitter)

$V_{CE}=1V, I_C=5mA, Z_O=50\Omega$

Freq(MHz)	$ S_{11} $	$\angle S_{11}$	$ S_{21} $	$\angle S_{21}$	$ S_{12} $	$\angle S_{12}$	$ S_{22} $	$\angle S_{22}$
200	0.884	-18.0	8.097	156.1	0.029	80.9	0.928	-20.0
400	0.779	-38.0	8.134	137.1	0.054	74.3	0.808	-36.8
600	0.695	-53.9	6.928	124.9	0.074	68.2	0.681	-49.9
800	0.582	-69.9	6.257	112.6	0.090	65.0	0.582	-59.2
1000	0.469	-86.1	5.774	101.8	0.104	63.6	0.500	-66.0
1200	0.397	-98.4	5.105	93.9	0.117	62.9	0.441	-71.9
1400	0.354	-108.7	4.488	88.1	0.130	62.6	0.397	-76.6
1600	0.311	-118.3	4.055	82.4	0.143	62.3	0.361	-80.7
1800	0.285	-127.0	3.666	77.9	0.156	62.3	0.334	-84.9
2000	0.268	-135.6	3.350	73.6	0.170	61.9	0.312	-89.0
2200	0.254	-143.0	3.080	69.8	0.183	61.7	0.295	-92.6
2400	0.244	-151.0	2.869	66.0	0.197	61.4	0.280	-96.8
2600	0.238	-158.0	2.675	62.6	0.212	61.1	0.269	-100.6
2800	0.236	-164.9	2.513	59.3	0.226	60.5	0.260	-104.6
3000	0.235	-171.4	2.374	56.1	0.241	59.9	0.255	-108.7
3200	0.237	-177.3	2.252	53.1	0.257	59.2	0.250	-113.1
3400	0.240	176.9	2.147	50.1	0.272	58.5	0.248	-117.3
3600	0.245	171.8	2.055	47.2	0.289	57.6	0.246	-122.0
3800	0.252	167.0	1.971	44.4	0.305	56.6	0.247	-126.7
4000	0.259	162.3	1.895	41.6	0.322	55.4	0.248	-131.4
4200	0.267	157.8	1.826	38.9	0.338	54.2	0.250	-136.0
4400	0.276	153.8	1.765	36.2	0.354	52.9	0.253	-140.9
4600	0.286	149.8	1.705	33.6	0.371	51.6	0.257	-145.4
4800	0.296	146.1	1.654	31.0	0.388	50.2	0.262	-150.2
5000	0.306	142.5	1.604	28.5	0.404	48.8	0.268	-154.9
5200	0.315	139.1	1.557	26.1	0.421	47.2	0.274	-159.4
5400	0.328	135.8	1.515	23.7	0.437	45.7	0.281	-164.2
5600	0.339	132.4	1.473	21.4	0.453	44.0	0.289	-168.7
5800	0.350	129.4	1.434	19.1	0.470	42.4	0.297	-173.0
6000	0.361	126.7	1.399	16.8	0.485	40.7	0.305	-177.0

2SC6025

S Parameters (Common emitter)

$V_{CE}=1V$, $I_C=10mA$, $Z_O=50\Omega$

Freq(MHz)	$ S_{11} $	$\angle S_{11}$	$ S_{21} $	$\angle S_{21}$	$ S_{12} $	$\angle S_{12}$	$ S_{22} $	$\angle S_{22}$
200	0.761	-28.4	13.148	148.0	0.026	79.5	0.851	-27.2
400	0.606	-55.3	12.589	125.9	0.047	73.4	0.673	-45.4
600	0.471	-77.1	10.264	110.2	0.063	71.3	0.536	-57.4
800	0.375	-93.5	8.283	99.6	0.080	70.7	0.443	-65.2
1000	0.310	-107.0	6.873	92.1	0.095	70.6	0.377	-70.9
1200	0.271	-118.0	5.836	86.3	0.111	70.1	0.331	-75.8
1400	0.247	-128.8	5.047	81.7	0.126	69.6	0.297	-79.9
1600	0.229	-138.3	4.461	77.5	0.142	69.1	0.272	-83.7
1800	0.218	-146.7	4.003	73.8	0.158	68.3	0.252	-87.7
2000	0.214	-155.0	3.632	70.2	0.175	67.4	0.236	-91.9
2200	0.209	-162.1	3.328	67.0	0.191	66.5	0.225	-95.5
2400	0.208	-169.2	3.081	63.7	0.207	65.4	0.215	-99.9
2600	0.209	-175.5	2.868	60.7	0.223	64.5	0.208	-104.0
2800	0.212	178.4	2.687	57.8	0.239	63.4	0.202	-108.3
3000	0.215	173.0	2.533	54.9	0.256	62.3	0.199	-112.7
3200	0.221	168.2	2.399	52.2	0.272	61.0	0.197	-117.6
3400	0.227	163.4	2.282	49.5	0.289	59.7	0.197	-121.9
3600	0.235	159.2	2.181	46.9	0.306	58.4	0.197	-126.9
3800	0.243	155.3	2.090	44.3	0.322	57.0	0.199	-131.9
4000	0.251	151.4	2.007	41.7	0.339	55.5	0.202	-136.7
4200	0.259	147.8	1.933	39.2	0.355	54.1	0.205	-141.6
4400	0.270	144.5	1.865	36.6	0.371	52.4	0.210	-146.7
4600	0.279	141.1	1.802	34.2	0.388	50.9	0.215	-151.3
4800	0.289	138.3	1.747	31.8	0.404	49.3	0.220	-156.1
5000	0.300	135.2	1.693	29.4	0.419	47.6	0.227	-160.7
5200	0.309	132.4	1.644	27.1	0.435	45.9	0.233	-165.2
5400	0.321	129.6	1.599	24.8	0.450	44.3	0.241	-169.9
5600	0.332	126.7	1.555	22.6	0.465	42.6	0.250	-174.2
5800	0.342	124.1	1.515	20.4	0.480	40.9	0.257	-178.2
6000	0.353	121.7	1.478	18.2	0.494	39.2	0.266	177.9

2SC6025

S Parameters (Common emitter)

$V_{CE}=1V, I_C=15mA, Z_O=50\Omega$

Freq(MHz)	$ S_{11} $	$\angle S_{11}$	$ S_{21} $	$\angle S_{21}$	$ S_{12} $	$\angle S_{12}$	$ S_{22} $	$\angle S_{22}$
200	0.631	-43.0	15.419	141.1	0.025	76.7	0.789	-31.4
400	0.473	-71.4	14.382	117.8	0.043	74.1	0.591	-49.3
600	0.361	-91.2	11.142	103.4	0.060	74.2	0.464	-60.2
800	0.297	-107.0	8.699	94.6	0.077	74.0	0.381	-67.3
1000	0.255	-119.7	7.085	88.4	0.094	73.9	0.324	-72.4
1200	0.232	-131.4	5.969	83.4	0.110	73.2	0.286	-77.1
1400	0.218	-141.2	5.147	79.3	0.127	72.4	0.257	-81.2
1600	0.209	-150.5	4.536	75.5	0.144	71.5	0.236	-84.8
1800	0.205	-158.4	4.057	72.1	0.161	70.4	0.220	-89.2
2000	0.205	-165.9	3.679	68.7	0.178	69.2	0.207	-93.5
2200	0.204	-172.5	3.367	65.6	0.194	68.2	0.198	-97.2
2400	0.207	-178.7	3.115	62.6	0.211	66.8	0.190	-101.9
2600	0.210	175.6	2.898	59.7	0.228	65.6	0.185	-106.2
2800	0.215	170.2	2.714	56.9	0.245	64.3	0.180	-110.8
3000	0.221	165.5	2.556	54.2	0.261	62.9	0.179	-115.4
3200	0.226	161.2	2.421	51.5	0.279	61.5	0.178	-120.3
3400	0.234	157.1	2.302	48.9	0.296	60.1	0.179	-125.0
3600	0.242	153.4	2.199	46.4	0.312	58.6	0.180	-130.3
3800	0.250	150.0	2.107	43.8	0.329	57.1	0.183	-135.4
4000	0.259	146.5	2.022	41.3	0.346	55.5	0.187	-140.3
4200	0.268	143.2	1.948	38.8	0.362	53.9	0.191	-145.3
4400	0.278	140.3	1.878	36.4	0.378	52.2	0.196	-150.3
4600	0.288	137.2	1.815	34.0	0.395	50.5	0.202	-155.0
4800	0.297	134.6	1.759	31.6	0.410	48.9	0.207	-159.8
5000	0.308	131.7	1.705	29.3	0.426	47.2	0.215	-164.4
5200	0.317	129.1	1.655	27.0	0.441	45.4	0.222	-168.7
5400	0.329	126.6	1.609	24.8	0.456	43.7	0.231	-173.4
5600	0.339	123.9	1.566	22.6	0.470	42.0	0.239	-177.6
5800	0.349	121.5	1.525	20.5	0.485	40.2	0.247	178.5
6000	0.360	119.2	1.488	18.3	0.499	38.5	0.256	174.7

2SC6025

S Parameters (Common emitter)

$V_{CE}=1V$, $I_C=20mA$, $Z_0=50\Omega$

Freq(MHz)	$ S_{11} $	$\angle S_{11}$	$ S_{21} $	$\angle S_{21}$	$ S_{12} $	$\angle S_{12}$	$ S_{22} $	$\angle S_{22}$
200	0.522	-61.0	16.301	135.2	0.024	77.2	0.735	-34.3
400	0.384	-89.3	14.295	112.3	0.041	75.8	0.534	-51.5
600	0.307	-104.6	11.085	99.7	0.058	76.1	0.416	-61.7
800	0.264	-119.5	8.621	91.9	0.076	76.1	0.342	-68.3
1000	0.236	-131.5	7.018	86.4	0.093	75.8	0.292	-73.3
1200	0.222	-142.4	5.908	81.7	0.110	74.7	0.258	-78.0
1400	0.216	-151.9	5.087	77.8	0.128	73.8	0.234	-82.0
1600	0.211	-160.2	4.482	74.2	0.145	72.7	0.216	-85.9
1800	0.210	-167.2	4.011	70.9	0.162	71.5	0.202	-90.4
2000	0.214	-174.1	3.634	67.6	0.180	70.1	0.191	-94.9
2200	0.214	179.9	3.326	64.7	0.197	68.9	0.183	-98.9
2400	0.218	174.6	3.078	61.6	0.214	67.5	0.176	-103.9
2600	0.223	169.4	2.863	58.8	0.231	66.2	0.173	-108.2
2800	0.229	164.7	2.680	56.1	0.249	64.7	0.170	-113.0
3000	0.235	160.4	2.525	53.4	0.266	63.3	0.169	-117.9
3200	0.241	156.6	2.391	50.7	0.283	61.8	0.169	-122.8
3400	0.249	152.9	2.274	48.2	0.300	60.3	0.170	-127.7
3600	0.257	149.4	2.172	45.6	0.317	58.7	0.173	-133.0
3800	0.266	146.3	2.080	43.1	0.334	57.0	0.177	-138.3
4000	0.275	143.0	1.996	40.6	0.351	55.5	0.182	-143.2
4200	0.284	140.0	1.923	38.2	0.367	53.8	0.186	-148.1
4400	0.293	137.3	1.854	35.7	0.383	52.0	0.192	-153.1
4600	0.304	134.4	1.792	33.4	0.400	50.4	0.198	-157.9
4800	0.313	131.9	1.735	31.0	0.416	48.7	0.205	-162.5
5000	0.323	129.2	1.682	28.7	0.431	46.9	0.213	-167.0
5200	0.332	126.8	1.633	26.5	0.446	45.1	0.221	-171.3
5400	0.344	124.3	1.588	24.2	0.461	43.4	0.229	-175.9
5600	0.354	121.7	1.546	22.1	0.475	41.6	0.239	-180.0
5800	0.364	119.4	1.505	20.0	0.489	39.8	0.247	176.2
6000	0.374	117.2	1.469	17.8	0.503	38.0	0.256	172.5

2SC6025

S Parameters (Common emitter)

$V_{CE}=1V, I_C=25mA, Z_O=50\Omega$

Freq(MHz)	$ S_{11} $	$\angle S_{11}$	$ S_{21} $	$\angle S_{21}$	$ S_{12} $	$\angle S_{12}$	$ S_{22} $	$\angle S_{22}$
200	0.458	-78.5	16.372	130.6	0.023	77.5	0.692	-36.3
400	0.350	-106.3	13.415	108.9	0.040	75.9	0.490	-52.9
600	0.290	-118.9	10.522	97.5	0.058	76.5	0.381	-62.7
800	0.260	-132.5	8.230	90.2	0.075	77.3	0.315	-69.2
1000	0.239	-142.9	6.748	84.9	0.093	76.5	0.270	-74.2
1200	0.230	-152.4	5.702	80.5	0.111	75.4	0.240	-79.0
1400	0.228	-160.8	4.912	76.6	0.128	74.5	0.218	-83.1
1600	0.226	-168.4	4.332	73.1	0.146	73.3	0.202	-87.1
1800	0.227	-174.6	3.881	69.8	0.164	72.0	0.190	-91.9
2000	0.232	179.4	3.516	66.5	0.181	70.6	0.181	-96.7
2200	0.235	174.1	3.219	63.6	0.199	69.3	0.174	-100.7
2400	0.239	169.4	2.984	60.6	0.216	67.8	0.169	-106.0
2600	0.244	164.8	2.778	57.8	0.234	66.3	0.166	-110.5
2800	0.250	160.4	2.601	55.0	0.251	64.9	0.164	-115.5
3000	0.256	156.5	2.450	52.4	0.268	63.4	0.165	-120.5
3200	0.263	153.0	2.321	49.7	0.286	61.8	0.166	-125.5
3400	0.271	149.5	2.206	47.1	0.303	60.3	0.168	-130.4
3600	0.280	146.3	2.109	44.6	0.320	58.7	0.171	-135.8
3800	0.288	143.3	2.020	42.1	0.337	57.1	0.176	-141.0
4000	0.298	140.3	1.939	39.6	0.355	55.4	0.181	-146.0
4200	0.306	137.4	1.867	37.1	0.371	53.6	0.187	-150.8
4400	0.316	134.8	1.800	34.6	0.388	51.9	0.194	-155.8
4600	0.325	132.1	1.740	32.3	0.404	50.2	0.200	-160.4
4800	0.335	129.6	1.686	30.0	0.420	48.4	0.207	-165.0
5000	0.345	127.0	1.634	27.7	0.435	46.6	0.216	-169.4
5200	0.354	124.5	1.586	25.4	0.451	44.8	0.224	-173.8
5400	0.365	122.1	1.543	23.2	0.465	43.1	0.233	-178.1
5600	0.375	119.6	1.501	21.1	0.480	41.3	0.243	177.8
5800	0.385	117.4	1.462	19.0	0.494	39.4	0.252	174.0
6000	0.395	115.2	1.426	16.8	0.508	37.6	0.261	170.4

2SC6025

S Parameters (Common emitter)

$V_{CE}=3V$, $I_C=5mA$, $Z_O=50\Omega$

Freq(MHz)	$ S_{11} $	$\angle S_{11}$	$ S_{21} $	$\angle S_{21}$	$ S_{12} $	$\angle S_{12}$	$ S_{22} $	$\angle S_{22}$
200	0.903	-15.3	8.152	157.3	0.023	85.3	0.941	-16.6
400	0.820	-32.6	8.273	140.0	0.045	79.3	0.850	-31.6
600	0.732	-47.2	7.296	127.6	0.065	73.5	0.736	-43.5
800	0.635	-59.8	6.411	116.1	0.080	70.1	0.636	-51.9
1000	0.520	-75.1	6.117	105.6	0.093	68.0	0.554	-58.2
1200	0.428	-86.3	5.532	96.9	0.106	67.3	0.492	-62.9
1400	0.374	-95.0	4.901	90.9	0.119	66.7	0.445	-66.8
1600	0.329	-103.3	4.415	85.5	0.131	66.3	0.408	-70.4
1800	0.297	-110.6	3.996	80.8	0.144	66.2	0.379	-73.7
2000	0.269	-118.0	3.666	76.4	0.157	66.1	0.355	-76.9
2200	0.250	-125.1	3.376	72.5	0.170	65.7	0.336	-80.0
2400	0.235	-132.5	3.141	68.8	0.184	65.5	0.320	-83.2
2600	0.224	-139.3	2.935	65.4	0.198	65.0	0.309	-86.5
2800	0.216	-146.0	2.758	62.0	0.212	64.7	0.298	-89.9
3000	0.209	-152.8	2.603	58.9	0.226	64.2	0.289	-93.3
3200	0.207	-159.1	2.471	55.9	0.242	63.5	0.284	-97.0
3400	0.208	-165.2	2.357	53.0	0.257	62.8	0.279	-100.8
3600	0.210	-171.1	2.255	50.1	0.273	62.0	0.276	-105.0
3800	0.214	-176.8	2.164	47.2	0.290	61.1	0.274	-109.4
4000	0.219	177.7	2.081	44.4	0.306	60.0	0.273	-113.8
4200	0.226	172.8	2.006	41.7	0.323	58.9	0.273	-118.3
4400	0.233	168.0	1.937	39.0	0.340	57.6	0.273	-123.0
4600	0.240	163.2	1.874	36.3	0.357	56.3	0.276	-127.9
4800	0.251	158.9	1.815	33.7	0.375	54.9	0.278	-132.7
5000	0.261	154.8	1.761	31.2	0.391	53.6	0.281	-137.5
5200	0.272	150.9	1.708	28.7	0.409	52.1	0.285	-142.4
5400	0.282	147.2	1.662	26.3	0.426	50.5	0.291	-147.3
5600	0.293	143.5	1.617	23.9	0.443	49.0	0.296	-151.9
5800	0.305	140.1	1.576	21.5	0.460	47.3	0.302	-156.7
6000	0.317	136.9	1.535	19.2	0.478	45.6	0.309	-161.3

2SC6025

S Parameters (Common emitter)

$V_{CE}=3V$, $I_C=10mA$, $Z_O=50\Omega$

Freq(MHz)	$ S_{11} $	$\angle S_{11}$	$ S_{21} $	$\angle S_{21}$	$ S_{12} $	$\angle S_{12}$	$ S_{22} $	$\angle S_{22}$
200	0.806	-21.8	14.515	150.7	0.021	81.2	0.884	-21.8
400	0.672	-45.0	13.289	129.8	0.040	79.0	0.740	-38.1
600	0.535	-63.4	10.969	114.3	0.056	76.3	0.606	-48.7
800	0.419	-78.1	9.068	102.9	0.071	75.1	0.510	-55.4
1000	0.337	-89.8	7.593	94.8	0.087	74.2	0.440	-60.1
1200	0.284	-99.1	6.461	88.9	0.102	73.7	0.390	-63.7
1400	0.248	-107.8	5.600	84.1	0.116	73.2	0.353	-66.7
1600	0.223	-116.0	4.948	80.0	0.131	72.5	0.325	-69.5
1800	0.205	-123.6	4.438	76.2	0.146	71.7	0.303	-72.3
2000	0.190	-131.4	4.031	72.8	0.161	70.9	0.286	-75.1
2200	0.181	-138.9	3.695	69.5	0.176	70.1	0.271	-78.1
2400	0.174	-146.7	3.419	66.3	0.192	69.1	0.260	-81.2
2600	0.171	-153.4	3.184	63.4	0.208	68.2	0.252	-84.5
2800	0.169	-160.2	2.984	60.5	0.223	67.3	0.243	-87.9
3000	0.168	-167.0	2.809	57.7	0.239	66.2	0.237	-91.4
3200	0.171	-172.8	2.662	55.0	0.255	65.1	0.233	-95.3
3400	0.175	-178.4	2.553	52.4	0.272	63.9	0.230	-99.3
3600	0.181	176.4	2.419	49.8	0.287	62.7	0.227	-103.7
3800	0.187	171.5	2.319	47.2	0.304	61.3	0.226	-108.2
4000	0.195	166.9	2.227	44.6	0.321	60.0	0.225	-112.9
4200	0.203	162.5	2.145	42.1	0.338	58.5	0.226	-117.7
4400	0.211	158.5	2.070	39.5	0.354	57.0	0.227	-122.7
4600	0.220	154.4	2.001	37.1	0.370	55.5	0.229	-127.7
4800	0.231	150.8	1.936	34.7	0.387	54.0	0.231	-132.8
5000	0.242	147.4	1.878	32.3	0.403	52.5	0.235	-137.8
5200	0.253	144.0	1.822	29.9	0.419	50.8	0.239	-142.7
5400	0.264	141.0	1.772	27.6	0.436	49.2	0.244	-147.7
5600	0.275	137.9	1.726	25.4	0.452	47.6	0.250	-152.5
5800	0.286	134.9	1.682	23.1	0.467	45.9	0.256	-157.4
6000	0.299	132.2	1.638	20.9	0.483	44.2	0.262	-162.1

2SC6025

S Parameters (Common emitter)

$V_{CE}=3V, I_C=15mA, Z_0=50\Omega$

Freq(MHz)	$ S_{11} $	$\angle S_{11}$	$ S_{21} $	$\angle S_{21}$	$ S_{12} $	$\angle S_{12}$	$ S_{22} $	$\angle S_{22}$
200	0.714	-27.6	19.486	145.9	0.020	81.3	0.841	-24.7
400	0.549	-53.7	16.232	122.3	0.037	80.2	0.675	-40.5
600	0.412	-72.2	12.452	107.1	0.053	78.5	0.544	-50.0
800	0.323	-85.9	9.778	97.4	0.069	78.3	0.456	-55.6
1000	0.266	-96.7	7.959	90.9	0.084	77.7	0.395	-59.6
1200	0.228	-106.2	6.702	85.8	0.100	76.9	0.352	-62.5
1400	0.202	-115.3	5.777	81.6	0.116	76.0	0.321	-65.3
1600	0.184	-124.1	5.092	77.9	0.132	75.0	0.297	-67.9
1800	0.172	-132.2	4.556	74.5	0.147	74.0	0.279	-70.5
2000	0.163	-140.0	4.125	71.2	0.163	72.8	0.264	-73.4
2200	0.158	-148.2	3.780	68.2	0.179	71.7	0.252	-76.2
2400	0.156	-155.9	3.491	65.2	0.195	70.6	0.242	-79.3
2600	0.155	-162.5	3.247	62.5	0.211	69.4	0.235	-82.7
2800	0.157	-169.5	3.042	59.7	0.227	68.1	0.228	-86.0
3000	0.158	-175.8	2.861	57.1	0.243	67.0	0.222	-89.5
3200	0.162	178.7	2.709	54.5	0.260	65.8	0.219	-93.5
3400	0.169	173.9	2.576	51.9	0.276	64.4	0.216	-97.7
3600	0.175	169.3	2.460	49.4	0.293	63.0	0.214	-102.1
3800	0.183	164.7	2.356	46.9	0.310	61.6	0.213	-106.8
4000	0.192	160.7	2.263	44.4	0.326	60.2	0.212	-111.4
4200	0.200	156.8	2.179	42.0	0.343	58.7	0.212	-116.3
4400	0.210	153.1	2.102	39.6	0.359	57.0	0.213	-121.5
4600	0.219	149.6	2.030	37.1	0.375	55.5	0.215	-126.6
4800	0.230	146.5	1.965	34.8	0.391	53.9	0.218	-131.7
5000	0.241	143.4	1.906	32.5	0.408	52.3	0.220	-136.7
5200	0.252	140.3	1.849	30.2	0.424	50.6	0.224	-141.8
5400	0.263	137.7	1.799	27.9	0.440	49.0	0.229	-146.8
5600	0.274	134.9	1.751	25.7	0.455	47.3	0.234	-151.8
5800	0.286	132.2	1.706	23.5	0.470	45.6	0.239	-156.7
6000	0.297	129.6	1.663	21.3	0.485	43.9	0.246	-161.5

2SC6025

S Parameters (Common emitter)

$V_{CE}=3V, I_C=20mA, Z_0=50\Omega$

Freq(MHz)	$ S_{11} $	$\angle S_{11}$	$ S_{21} $	$\angle S_{21}$	$ S_{12} $	$\angle S_{12}$	$ S_{22} $	$\angle S_{22}$
200	0.638	-32.3	22.950	142.4	0.019	80.4	0.813	-26.1
400	0.465	-59.0	17.658	117.7	0.036	80.4	0.637	-41.5
600	0.349	-77.2	12.983	103.5	0.051	80.9	0.512	-49.9
800	0.278	-90.7	10.012	94.9	0.067	80.4	0.429	-55.0
1000	0.234	-102.0	8.091	89.0	0.083	79.4	0.374	-58.5
1200	0.204	-111.9	6.783	84.3	0.099	78.4	0.334	-61.3
1400	0.183	-121.5	5.841	80.3	0.116	77.4	0.305	-63.8
1600	0.171	-130.5	5.137	76.8	0.132	76.3	0.284	-66.2
1800	0.163	-138.4	4.594	73.5	0.148	75.2	0.268	-68.9
2000	0.157	-146.5	4.158	70.4	0.164	74.0	0.254	-71.7
2200	0.154	-154.2	3.807	67.4	0.180	72.7	0.243	-74.7
2400	0.154	-161.6	3.517	64.6	0.196	71.5	0.233	-77.8
2600	0.156	-167.9	3.270	61.8	0.213	70.3	0.227	-81.2
2800	0.158	-174.1	3.062	59.1	0.229	68.9	0.220	-84.7
3000	0.161	179.8	2.881	56.5	0.245	67.6	0.215	-88.3
3200	0.166	174.9	2.727	54.0	0.262	66.3	0.213	-92.3
3400	0.173	170.4	2.593	51.5	0.279	64.9	0.210	-96.8
3600	0.181	166.1	2.475	49.0	0.296	63.5	0.208	-101.3
3800	0.188	162.0	2.371	46.5	0.312	62.0	0.207	-106.1
4000	0.198	158.2	2.277	44.1	0.329	60.5	0.207	-111.0
4200	0.207	154.9	2.192	41.7	0.347	58.9	0.208	-116.0
4400	0.215	151.3	2.114	39.2	0.363	57.3	0.209	-121.2
4600	0.226	147.8	2.042	36.8	0.379	55.7	0.211	-126.5
4800	0.237	144.8	1.978	34.5	0.395	54.0	0.214	-131.9
5000	0.248	141.8	1.917	32.2	0.411	52.4	0.218	-136.9
5200	0.258	139.0	1.860	29.9	0.427	50.7	0.222	-142.1
5400	0.270	136.3	1.809	27.6	0.444	49.0	0.227	-147.2
5600	0.281	133.6	1.760	25.5	0.459	47.3	0.233	-152.2
5800	0.292	131.0	1.715	23.2	0.474	45.6	0.239	-157.1
6000	0.304	128.5	1.672	21.2	0.489	43.8	0.246	-161.9

2SC6025

S Parameters (Common emitter)

$V_{CE}=3V$, $I_C=25mA$, $Z_O=50\Omega$

Freq(MHz)	$ S_{11} $	$\angle S_{11}$	$ S_{21} $	$\angle S_{21}$	$ S_{12} $	$\angle S_{12}$	$ S_{22} $	$\angle S_{22}$
200	0.567	-36.8	25.354	139.3	0.018	81.7	0.790	-27.0
400	0.403	-63.6	18.284	114.6	0.034	81.9	0.612	-41.5
600	0.306	-81.7	13.142	101.3	0.050	82.2	0.492	-49.2
800	0.249	-95.9	10.045	93.3	0.066	81.4	0.415	-53.8
1000	0.213	-107.6	8.091	87.6	0.083	80.3	0.363	-57.0
1200	0.189	-117.8	6.768	83.2	0.099	79.6	0.326	-59.6
1400	0.173	-127.9	5.821	79.3	0.115	78.5	0.300	-62.1
1600	0.165	-137.0	5.119	75.9	0.131	77.4	0.280	-64.5
1800	0.159	-145.0	4.572	72.6	0.148	76.1	0.265	-67.1
2000	0.155	-152.9	4.140	69.6	0.164	74.9	0.253	-69.9
2200	0.155	-160.4	3.791	66.7	0.180	73.6	0.242	-72.9
2400	0.158	-167.2	3.501	63.8	0.197	72.2	0.233	-76.1
2600	0.160	-173.2	3.255	61.2	0.214	70.9	0.228	-79.6
2800	0.164	-179.0	3.048	58.4	0.230	69.6	0.221	-83.1
3000	0.168	175.7	2.866	55.9	0.246	68.2	0.217	-86.8
3200	0.174	171.0	2.715	53.4	0.263	66.9	0.214	-90.8
3400	0.181	167.0	2.579	50.8	0.280	65.4	0.212	-95.2
3600	0.189	163.0	2.463	48.4	0.297	63.9	0.210	-99.8
3800	0.197	159.1	2.360	45.9	0.314	62.4	0.210	-104.6
4000	0.207	155.6	2.266	43.4	0.331	60.9	0.210	-109.7
4200	0.216	152.3	2.181	41.0	0.348	59.3	0.211	-114.8
4400	0.225	149.1	2.103	38.6	0.364	57.7	0.212	-120.0
4600	0.236	145.8	2.032	36.2	0.382	56.0	0.214	-125.3
4800	0.247	142.9	1.967	33.9	0.398	54.3	0.217	-130.6
5000	0.258	140.2	1.906	31.6	0.415	52.7	0.221	-135.7
5200	0.269	137.4	1.850	29.2	0.431	51.0	0.225	-141.1
5400	0.280	134.8	1.798	27.0	0.447	49.2	0.230	-146.3
5600	0.292	132.1	1.750	24.8	0.462	47.5	0.236	-151.3
5800	0.303	129.6	1.705	22.6	0.478	45.7	0.242	-156.3
6000	0.315	127.1	1.662	20.4	0.493	43.9	0.249	-161.1

- Specifications of any and all SANYO products described or contained herein stipulate the performance, characteristics, and functions of the described products in the independent state, and are not guarantees of the performance, characteristics, and functions of the described products as mounted in the customer's products or equipment. To verify symptoms and states that cannot be evaluated in an independent device, the customer should always evaluate and test devices mounted in the customer's products or equipment.
- SANYO Electric Co., Ltd. strives to supply high-quality high-reliability products. However, any and all semiconductor products fail with some probability. It is possible that these probabilistic failures could give rise to accidents or events that could endanger human lives, that could give rise to smoke or fire, or that could cause damage to other property. When designing equipment, adopt safety measures so that these kinds of accidents or events cannot occur. Such measures include but are not limited to protective circuits and error prevention circuits for safe design, redundant design, and structural design.
- In the event that any or all SANYO products(including technical data, services) described or contained herein are controlled under any of applicable local export control laws and regulations, such products must not be exported without obtaining the export license from the authorities concerned in accordance with the above law.
- No part of this publication may be reproduced or transmitted in any form or by any means, electronic or mechanical, including photocopying and recording, or any information storage or retrieval system, or otherwise, without the prior written permission of SANYO Electric Co., Ltd.
- Any and all information described or contained herein are subject to change without notice due to product/technology improvement, etc. When designing equipment, refer to the "Delivery Specification" for the SANYO product that you intend to use.
- Information (including circuit diagrams and circuit parameters) herein is for example only ; it is not guaranteed for volume production. SANYO believes information herein is accurate and reliable, but no guarantees are made or implied regarding its use or any infringements of intellectual property rights or other rights of third parties.

This catalog provides information as of March, 2005. Specifications and information herein are subject to change without notice.