

DATA SHEET

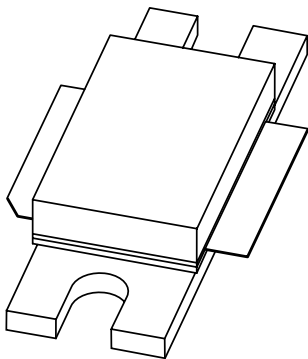

BLV2047 UHF power transistor

Product specification
Supersedes data of 1999 Jan 28

1999 Jun 09

UHF power transistor

BLV2047

FEATURES

- Emitter ballasting resistors for optimum temperature profile
- Gold metallization ensures excellent reliability
- Internal input and output matching for easy design of wideband circuits
- AlN substrate package for environmental safety.

APPLICATIONS

- Common emitter class-AB operation for PCN (Personal Communication Networks) and PCS (Personal Communication Services) base station applications in the 1800 to 2000 MHz frequency range.

DESCRIPTION

NPN silicon planar power transistor in a 2-lead SOT468A flange package with ceramic cap. The emitter is connected to the flange.

PINNING - SOT468A

PIN	DESCRIPTION
1	collector
2	base
3	emitter; connected to flange

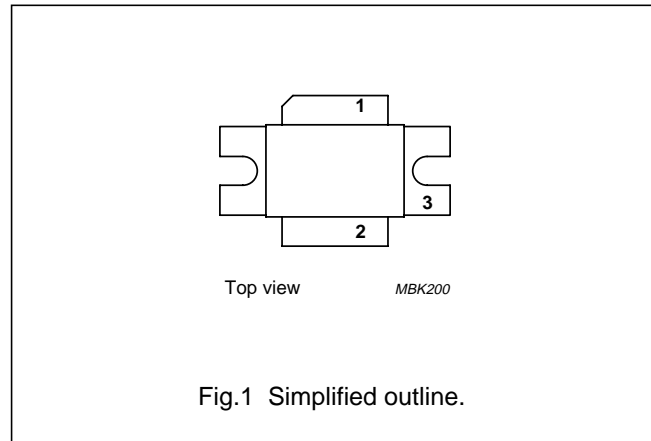

QUICK REFERENCE DATA

RF performance at $T_h = 25\text{ °C}$ in a common emitter test circuit.

MODE OF OPERATION	f (MHz)	V_{CE} (V)	P_L (W)	G_p (dB)	η_c (%)	d_{im} (dBc)
CW, class-AB	2000	26	60	≥ 8.5	≥ 40	–
2-tone, class-AB	$f_1 = 2000.0; f_2 = 2000.1$	26	60 (PEP)	≥ 9	≥ 33	≤ -30

LIMITING VALUES

In accordance with the Absolute Maximum Rating System (IEC 134).

SYMBOL	PARAMETER	CONDITIONS	MIN.	MAX.	UNIT
V_{CBO}	collector-base voltage	open emitter	–	65	V
V_{CEO}	collector-emitter voltage	open base	–	27	V
V_{EBO}	emitter-base voltage	open collector	–	3	V
I_C	collector current (DC)		–	10	A
P_{tot}	total power dissipation	$T_{mb} = 25\text{ °C}$	–	270	W
T_{stg}	storage temperature		–65	+150	°C
T_j	operating junction temperature		–	200	°C

UHF power transistor

BLV2047

THERMAL CHARACTERISTICS

SYMBOL	PARAMETER	CONDITIONS	VALUE	UNIT
$R_{th\ j-mb}$	thermal resistance from junction to mounting base	$P_{tot} = 270\ W; T_{mb} = 25\ ^\circ C; \text{note } 1$	0.65	K/W
$R_{th\ mb-h}$	thermal resistance from mounting base to heatsink		0.25	K/W

Note

1. Thermal resistance is determined under specified RF operating conditions.

CHARACTERISTICS

$T_j = 25\ ^\circ C$ unless otherwise specified.

SYMBOL	PARAMETER	CONDITIONS	MIN.	TYP.	MAX.	UNIT
$V_{(BR)CBO}$	collector-base breakdown voltage	open emitter; $I_C = 40\ mA$	65	–	–	V
$V_{(BR)CEO}$	collector-emitter breakdown voltage	open base; $I_C = 120\ mA$	27	–	–	V
$V_{(BR)EBO}$	emitter-base breakdown voltage	open collector; $I_E = 40\ mA$	3	–	–	V
I_{CES}	collector leakage current	$V_{CE} = 26\ V; V_{BE} = 0$	–	–	8	mA
h_{FE}	DC current gain	$V_{CE} = 10\ V; I_C = 4\ A$	45	–	100	
C_c	collector capacitance	$V_{CB} = 26\ V; I_E = i_e = 0; f = 1\ MHz; \text{note } 1$	–	72	–	pF
C_{re}	feedback capacitance	$V_{CE} = 26\ V; I_C = 0; f = 1\ MHz$	–	41	–	pF

Note

1. Capacitance of die only.

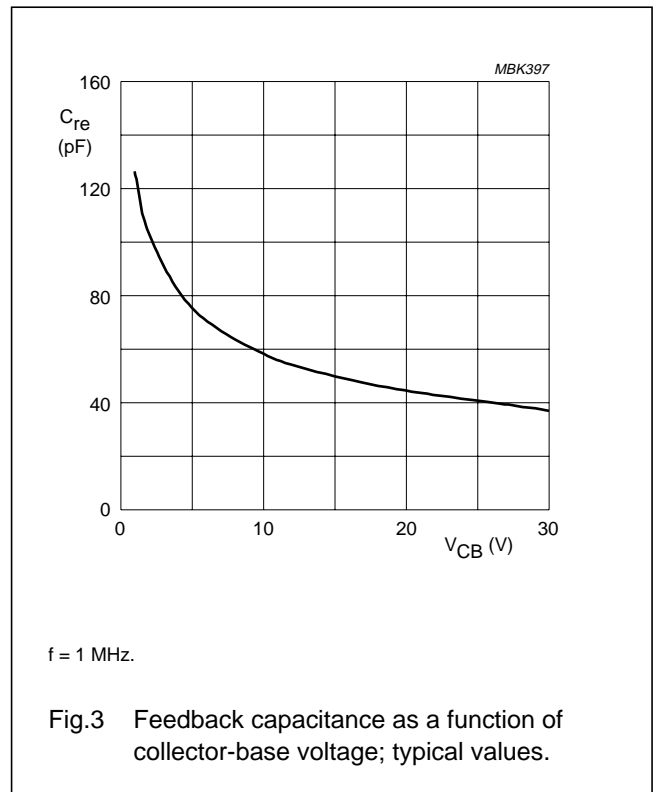
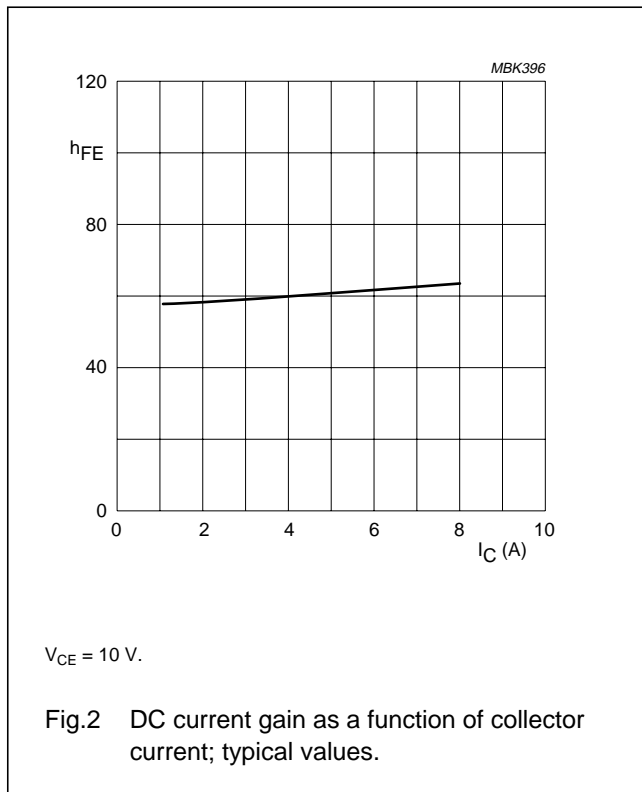

UHF power transistor

BLV2047

APPLICATION INFORMATION

RF performance at $T_h = 25\text{ }^\circ\text{C}$ in a common emitter test circuit.

MODE OF OPERATION	f (MHz)	V _{CE} (V)	I _{CQ} (mA)	P _L (W)	G _p (dB)	η _c (%)	d _{im} (dBc)
CW, class-AB	2000	26	300	60	≥8.5	≥40	–
2-tone, class-AB	f ₁ = 2000.0 f ₂ = 2000.1	26	300	60 (PEP)	≥9	≥33	≤–30
CDMA, class-AB	2000	26	500	12.5	typ. 9	typ. 22	≤–46 ⁽¹⁾

Note

1. CDMA test signal with peak to average ratio of 11.9 dB. Adjacent Channel Power (ACP) is measured at ±885 kHz offset from the centre of the channel (2000 MHz) using a spectrum analyzer with the resolution set to 30 kHz.

Ruggedness in class-AB operation

The BLV2047 is capable of withstanding a load mismatch corresponding to VSWR = 3 : 1 through all phases under the following conditions: f₁ = 2000.0 MHz; f₂ = 2000.1 MHz; V_{CE} = 26 V; I_{CQ} = 300 mA; P_L = 60 W (PEP); T_{mb} = 25 °C.

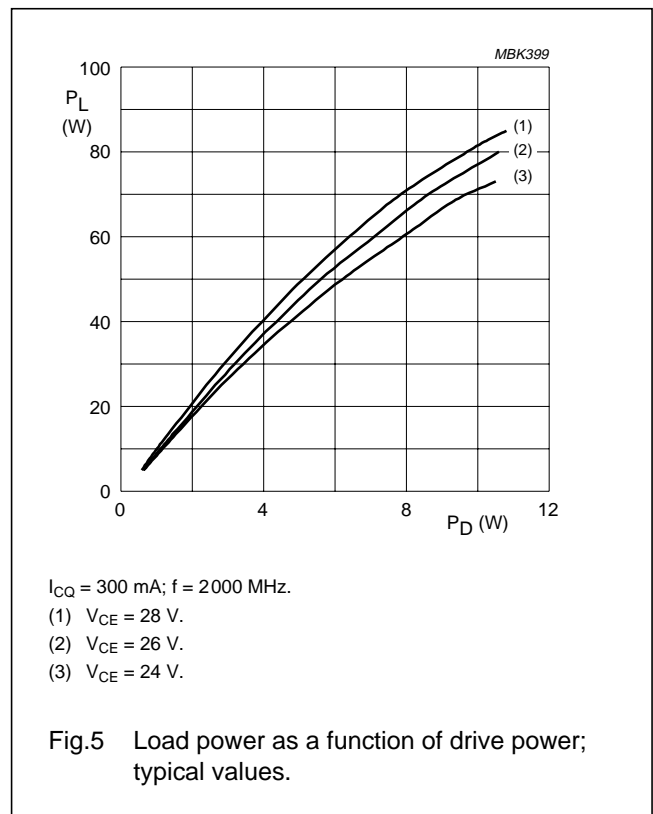
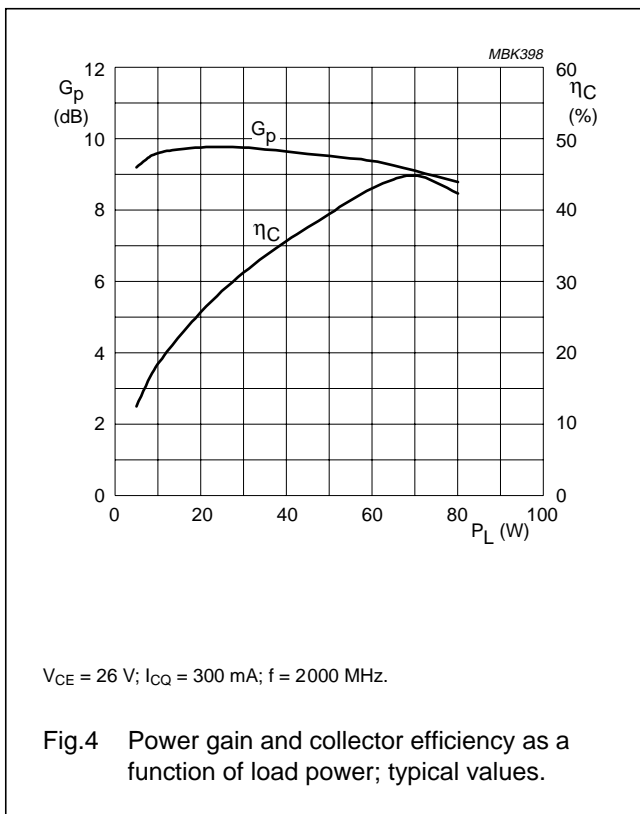

UHF power transistor

BLV2047

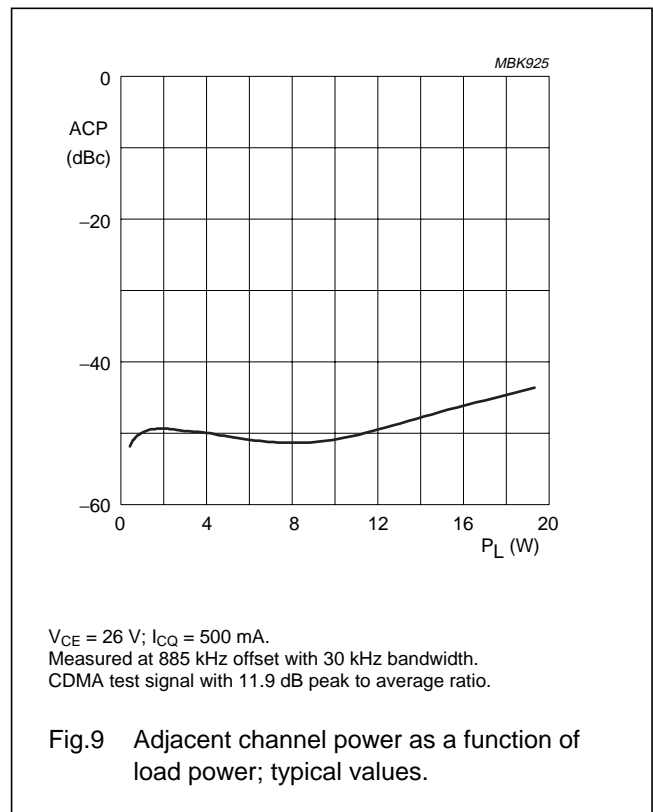
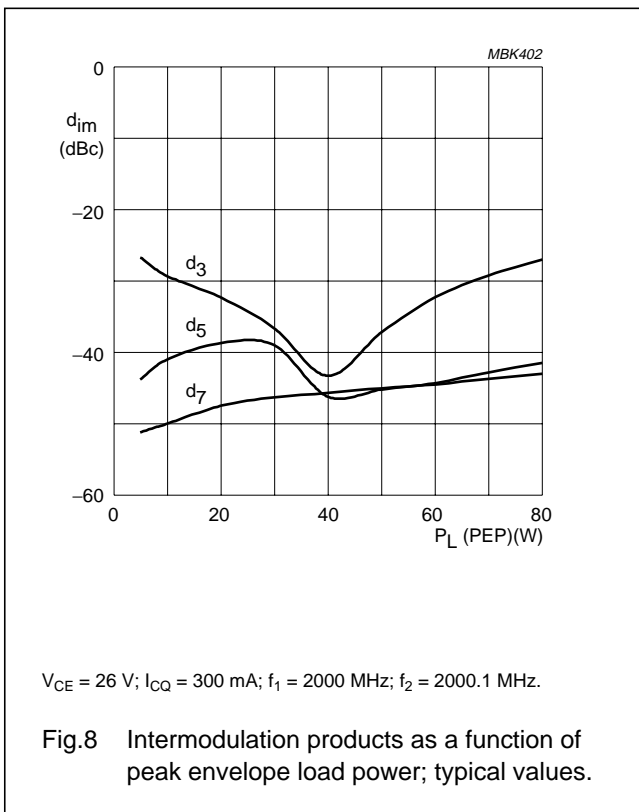
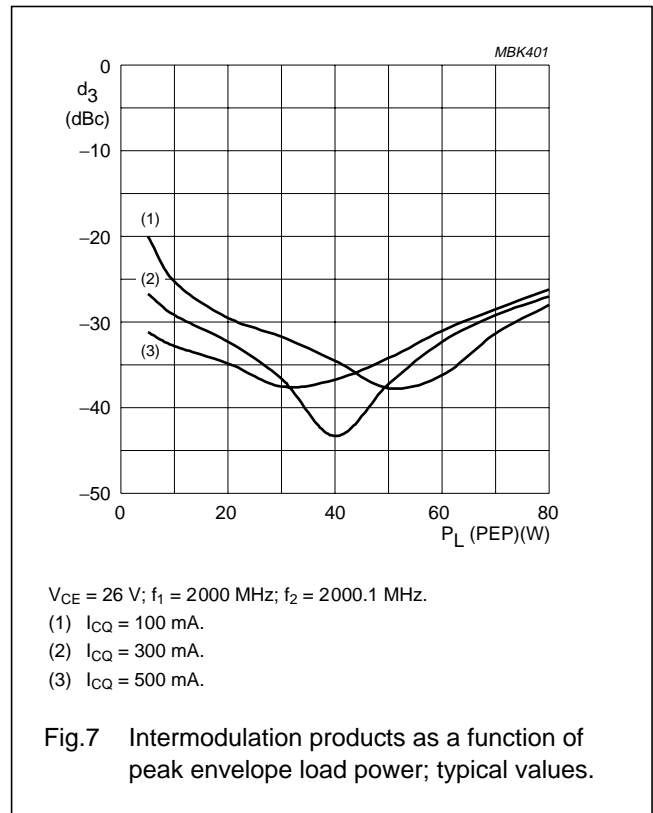
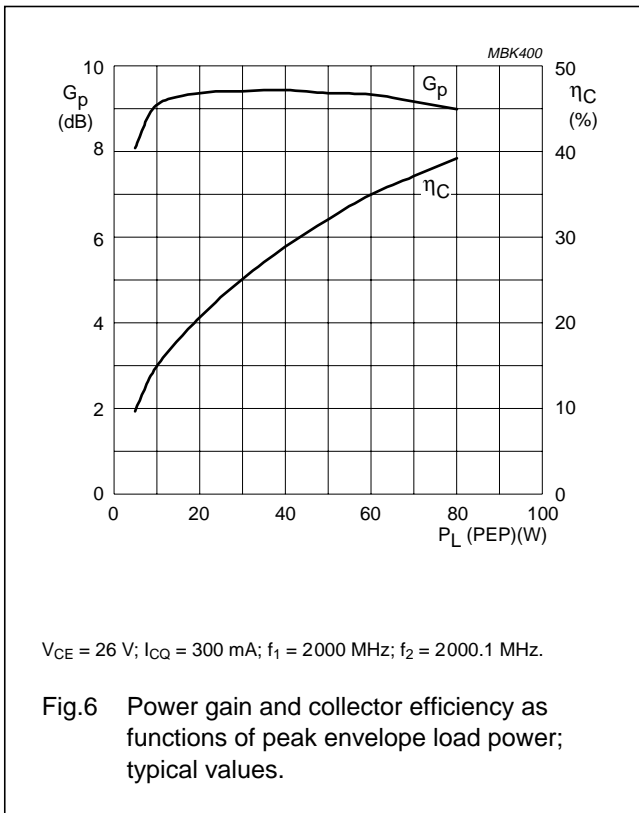

UHF power transistor

BLV2047

List of components (see Figs 10 and 11)

COMPONENT	DESCRIPTION	VALUE	DIMENSIONS	CATALOGUE NO.
C1, C8	multilayer ceramic chip capacitor; note 1	22 pF		
C2	Tekelec variable capacitor; type 37291	0.8 to 8 pF		
C3, C4	Tekelec variable capacitor; type 37271	0.6 to 4.5 pF		
C5	multilayer ceramic chip capacitor, note 2	22 pF		
C6, C12	tantalum SMD capacitor	10 μ F, 35 V		
C7	feedthrough capacitor	1.5 nF		
C9	multilayer ceramic chip capacitor, note 3	13 pF		
C10	multilayer ceramic chip capacitor, note 3	10 nF		
C11	feedthrough capacitor	3.3 nF		
L1	stripline; note 4	18.8 Ω	length 6.1 mm; width 3.9 mm	
L2	stripline; note 4	21.9 Ω	length 5 mm; width 3.2 mm	
L3	stripline; note 4	13 Ω	length 1.4 mm; width 6.1 mm	
L4	stripline; note 4	4.5 Ω	length 6.6 mm; width 20.2 mm	
L5, L14, L15	grade 4B1 ferroxcube chip-bead			4322 020 34420
L6	4 turns enamelled 1 mm copper wire	30 nH	int.dia. 3 mm; length 7 mm	
L7	stripline; note 4	7.3 Ω	length 4 mm; width 11.8 mm	
L8	stripline; note 4	6.8 Ω	length 4 mm; width 12.8 mm	
L9	stripline; note 4	43.7 Ω	length 12.5 mm; width 1 mm	
L10	stripline; note 4	5.6 Ω	length 8.5 mm; width 15.9 mm	
L11	stripline; note 4	18.8 Ω	length 1 mm; width 3.9 mm	
L12	stripline; note 4	53.3 Ω	length 3.4 mm; width 0.8 mm	
L13	stripline; note 4	17.4 Ω	length 6.5 mm; width 4.3 mm	
R1	standard chip resistor	10 Ω	type 0603	

Notes

1. American Technical Ceramics type 100A or capacitor of same quality.
2. American Technical Ceramics type 175B or capacitor of same quality.
3. American Technical Ceramics type 100B or capacitor of same quality.
4. The striplines are on a double copper-clad printed-circuit board with Teflon dielectric ($\epsilon_r = 6.15$); thickness 0.64 mm.

UHF power transistor

BLV2047

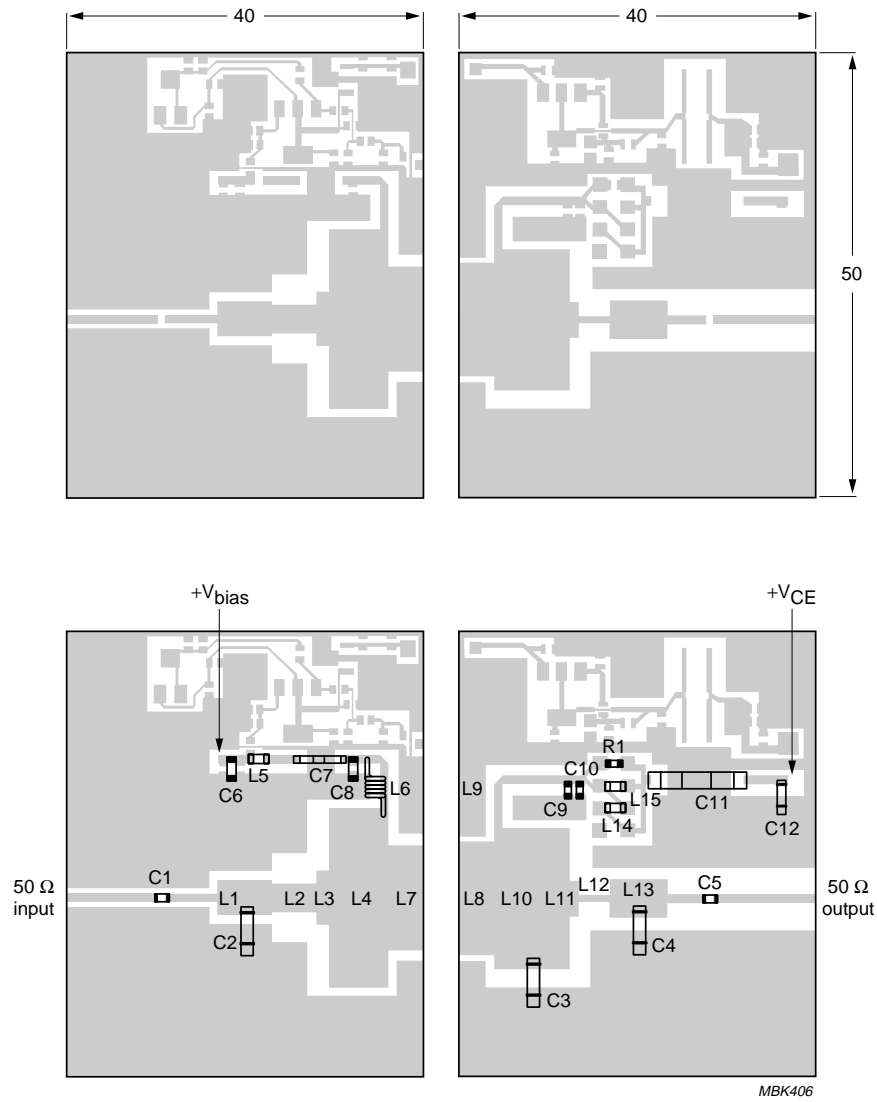

Dimensions in mm.

The components are situated on one side of the copper-clad Teflon board, the other side is unetched and serves as a ground plane. Earth connections from the component side to the ground plane are made by through metallization.

Fig.10 Component layout for 2000 MHz class-AB test circuit.

UHF power transistor

BLV2047

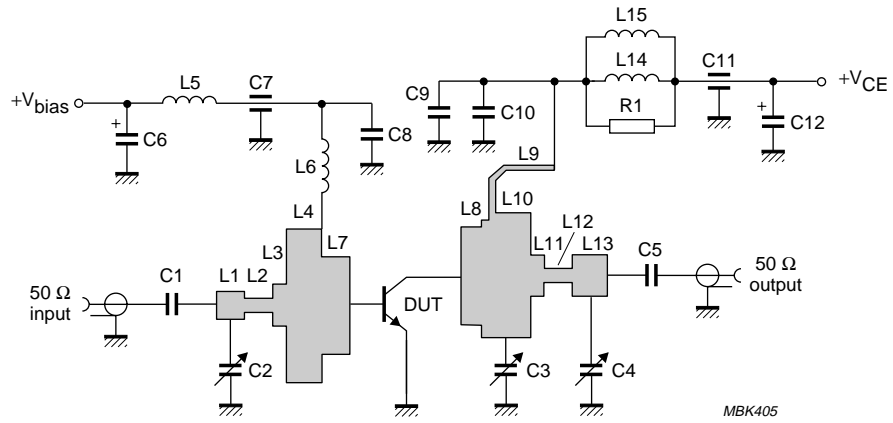

MBK405

For CDMA measurements:
 Replace L5, C7 and C11 by a bridging wire.
 Change L6 from 6 turns to 2 turns (same diameter).
 Add 4.7 μF, 50 V tantalum capacitor to C12.
 Add 100 pF ATC type 100A capacitor to C8.

Fig.11 Class-AB test circuit for 2000 MHz.

UHF power transistor

BLV2047

Scattering parameters: $V_{CE} = 26 \text{ V}$; $I_C = 1 \text{ A}$

f (MHz)	S ₁₁		S ₂₁		S ₁₂		S ₂₂	
	MAGNITUDE (ratio)	ANGLE (deg)	MAGNITUDE (ratio)	ANGLE (deg)	MAGNITUDE (ratio)	ANGLE (deg)	MAGNITUDE (ratio)	ANGLE (deg)
1500	0.982	173.3	0.169	131.8	0.031	106.4	0.967	174.6
1600	0.970	172.0	0.227	126.1	0.035	96.0	0.953	174.0
1700	0.947	170.4	0.349	114.3	0.037	93.3	0.929	173.8
1800	0.870	167.5	0.633	85.8	0.036	74.7	0.879	174.2
1850	0.779	169.9	0.838	59.5	0.034	60.4	0.845	178.0
1900	0.775	179.3	0.833	22.7	0.018	47.4	0.902	-177.4
1950	0.863	-178.0	0.644	-6.9	0.011	103.7	0.967	-178.7
2000	0.913	-179.4	0.456	-24.5	0.018	121.2	0.990	179.3
2100	0.950	178.0	0.285	-40.8	0.028	114.7	0.995	176.9
2200	0.955	176.4	0.190	-54.0	0.031	115.2	0.987	175.5
2300	0.955	175.0	0.145	-53.6	0.034	114.7	0.983	175.0
2400	0.948	173.7	0.162	-60.4	0.036	116.7	0.975	174.4
2500	0.937	172.4	0.143	-84.2	0.038	116.8	0.973	173.9

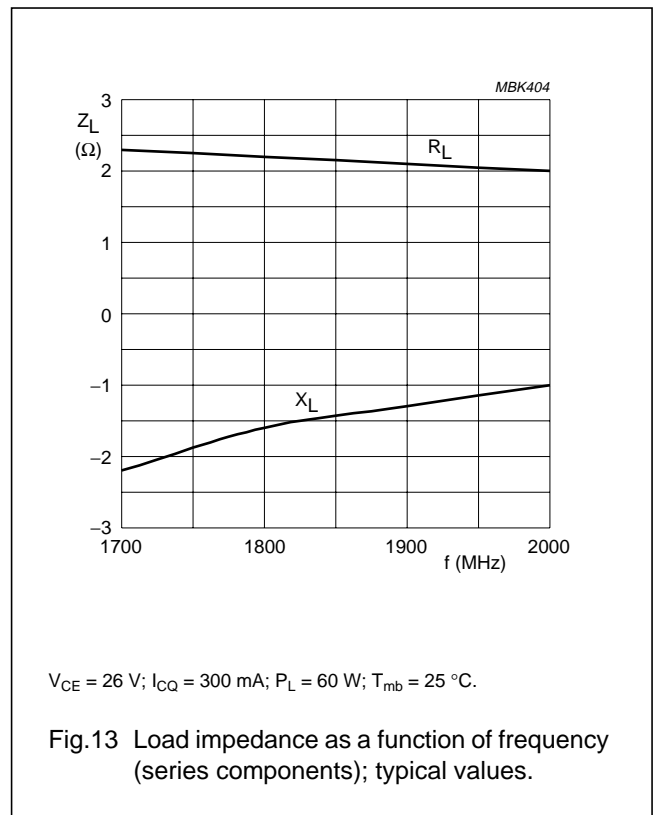
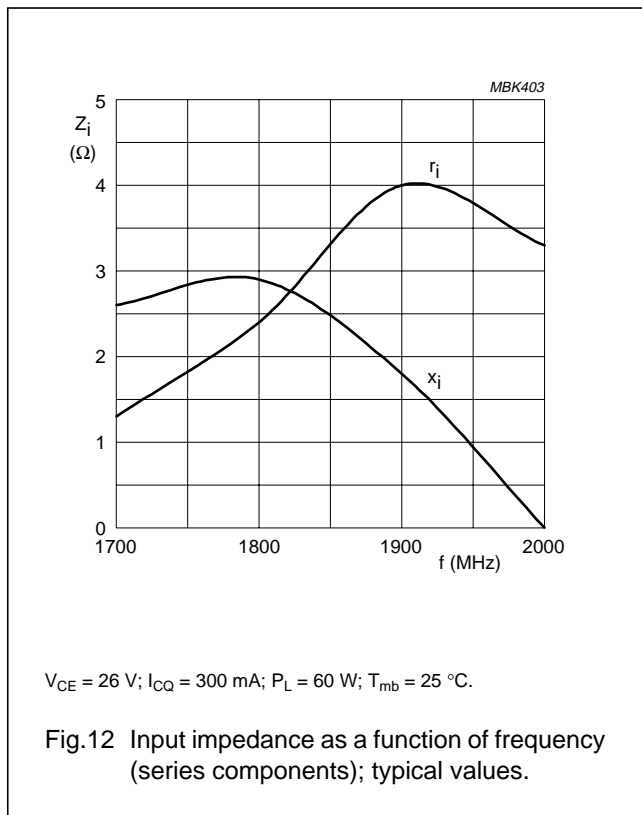

UHF power transistor

BLV2047

PACKAGE OUTLINE

Flanged ceramic (AlN) package; 2 mounting holes; 2 leads

SOT468A

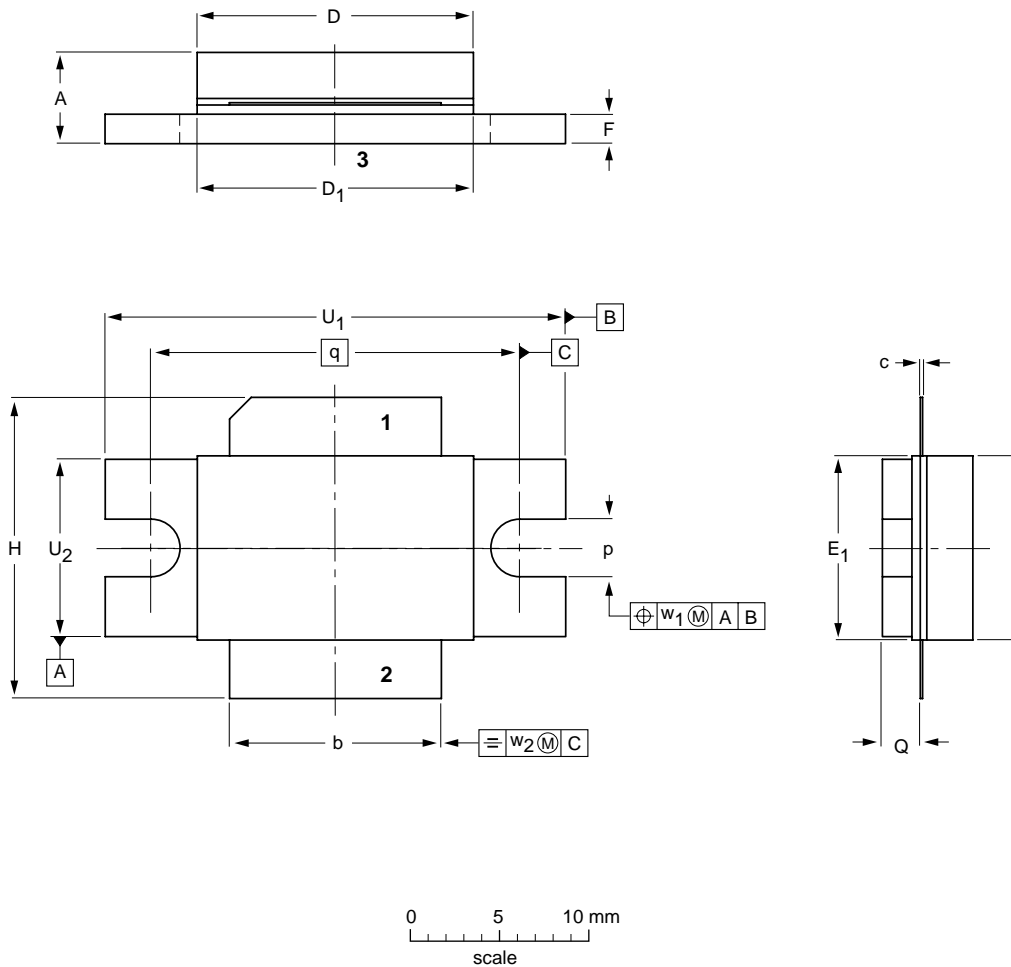

DIMENSIONS (millimetre dimensions are derived from the original inch dimensions)

UNIT	A	b	c	D	D ₁	E	E ₁	F	H	p	Q	q	U ₁	U ₂	w ₁	w ₂
mm	5.23 4.62	11.81 11.58	0.15 0.10	15.39 15,09	15.37 15,11	10.26 10.06	10.29 10.03	1.65 1.60	16.74 16.48	3.30 3.05	2.21 2.06	20.32	25.53 25.27	9.91 9.65	0.254	0.508
inches	0.206 0.182	0.465 0.455	0.006 0.004	0.606 0.594	0.605 0.595	0.404 0.396	0.405 0.395	0.065 0.063	0.659 0.649	0.130 0.120	0.087 0.081	0.800	1.005 0.995	0.390 0.380	0.01	0.02

OUTLINE VERSION	REFERENCES				EUROPEAN PROJECTION	ISSUE DATE
	IEC	JEDEC	EIAJ			
SOT468A						97-12-24

UHF power transistor

BLV2047

DEFINITIONS

Data Sheet Status	
Objective specification	This data sheet contains target or goal specifications for product development.
Preliminary specification	This data sheet contains preliminary data; supplementary data may be published later.
Product specification	This data sheet contains final product specifications.
Limiting values	
Limiting values given are in accordance with the Absolute Maximum Rating System (IEC 134). Stress above one or more of the limiting values may cause permanent damage to the device. These are stress ratings only and operation of the device at these or at any other conditions above those given in the Characteristics sections of the specification is not implied. Exposure to limiting values for extended periods may affect device reliability.	
Application information	
Where application information is given, it is advisory and does not form part of the specification.	

LIFE SUPPORT APPLICATIONS

These products are not designed for use in life support appliances, devices, or systems where malfunction of these products can reasonably be expected to result in personal injury. Philips customers using or selling these products for use in such applications do so at their own risk and agree to fully indemnify Philips for any damages resulting from such improper use or sale.

Philips Semiconductors – a worldwide company

Argentina: see South America

Australia: 34 Waterloo Road, NORTH RYDE, NSW 2113,
Tel. +61 2 9805 4455, Fax. +61 2 9805 4466

Austria: Computerstr. 6, A-1101 WIEN, P.O. Box 213,
Tel. +43 1 60 101 1248, Fax. +43 1 60 101 1210

Belarus: Hotel Minsk Business Center, Bld. 3, r. 1211, Volodarski Str. 6,
220050 MINSK, Tel. +375 172 20 0733, Fax. +375 172 20 0773

Belgium: see The Netherlands

Brazil: see South America

Bulgaria: Philips Bulgaria Ltd., Energoproject, 15th floor,
51 James Bourchier Blvd., 1407 SOFIA,
Tel. +359 2 68 9211, Fax. +359 2 68 9102

Canada: PHILIPS SEMICONDUCTORS/COMPONENTS,
Tel. +1 800 234 7381, Fax. +1 800 943 0087

China/Hong Kong: 501 Hong Kong Industrial Technology Centre,
72 Tat Chee Avenue, Kowloon Tong, HONG KONG,
Tel. +852 2319 7888, Fax. +852 2319 7700

Colombia: see South America

Czech Republic: see Austria

Denmark: Sydhavnsgade 23, 1780 COPENHAGEN V,
Tel. +45 33 29 3333, Fax. +45 33 29 3905

Finland: Sinikalliontie 3, FIN-02630 ESPOO,
Tel. +358 9 615 800, Fax. +358 9 6158 0920

France: 51 Rue Carnot, BP317, 92156 SURESNES Cedex,
Tel. +33 1 4099 6161, Fax. +33 1 4099 6427

Germany: Hammerbrookstraße 69, D-20097 HAMBURG,
Tel. +49 40 2353 60, Fax. +49 40 2353 6300

Hungary: see Austria

India: Philips INDIA Ltd, Band Box Building, 2nd floor,
254-D, Dr. Annie Besant Road, Worli, MUMBAI 400 025,
Tel. +91 22 493 8541, Fax. +91 22 493 0966

Indonesia: PT Philips Development Corporation, Semiconductors Division,
Gedung Philips, Jl. Buncit Raya Kav.99-100, JAKARTA 12510,
Tel. +62 21 794 0040 ext. 2501, Fax. +62 21 794 0080

Ireland: Newstead, Clonskeagh, DUBLIN 14,
Tel. +353 1 7640 000, Fax. +353 1 7640 200

Israel: RAPAC Electronics, 7 Kehilat Saloniki St, PO Box 18053,
TEL AVIV 61180, Tel. +972 3 645 0444, Fax. +972 3 649 1007

Italy: PHILIPS SEMICONDUCTORS, Piazza IV Novembre 3,
20124 MILANO, Tel. +39 02 67 52 2531, Fax. +39 02 67 52 2557

Japan: Philips Bldg 13-37, Kohnan 2-chome, Minato-ku,
TOKYO 108-8507, Tel. +81 3 3740 5130, Fax. +81 3 3740 5057

Korea: Philips House, 260-199 Itaewon-dong, Yongsan-ku, SEOUL,
Tel. +82 2 709 1412, Fax. +82 2 709 1415

Malaysia: No. 76 Jalan Universiti, 46200 PETALING JAYA, SELANGOR,
Tel. +60 3 750 5214, Fax. +60 3 757 4880

Mexico: 5900 Gateway East, Suite 200, EL PASO, TEXAS 79905,
Tel. +9-5 800 234 7381, Fax +9-5 800 943 0087

Middle East: see Italy

Netherlands: Postbus 90050, 5600 PB EINDHOVEN, Bldg. VB,
Tel. +31 40 27 82785, Fax. +31 40 27 88399

New Zealand: 2 Wagener Place, C.P.O. Box 1041, AUCKLAND,
Tel. +64 9 849 4160, Fax. +64 9 849 7811

Norway: Box 1, Manglerud 0612, OSLO,
Tel. +47 22 74 8000, Fax. +47 22 74 8341

Pakistan: see Singapore

Philippines: Philips Semiconductors Philippines Inc.,
106 Valero St. Salcedo Village, P.O. Box 2108 MCC, MAKATI,
Metro MANILA, Tel. +63 2 816 6380, Fax. +63 2 817 3474

Poland: Ul. Lukiska 10, PL 04-123 WARSZAWA,
Tel. +48 22 612 2831, Fax. +48 22 612 2327

Portugal: see Spain

Romania: see Italy

Russia: Philips Russia, Ul. Usatcheva 35A, 119048 MOSCOW,
Tel. +7 095 755 6918, Fax. +7 095 755 6919

Singapore: Lorong 1, Toa Payoh, SINGAPORE 319762,
Tel. +65 350 2538, Fax. +65 251 6500

Slovakia: see Austria

Slovenia: see Italy

South Africa: S.A. PHILIPS Pty Ltd., 195-215 Main Road Martindale,
2092 JOHANNESBURG, P.O. Box 58088 Newville 2114,
Tel. +27 11 471 5401, Fax. +27 11 471 5398

South America: Al. Vicente Pinzon, 173, 6th floor,
04547-130 SÃO PAULO, SP, Brazil,
Tel. +55 11 821 2333, Fax. +55 11 821 2382

Spain: Balmes 22, 08007 BARCELONA,
Tel. +34 93 301 6312, Fax. +34 93 301 4107

Sweden: Kottbygatan 7, Akalla, S-16485 STOCKHOLM,
Tel. +46 8 5985 2000, Fax. +46 8 5985 2745

Switzerland: Allmendstrasse 140, CH-8027 ZÜRICH,
Tel. +41 1 488 2741 Fax. +41 1 488 3263

Taiwan: Philips Semiconductors, 6F, No. 96, Chien Kuo N. Rd., Sec. 1,
TAIPEI, Taiwan Tel. +886 2 2134 2886, Fax. +886 2 2134 2874

Thailand: PHILIPS ELECTRONICS (THAILAND) Ltd.,
209/2 Sanpavuth-Bangna Road Prakanong, BANGKOK 10260,
Tel. +66 2 745 4090, Fax. +66 2 398 0793

Turkey: Yukari Dudullu, Org. San. Blg., 2.Cad. Nr. 28 81260 Umraniye,
ISTANBUL, Tel. +90 216 522 1500, Fax. +90 216 522 1813

Ukraine: PHILIPS UKRAINE, 4 Patrice Lumumba str., Building B, Floor 7,
252042 KIEV, Tel. +380 44 264 2776, Fax. +380 44 268 0461

United Kingdom: Philips Semiconductors Ltd., 276 Bath Road, Hayes,
MIDDLESEX UB3 5BX, Tel. +44 181 730 5000, Fax. +44 181 754 8421

United States: 811 East Arques Avenue, SUNNYVALE, CA 94088-3409,
Tel. +1 800 234 7381, Fax. +1 800 943 0087

Uruguay: see South America

Vietnam: see Singapore

Yugoslavia: PHILIPS, Trg N. Pasica 5/v, 11000 BEOGRAD,
Tel. +381 11 62 5344, Fax. +381 11 63 5777

For all other countries apply to: Philips Semiconductors,
International Marketing & Sales Communications, Building BE-p, P.O. Box 218,
5600 MD EINDHOVEN, The Netherlands, Fax. +31 40 27 24825

Internet: <http://www.semiconductors.philips.com>

© Philips Electronics N.V. 1999

SCA 65

All rights are reserved. Reproduction in whole or in part is prohibited without the prior written consent of the copyright owner.

The information presented in this document does not form part of any quotation or contract, is believed to be accurate and reliable and may be changed without notice. No liability will be accepted by the publisher for any consequence of its use. Publication thereof does not convey nor imply any license under patent- or other industrial or intellectual property rights.

Printed in The Netherlands

125002/06/pp12

Date of release: 1999 Jun 09

Document order number: 9397 750 05856

Let's make things better.

**Philips
Semiconductors**



PHILIPS