

**2A, 60V, 0.950 Ohm, Logic Level,  
N-Channel Power MOSFET**

The RFL2N06L N-channel enhancement mode silicon gate power field effect transistor is designed for applications such as switching regulators, switching converters, motor drivers, relay drivers and drivers for high power bipolar switching transistors requiring high speed and low gate drive power. These types can be operated directly from integrated circuits.

Formerly developmental type TA9520.

**Ordering Information**

PART NUMBER	PACKAGE	BRAND
RFL2N06L	TO-205AF	RFL2N06L

NOTE: When ordering, use the entire part number.

**Features**

- 2A, 50V and 60V
- $r_{DS(ON)} = 0.950\Omega$
- Design Optimized for 5V Gate Drives
- Can be Driven from QMOS, NMOS, TTL Circuits
- Compatible with Automotive Drive Requirements
- SOA is Power Dissipation Limited
- Nanosecond Switching Speeds
- Linear Transfer Characteristics
- High Input Impedance
- Majority Carrier Device

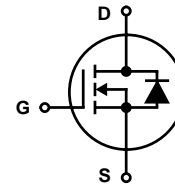
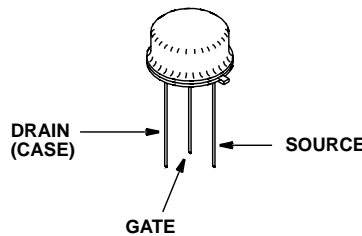
**Symbol**

**Packaging**
**JEDEC TO-205AF**

## RFL2N06L

### Absolute Maximum Ratings $T_C = 25^\circ\text{C}$ , Unless Otherwise Specified

	RFL2N06L	UNITS
Drain to Source Voltage (Note 1) . . . . .	50	V
Drain to Gate Voltage ( $R_{GS} = 20\text{K}\Omega$ ) (Note 1) . . . . .	60	V
Continuous Drain Current . . . . .	2	A
Pulsed Drain Current (Note 3) . . . . .	10	A
Gate to Source Voltage . . . . .	$\pm 10$	V
Maximum Power Dissipation . . . . .	8.33	W
Above $T_C = 25^\circ\text{C}$ , Derate Linearly . . . . .	0.0667	W/ $^\circ\text{C}$
Operating and Storage Temperature . . . . .	-55 to 150	$^\circ\text{C}$
Maximum Temperature for Soldering		
Leads at 0.063in (1.6mm) from Case for 10s . . . . .	300	$^\circ\text{C}$

*CAUTION: Stresses above those listed in "Absolute Maximum Ratings" may cause permanent damage to the device. This is a stress only rating and operation of the device at these or any other conditions above those indicated in the operational sections of this specification is not implied.*

**NOTE:**

1.  $T_J = 25^\circ\text{C}$  to  $125^\circ\text{C}$ .

### Electrical Specifications $T_C = 25^\circ\text{C}$ , Unless Otherwise Specified

PARAMETER	SYMBOL	TEST CONDITIONS	MIN	TYP	MAX	UNITS
Drain to Source Breakdown Voltage	$BV_{DSS}$	$I_D = 250\mu\text{A}$ , $V_{GS} = 0\text{V}$	60	-	-	V
Gate Threshold Voltage	$V_{GS(TH)}$	$V_{GS} = V_{DS}$ , $I_D = 250\mu\text{A}$ , (Figure 8)	1	-	2	V
Zero Gate Voltage Drain Current	$IDSS$	$V_{DS} = \text{Rated } BV_{DSS}$ , $V_{GS} = 0\text{V}$	-	-	1	$\mu\text{A}$
		$V_{DS} = 0.8 \times \text{Rated } BV_{DSS}$ , $V_{GS} = 0\text{V}$ , $T_C = 125^\circ\text{C}$	-	-	25	$\mu\text{A}$
Gate to Source Leakage Current	$I_{GSS}$	$V_{GS} = \pm 10\text{V}$ , $V_{DS} = 0\text{V}$	-	-	$\pm 100$	nA
Drain to Source On Voltage (Note 2)	$V_{DS(ON)}$	$I_D = 2\text{A}$ , $V_{GS} = 5\text{V}$	-	-	1.9	V
Drain to Source On Resistance (Note 2)	$r_{DS(ON)}$	$I_D = 2\text{A}$ , $V_{GS} = 5\text{V}$ , (Figures 6, 7)	-	-	0.950	$\Omega$
Turn-On Delay Time	$t_{d(ON)}$	$I_D = 2\text{A}$ , $V_{DD} = 30\text{V}$ , $R_G = 6.25\Omega$ , $R_L = 30\Omega$ $V_{GS} = 5\text{V}$ , (Figures 10, 11, 12)	-	10	20	ns
Rise Time	$t_r$		-	65	130	ns
Turn-Off Delay Time	$t_{d(OFF)}$		-	20	40	ns
Fall Time	$t_f$		-	30	60	ns
Input Capacitance	$C_{ISS}$	$V_{GS} = 0\text{V}$ , $V_{DS} = 25\text{V}$ , $f = 1\text{MHz}$ , (Figure 9)	-	-	225	pF
Output Capacitance	$C_{OSS}$		-	-	100	pF
Reverse Transfer Capacitance	$C_{RSS}$		-	-	40	pF
Thermal Resistance Junction to Case	$R_{\theta JC}$		-	-	15	$^\circ\text{C/W}$

### Source to Drain Diode Specifications

PARAMETER	SYMBOL	TEST CONDITIONS	MIN	TYP	MAX	UNITS
Source to Drain Diode Voltage (Note 2)	$V_{SD}$	$I_{SD} = 2\text{A}$	-	-	1.4	V
Diode Reverse Recovery Time	$t_{rr}$	$I_{SD} = 2\text{A}$ , $dI_{SD}/dt = 100\text{A}/\mu\text{s}$	-	150	-	ns

**NOTES:**

2. Pulse test: pulse width  $\leq 300\mu\text{s}$ , duty cycle  $\leq 2\%$ .
3. Repetitive rating: pulse width limited by maximum junction temperature.

Typical Performance Curves Unless Otherwise Specified

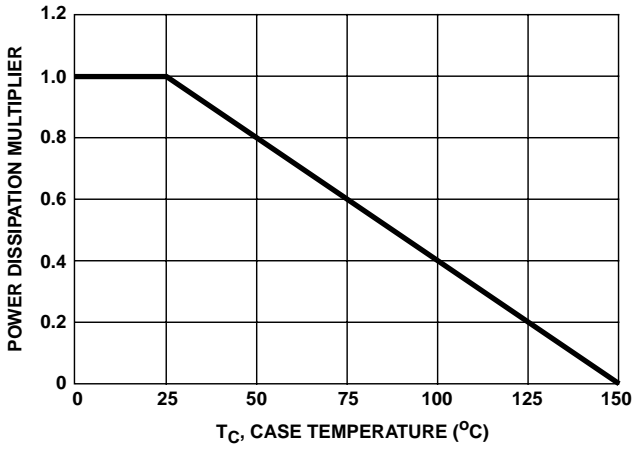

FIGURE 1. NORMALIZED POWER DISSIPATION vs CASE TEMPERATURE

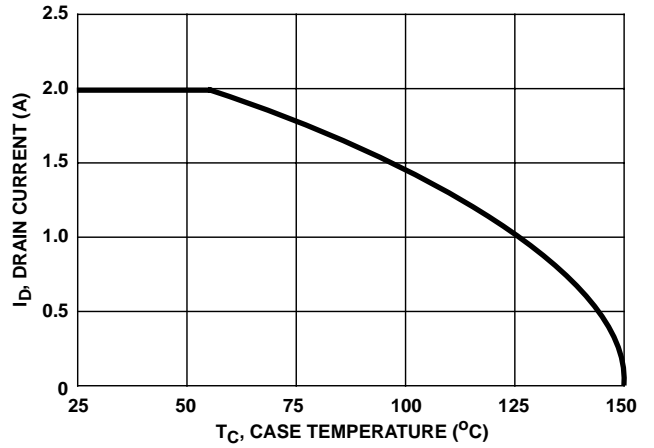

FIGURE 2. MAXIMUM CONTINUOUS DRAIN CURRENT vs CASE TEMPERATURE

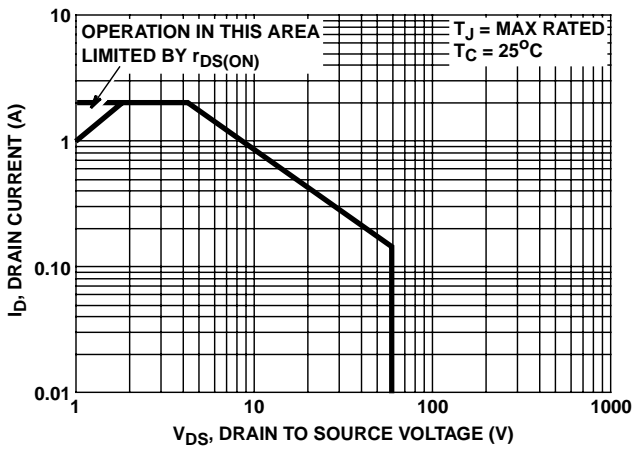

FIGURE 3. FORWARD BIAS SAFE OPERATING AREA

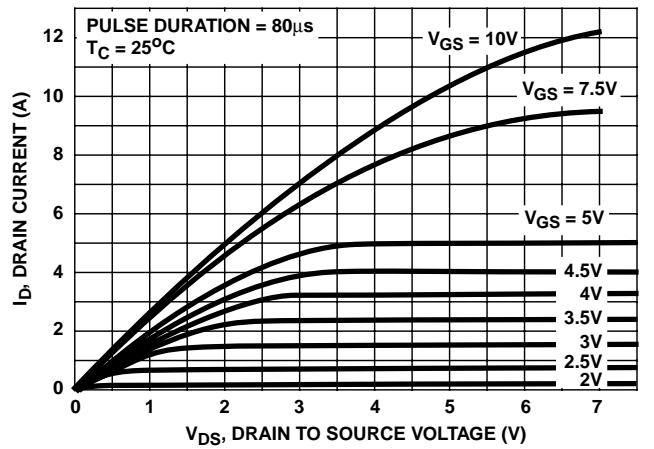

FIGURE 4. SATURATION CHARACTERISTICS

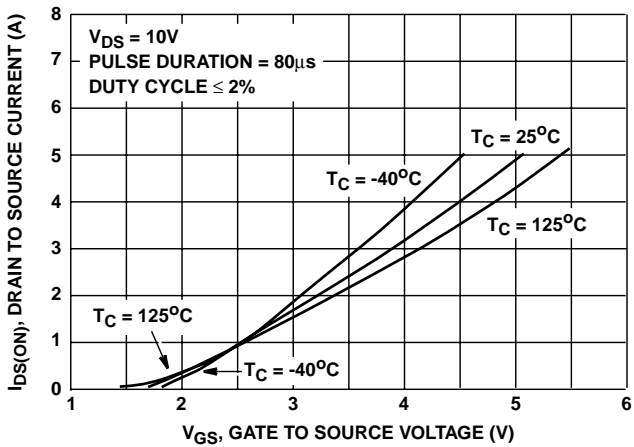

FIGURE 5. TRANSFER CHARACTERISTICS

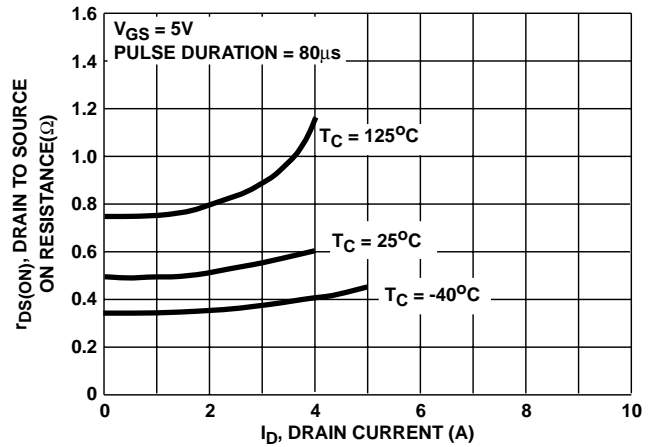

FIGURE 6. DRAIN TO SOURCE ON RESISTANCE vs DRAIN CURRENT

**Typical Performance Curves** Unless Otherwise Specified (Continued)

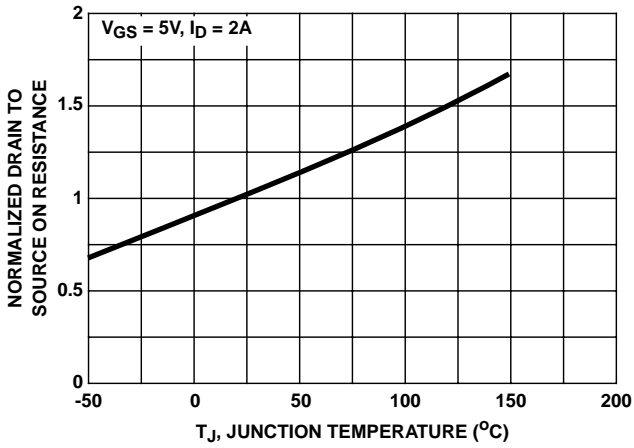

FIGURE 7. NORMALIZED DRAIN TO SOURCE ON RESISTANCE vs JUNCTION TEMPERATURE

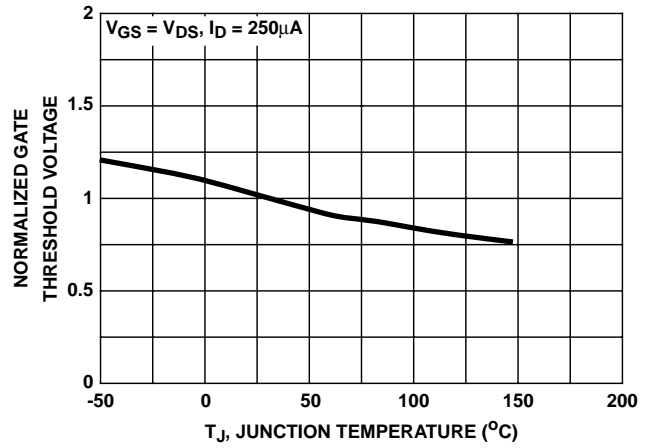

FIGURE 8. NORMALIZED GATE THRESHOLD VOLTAGE vs JUNCTION TEMPERATURE

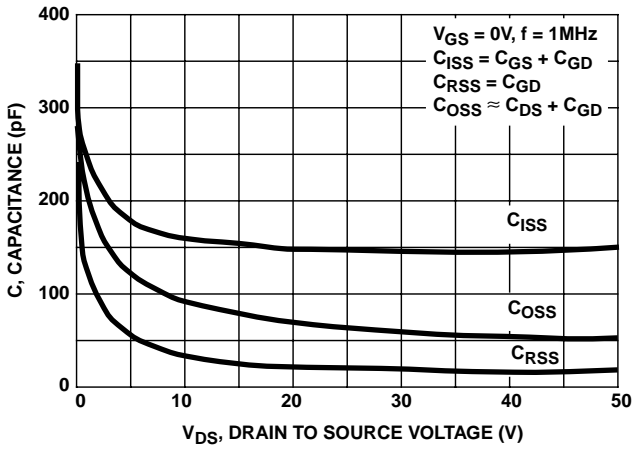
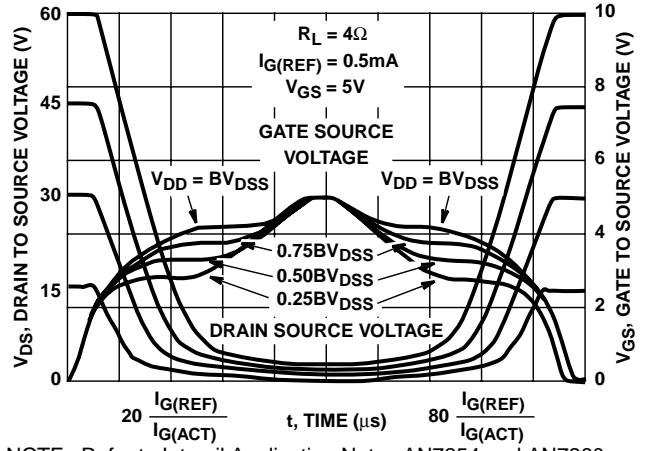

FIGURE 9. CAPACITANCE vs DRAIN TO SOURCE VOLTAGE



NOTE: Refer to Intersil Application Notes AN7254 and AN7260.

FIGURE 10. NORMALIZED SWITCHING WAVEFORMS FOR CONSTANT GATE CURRENT

**Test Circuits and Waveforms**

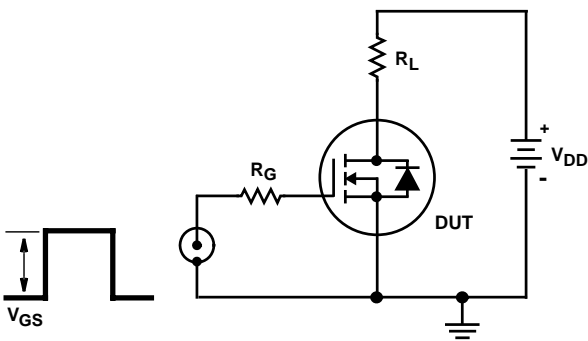

FIGURE 11. SWITCHING TIME TEST CIRCUIT

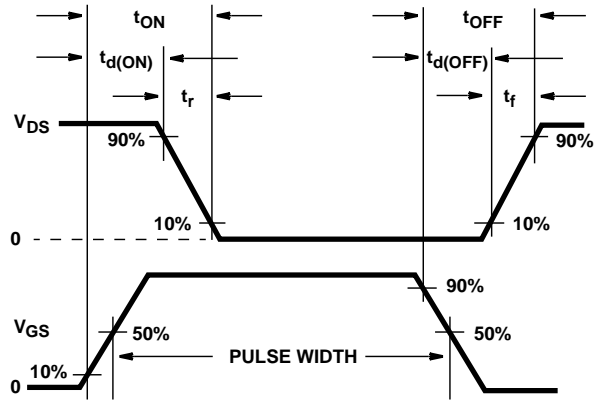

FIGURE 12. RESISTIVE SWITCHING WAVEFORMS

All Intersil semiconductor products are manufactured, assembled and tested under **ISO9000** quality systems certification.

*Intersil semiconductor products are sold by description only. Intersil Corporation reserves the right to make changes in circuit design and/or specifications at any time without notice. Accordingly, the reader is cautioned to verify that data sheets are current before placing orders. Information furnished by Intersil is believed to be accurate and reliable. However, no responsibility is assumed by Intersil or its subsidiaries for its use; nor for any infringements of patents or other rights of third parties which may result from its use. No license is granted by implication or otherwise under any patent or patent rights of Intersil or its subsidiaries.*

For information regarding Intersil Corporation and its products, see web site [www.intersil.com](http://www.intersil.com)

### **Sales Office Headquarters**

#### **NORTH AMERICA**

Intersil Corporation  
P. O. Box 883, Mail Stop 53-204  
Melbourne, FL 32902  
TEL: (407) 724-7000  
FAX: (407) 724-7240

#### **EUROPE**

Intersil SA  
Mercure Center  
100, Rue de la Fusee  
1130 Brussels, Belgium  
TEL: (32) 2.724.2111  
FAX: (32) 2.724.22.05

#### **ASIA**

Intersil (Taiwan) Ltd.  
7F-6, No. 101 Fu Hsing North Road  
Taipei, Taiwan  
Republic of China  
TEL: (886) 2 2716 9310  
FAX: (886) 2 2715 3029