



SANYO Semiconductors

DATA SHEET

LA7358M

Monolithic Linear IC

For VCR

SECAM Chroma Signal Processor

Overview

LA7358M is a VCR-use SECAM chroma signal processor.

Function

- 4.3MHz BPF
- 1.1MHz BPF
- Limiter
- AGC (in PB mode)
- Divide-by-four circuit
- 4×circuit
- 2.2MHz BPF
- Automatic adjustment BELL filter
- SECAM detector
- Sync gate

Specifications

Maximum Ratings at $T_a = 25^\circ\text{C}$

Parameter	Symbol	Conditions	Ratings	Unit
Maximum supply voltage	$V_{CC \text{ max}}$		7.0	V
Allowable power dissipation	$P_d \text{ max}$	$T_a \leq 70^\circ\text{C}^*$	600	mW
Operating temperature	T_{opr}		-15 to +70	$^\circ\text{C}$
Storage temperature	T_{stg}		-40 to +150	$^\circ\text{C}$

* Mounted on a board. $114.3 \times 76.1 \times 1.6 \text{ mm}^3$ Glass epoxy

Operating Conditions at $T_a = 25^\circ\text{C}$

Parameter	Symbol	Conditions	Ratings	Unit
Recommended supply voltage	V_{CC}		5.0	V
Operating supply voltage range	$V_{CC \text{ op}}$		4.8 to 5.5	V

■ Any and all SANYO Semiconductor products described or contained herein do not have specifications that can handle applications that require extremely high levels of reliability, such as life-support systems, aircraft's control systems, or other applications whose failure can be reasonably expected to result in serious physical and/or material damage. Consult with your SANYO Semiconductor representative nearest you before using any SANYO Semiconductor products described or contained herein in such applications.

■ SANYO Semiconductor assumes no responsibility for equipment failures that result from using products at values that exceed, even momentarily, rated values (such as maximum ratings, operating condition ranges, or other parameters) listed in products specifications of any and all SANYO Semiconductor products described or contained herein.

SANYO Semiconductor Co., Ltd.

TOKYO OFFICE Tokyo Bldg., 1-10, 1 Chome, Ueno, Taito-ku, TOKYO, 110-8534 JAPAN

LA7358M

Electrical Characteristics $T_a = 25^\circ\text{C}$, $V_{CC} = 5\text{V}$

Parameter	Symbol	Input	Test point	Conditions	Ratings			Unit
					min	typ	max	
REC mode current drain	I_{CCR}	S16	A23	$V_5 = 0\text{V}$, $V_{17} = 0\text{V}$, S29 = Comp.Sync S16 = Color bar signal (Fig.1)	50	70	90	mA
4.3MHz BPF characteristics (1)	VF4C	S16	T18	$V_5 = 5\text{V}$, $V_{17} = 0\text{V}$, S29 = Comp.Sync S16 = sine wave (200mVp-p, $f = 4.286\text{MHz}$)	145	180	215	mVp-p
4.3MHz BPF characteristics (2)	GF4L1	S16	T18	$V_5 = 5\text{V}$, $V_{17} = 0\text{V}$, S29 = Comp.Sync S16 = sine wave (200mVp-p, $f = 1.1\text{MHz}$) referenced (0dB) to VF4C.		-30	-20	dB
4.3MHz BPF characteristics (3)	GF4L2	S16	T18	$V_5 = 5\text{V}$, $V_{17} = 0\text{V}$, S29 = Comp.Sync S16 = sine wave (200mVp-p, $f = 2.2\text{MHz}$) referenced (0dB) to VF4C.		-10	-5	dB
4.3MHz BPF characteristics (4)	GF4H	S16	T18	$V_5 = 5\text{V}$, $V_{17} = 0\text{V}$, S29 = Comp.Sync S16 = sine wave (200mVp-p, $f = 7.5\text{MHz}$) referenced (0dB) to VF4C.		-30	-20	dB
REC BELL center frequency	FBLR1	S16	T22	$V_5 = 0\text{V}$, $V_{17} = 0\text{V}$, SW22B = ON S16 = sine wave (200mVp-p, $f = 4$ to 5MHz) S29 = Comp.Sync (Note1)	4.243	4.286	4.329	MHz
REC BELL characteristics (1)	VBLRC	S16	T22	$V_5 = 0\text{V}$, $V_{17} = 0\text{V}$, SW22B = ON S16 = sine wave (200mVp-p, $f = \text{FBLR1}$) S29 = Comp.Sync	200	250	300	mVp-p
REC BELL characteristics (2)	GBLRL	S16	T22	$V_5 = 0\text{V}$, $V_{17} = 0\text{V}$, SW22B = ON S16 = sine wave (200mVp-p, $f = 3.8\text{MHz}$) referenced (0dB) to VBLRC.	-14	-11	-8	dB
REC BELL characteristics (3)	GBLRH	S16	T22	$V_5 = 0\text{V}$, $V_{17} = 0\text{V}$, SW22B = ON S16 = sine wave (200mVp-p, $f = 4.8\text{MHz}$) referenced (0dB) to VBLRC.	-14	-11	-8	dB
REC mode killer operation level	GKLR	S16	T28	$V_5 = 0\text{V}$, $V_{17} = 0\text{V}$, SW22B = ON, $V_{25} = 3.4\text{V}$, $V_{26} = 3.7\text{V}$ S16 = SECAM color bar signal (level variable) S29 = Comp.Sync (Note2)	-28	-23	-18	dB
REC EQ center frequency	FEQR1	S22	T12	SW1 = ON, $V_1 = 5\text{V}$, $V_5 = 0\text{V}$, $V_{17} = 0\text{V}$ S22 = sine wave (200mVp-p, $f = 4$ to 5MHz) SW22A = SW22B = ON, S29 = Comp.Sync (Note3)	1.0608	1.0715	1.0822	MHz
REC EQ characteristics (1)	VEQRC	S22	T12	SW1 = ON, $V_1 = 5\text{V}$, $V_5 = 0\text{V}$, $V_{17} = 0\text{V}$ S22 = sine wave (200mVp-p, $f = \text{FEQR1} \times 4$) SW22A = SW22B = ON, S29 = Comp.Sync	65	85	105	mVp-p

Continued on next page.

LA7358M

Continued from preceding page.

Parameter	Symbol	Input	Test point	Conditions	Ratings			Unit
					min	typ	max	
REC EQ characteristics (2)	GEQRL	S22	T12	SW1 = ON, V1 = 5V, V5 = 0V, V17 = 0V S22 = sine wave (200mVp-p, f = 3.8MHz) referenced (0dB) to VEQRC. SW22A = SW22B = ON, S29 = Comp.Sync	8	11	14	dB
REC EQ characteristics (3)	GEQRH	S22	T12	SW1 = ON, V1 = 5V, V5 = 0V, V17 = 0V S22 = sine wave (200mVp-p, f = 4.8MHz) referenced (0dB) to VEQRC. SW22A = SW22B = ON, S29 = Comp.Sync	8	11	14	dB
REC chroma signal output level	VOR	S16	T12	SW1 = ON, V1 = 5V, V5 = 0V, V17 = 0V S22 = sine wave (200mVp-p, f = 4.4MHz) SW22B = ON, S29 = Comp.Sync	80	110	140	mVp-p
REC chroma signal output unwanted spectrum (1)	GSR1	S16	T12	SW1 = ON, V1 = 5V, V5 = 0V, V17 = 0V S22 = sine wave (200mVp-p, f = 4.4MHz) SW22B = ON, S29 = Comp.Sync Measure 2.2MHz component at T12. Referenced (0dB) to VOR.		-30	-20	dB
REC chroma signal output unwanted spectrum (2)	GSR2	S16	T12	SW1 = ON, V1 = 5V, V5 = 0V, V17 = 0V S22 = sine wave (200mVp-p, f = 4.4MHz) SW22B = ON, S29 = Comp.Sync Measure 3.3MHz component at T12. Referenced (0dB) to VOR.		-30	-20	dB
PB mode current drain	I _{CCP}	S14	A23	V5 = 0V, V17 = 5V, S29 = Comp.Sync S14 = sine wave (50mVp-p, f = 1.0715MHz)	60	80	100	mA
AGC control characteristics (1)	VAGC	S14	T12	V6 = 5V, SW9B = ON, V17 = 5V, S29 = Comp.Sync S14 = sine wave (50mVp-p, f = 1.0715MHz)	90	120	150	mVp-p
AGC control characteristics (2)	GAGC1	S14	T12	V6 = 5V, SW9B = ON, V17 = 5V, S29 = Comp.Sync S14 = sine wave (100mVp-p, f = 1.0715MHz) referenced (0dB) to VAGC.	-1	0	1	dB
AGC control characteristics (3)	GAGC2	S14	T12	V6 = 5V, SW9B = ON, V17 = 5V, S29 = Comp.Sync S14 = sine wave (25mVp-p, f = 1.0715MHz) referenced (0dB) to VAGC.	-1	0	1	dB
1.1MHz BPF characteristics (1)	GF1L	S14	T12	V6 = 5V, SW15 = ON, V15 = V15R (Note4) S14 = sine wave (50mVp-p, f = 500kHz), V17 = 5V S29 = Comp.Sync, referenced (0dB) to VAGC.	-3	0	3	dB
1.1MHz BPF characteristics (2)	GF1H1	S14	T12	V6 = 5V, SW15 = ON, V15 = V15R (Note4) S14 = sine wave (50mVp-p, f = 2.2kHz), referenced (0dB) to VAGC. V17 = 5V, S29 = Comp.Sync		-30	-20	dB

Continued on next page.

LA7358M

Continued from preceding page.

Parameter	Symbol	Input	Test point	Conditions	Ratings			Unit
					min	typ	max	
1.1MHz BPF characteristics (3)	GF1H2	S14	T12	V6 = 5V, SW15 = ON, V15 = V15R(Note4) S14 = sine wave (50mVp-p, f = 3.3kHz), referenced (0dB) to VAGC. V17 = 5V, S29 = Comp.Sync		-35	-25	dB
PB EQ centre frequency	FEQP1	S14	T9	V6 = 0V, SW9B = ON, SW15 = ON, V15 = V15R (Note4), V17 = 5V S14 = sine wave (50mVp-p, f = 1 to 1.2MHz) S29 = Comp.Sync (Note5)	1.0608	1.0715	1.0822	MHz
PB EQ characteristics (1)	VEQPC	S14	T9	V6 = 0V, SW9B = ON, SW15 = ON, V15 = V15R (Note4), V17 = 5V S14 = sine wave (50mVp-p, f = FEQP1) S29 = Comp.Sync	120	150	180	mVp-p
PB EQ characteristics (2)	GEQPL	S14	T9	V6 = 0V, SW9B = ON, SW15 = ON, V15 = V15R (Note4), V17 = 5V S14 = sine wave (50mVp-p, f = 950kHz), referenced (0dB) to VEQP. S29 = Comp.Sync	-14	-11	-8	dB
PB EQ characteristics (3)	GEQPH	S14	T9	V6 = 0V, SW9B = ON, SW15 = ON, V15 = V15R (Note4), V17 = 5V S14 = sine wave (50mVp-p, f = 1.2kHz), referenced (0dB) to VEQP. S29 = Comp.Sync	-14	-11	-8	dB
PB BELL centre frequency	FBLP1	S9	T18	SW1 = ON, V1 = 5V, V5 = 0V, SW9A = SW9B = ON, V17 = 5V S29 = Comp.Sync S9 = sine wave (200mVp-p, f = 1 to 1.2MHz) (Note6)	4.243	4.286	4.329	MHz
PB BELL characteristics (1)	VBLPC	S9	T18	SW1 = ON, V1 = 5V, V5 = 0V, SW9A = SW9B = ON, V17 = 5V S10 = sine wave (200mVp-p, f = FBLP1×1/4) S29 = Comp.Sync	65	85	105	mVp-p
PB BELL characteristics (2)	GBLPL	S9	T18	SW1 = ON, V1 = 5V, V5 = 0V, SW9A = SW9B = ON, V17 = 5V S9 = sine wave (200mVp-p, f = 950kHz), referenced (0dB) to VBLPC. S29 = Comp.Sync	8	11	14	dB
PB BELL characteristics (3)	GBLPH	S9	T18	SW1 = ON, V1 = 5V, V5 = 0V, SW9A = SW9B = ON, V17 = 5V S9 = sine wave (200mVp-p, f = 1.2kHz), referenced (0dB) to VBLPC. S29 = Comp.Sync	8	11	14	dB
PB chroma signal output level	VOP	S14	T18	SW1 = ON, V1 = 5V, V5 = V6 = 0V, V17 = 5V S14 = sine wave (50mVp-p, f = 1.1MHz) SW9B = ON, S29 = Comp.Sync	130	160	190	mVp-p

Continued on next page.

LA7358M

Continued from preceding page.

Parameter	Symbol	Input	Test point	Conditions	Ratings			Unit
					min	typ	max	
PB chroma signal output unwanted spectrum (1)	GSP1	S14	T18	SW1 = ON, V1 = 5V, V5 = 0V, V17 = 5V S14 = sine wave (50mVp-p, f = 1.1MHz) SW9B = ON, S29 = Comp.Sync Measure 2.2MHz component at T18. Referenced (0dB) to VOP.		-25	-15	dB
PB chroma signal output unwanted spectrum (2)	GSP2	S14	T18	SW1 = ON, V1 = 5V, V5 = 0V, V17 = 5V S14 = sine wave (50mVp-p, f = 1.1MHz) SW9B = ON, S29 = Comp.Sync Measure 3.3MHz component at T18. Referenced (0dB) to VOP.		-20	-10	dB
CLK input level	VCLK	S2		f = 4.433619MHz	100	200	800	mVp-p
Sync signal input threshold level	VTHS	S29			1.8	2	2.2	V
REC mode sync gate start time (MUTE OFF)	TRGB	S29	T12	SW1 = ON, V1 = 5V, V5 = 0V, V17 = 0V, S16 = sine wave (200mVp-p, 4.286MHz) SW22B = ON, S29 = Comp.Sync (Note7)	-0.3	0.2	0.7	μs
REC mode sync gate start time (MUTE ON)	TRGBM	S29	T12	SW1 = ON, V1 = 5V, V5 = 0V, V17 = 0V, S16 = sine wave (200mVp-p, 4.286MHz) SW22B = ON, S29 = Comp.Sync (Note7) SW2 = ON	1.5	2	2.5	μs
REC mode sync gate release time	TRGE	S29	T12	SW1 = ON, V1 = 5V, V5 = 0V, V17 = 0V, S16 = sine wave (200mVp-p, 4.286MHz) SW22B = ON, S29 = Comp.Sync (Note7) SW2 = ON	4.5	5.0	5.5	μs
REC mode mute setting resistance	VTSP2	S16	T18	(Note8)	10	20	30	kΩ
PB mode sync gate start time	TPGB	S29	T18	SW1 = ON, V5 = 0V, SW9B = ON, S14 = sine wave (50mVp-p, f = 1.0715MHz) V17 = 5V, S29 = Comp.Sync (Note9)	1.5	2	2.5	μs
PB mode sync gate release time	TPGE	S29	T18	SW1 = ON, V5 = 0V, SW9B = ON, S14 = sine wave (50mVp-p, f = 1.0715MHz) V17 = 5V, S29 = Comp.Sync (Note9)	4.5	5.0	5.5	μs
BGP start time	TBGB	S29	T28	V5 = 0V, V6 = 5V, SW22B = ON, V17 = 0V S29 = Comp.Sync (Note10)	6.4	6.55	6.7	μs
BGP width	TBGW	S29	T28	V5 = 0V, V6 = 5V, SW22B = ON, V17 = 0V S29 = Comp.Sync (Note10)	2.3	2.5	2.7	μs
SECAM detection output resistance	R28		T28	SW27 = ON, V27 = 5V (Note11)	7	10	13	kΩ
REC mode SECAM detection characteristics (1)	VSCMR1	S16	T28	V5 = 0V, V17 = 0V, SW22B = ON, S29 = Comp.Sync S16 = SECAM color bar signal (Note12)	4.5			V
REC mode SECAM detection characteristics (2)	VSCMR2	S16	T28	V5 = 0V, V17 = 0V, SW22B = ON, S29 = Comp.Sync S16 = PAL color bar signal (Note13)			0.5	V
PB mode phase detection output differential voltage (1)	VSCPD1	S14	T25 T26	V5 = 0V, SW9B = ON, V17 = 5V, S29 = Comp.Sync S14 = sine wave (50mVp-p, f = 1.0625/1.1016MHz) (Note14)	150	180		mV

Continued on next page.

LA7358M

Continued from preceding page.

Parameter	Symbol	Input	Test point	Conditions	Ratings			Unit
					min	typ	max	
PB mode phase detection output differential voltage (2)	VSCPD2	S14	T25 T26	V5 = 0V, SW9B = ON, V17 = 5V, S29 = Comp.Sync S14 = sine wave (50mVp-p, f = 627kHz) (Note14)			100	mV
PB mode phase detection output differential voltage (3)	VSCPD3	S14	T25 T26	V5 = 0V, SW9B = ON, V17 = 5V, S29 = Comp.Sync S14 = sine wave (50mVp-p, f = 0.7/1.04MHz) (Note14)			100	mV
PB mode SECAM detection characteristics (1)	VSCMP1	V25 V26	T28	V17 = 5V, SW25 = SW26 = ON (Note15)	4.5			V
PB mode SECAM detection characteristics (2)	VSCMP2	V25 V26	T28	V17 = 5V, SW25 = SW26 = ON (Note15)			0.5	V
PB mode SECAM detection characteristics (3)	VSCMP3	V25 V26	T28	V17 = 5V, SW25 = SW26 = ON (Note15)			0.5	V
SECAM detection comparator threshold voltage	VTCOMP	V27	T28	SW27 = ON	3.2	3.5	3.8	V
REC/PB control threshold voltage	VTRP	V17			2.3	2.5	2.7	V
Forced SECAM mode threshold voltage	VTHSM	V1	T18	V17 = 0V, SW27 = ON, V27 = 3V S29 = Comp.Sync S16 = sine wave (200mVp-p, f = 4.286MHz)			4	V
Forced MUTE mode threshold voltage	VTHMM	V1	T18	V17 = 0V, SW27 = ON, V27 = 4V S29 = Comp.Sync S16 = sine wave (200mVp-p, f = 4.286MHz)	1			V
Reference voltage	VREG	V13	T13		4.1	4.3	4.5	V

LA7358M

Package Dimensions

unit : mm

3273C

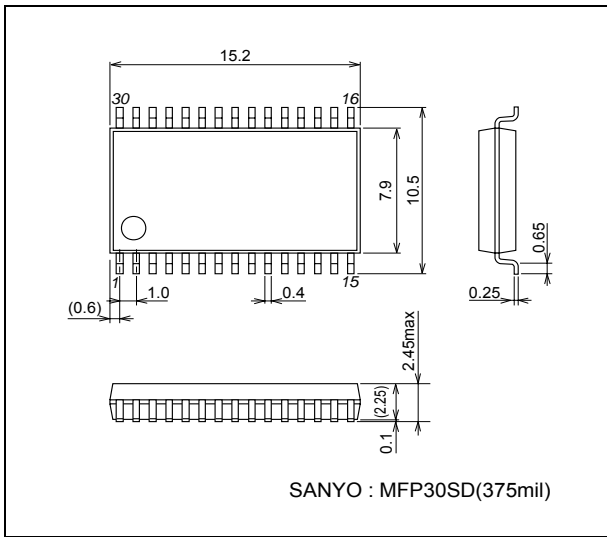

Block Diagram and Application Circuit Example

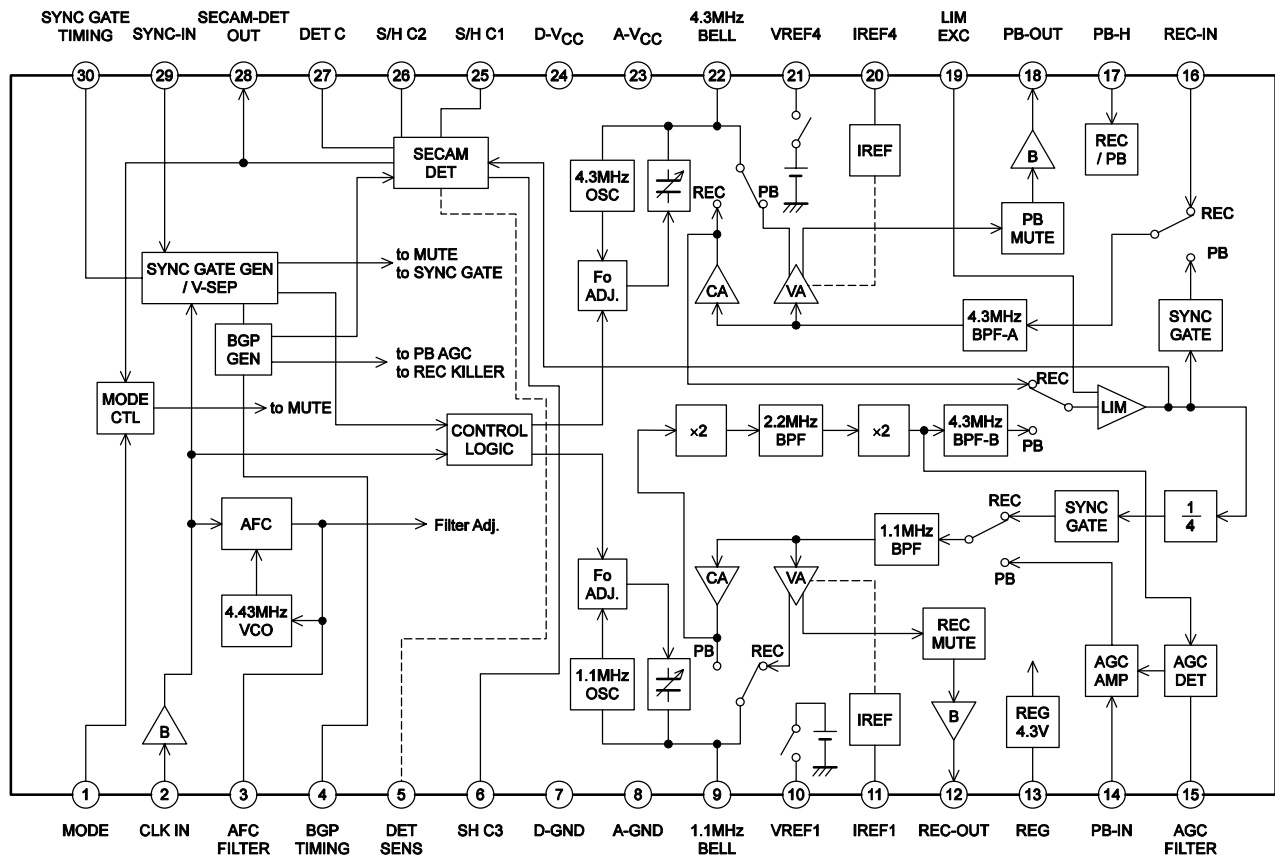

LA7358M

Pin equivalent circuit

Pin No.	Pin name	Function	DC voltage	Signal wave form	Equivalent circuit
1	MODE IN		2.5V	DC	
2	CLK IN		4.0V		
3	AFC-FILTER		3.5V	DC	
4	BGP TIMING		1 to 5V		
5	DET SENSE	An adjusting sensitivity terminal for SECAM detecting circuit.	Add DC voltage of 2V to 4V.	DC	
	VCO OUT	TEST MODE	4.9V (TEST mode: connect 1kΩ between V _{CC} .)		
	TEST CTL	A setting terminal for TEST mode.	Add DC voltage of 4.5V to V _{CC} .	DC	
6	SH3	A terminal for holding limiter voltage of phase detection output of SECAM detection.	3.1V	DC	

Continued on next page.

LA7358M

Continued from preceding page.

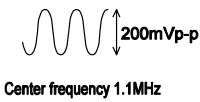
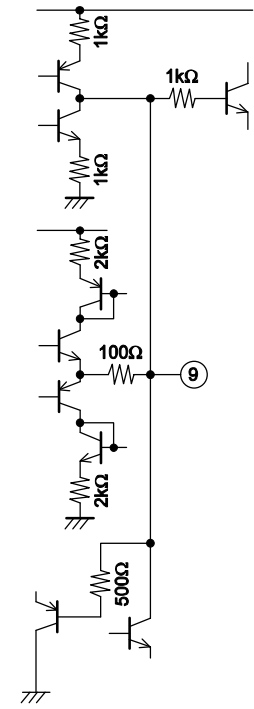
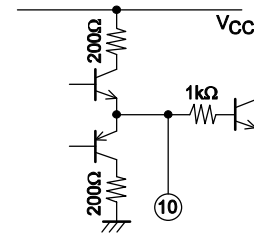
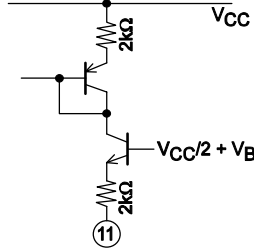
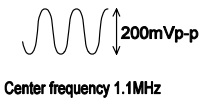
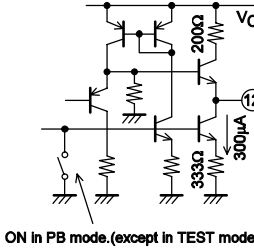
Pin No.	Pin name	Function	DC voltage	Signal wave form	Equivalent circuit
7	D-GND		0V		
8	A-GND		0V		
9	BELL1	A terminal for connecting filter of current Amp. Operate in PB mode	2.5V	 <p style="text-align: center;">Center frequency 1.1MHz</p>	
		A terminal for connecting filter of voltage Amp. Operate in REC mode	2.5V		
		Operate during automatic adjusting BELL-filter (a part of V period).	2.5V		
10	VREF1	Occur voltage in PB mode and BELL-filter automatic adjusting mode.	2.5V	DC	
11	IREF1	Setting reference current (Adjusting gain of BELL-filter output)	2.3V	DC	
12	REC-OUT		REC : 2.5V PB : OPEN	 <p style="text-align: center;">Center frequency 1.1MHz</p>	 <p style="text-align: center;">ON in PB mode.(except in TEST mode)</p>

Continued on next page.

LA7358M

Continued from preceding page.

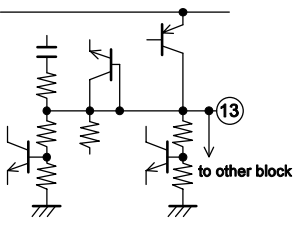
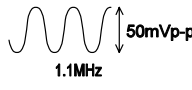
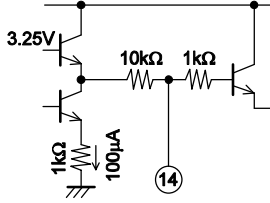
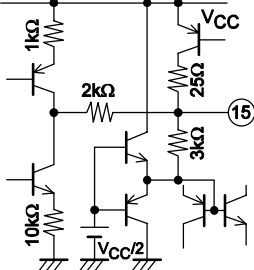
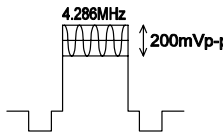
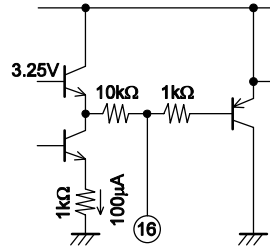
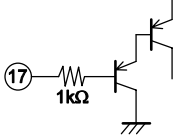
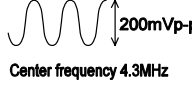
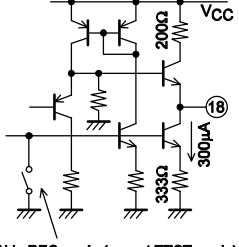
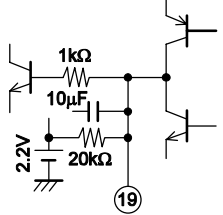
Pin No.	Pin name	Function	DC voltage	Signal wave form	Equivalent circuit
13	REG-4.2V	A terminal of reference voltage output.	4.2V	DC	
14	PB-IN		2.5V		
15	AGC-FILTER	PB MODE REC MODE KILLER-FILTER	$V_{CC}/2 \pm V_{BE}$	DC	
16	REC-IN		2.5V		
17	PB/REC mode	$V_{TH} = V_{CC}/2$ selecting control	0 to V_{CC}	DC	
18	PB-OUT		B : 2.5V REC : OPEN		 ON in REC mode.(except TEST mode)
19	LIM-EXC		2.3V	DC	

Continued on next page.

LA7358M

Continued from preceding page.

Pin No.	Pin name	Function	DC voltage	Signal wave form	Equivalent circuit
20	IREF4	Setting reference current (adjusting gain of BELL-filter output).	2.3V	DC	
21	VREF4	Occur voltage in PB mode and BELL-filter automatic adjusting mode.	2.5V	DC	
22	BELL4 (REC mode)	A terminal for connecting filter of current Amp. Operate in REC mode	2.5V		
		Operate in PB mode a terminal for connecting filter of voltage Amp.	2.5V		
		Operate during adjusting automatic BELL-filter (a part of V period).	2.5V		
23	A-VCC		5V	DC	
24	G-VCC		5V	DC	
25	SHC1	A terminal of sample & HOLD.	2.5V	DC (when connecting condensor)	

Continued on next page.

LA7358M

Continued from preceding page.

Pin No.	Pin name	Function	DC voltage	Signal wave form	Equivalent circuit
26	SHC2	A terminal of sample & HOLD.	2.5V	DC (when connecting condensor)	
27	DETC		2 to 5V	DC	
28	SECAM DET OUT (Generally)	Operate except in TEST mode.	0 to 5V		
	BGP MONITOR (TEST mode)	Operate in TEST mode.			
29	SYNC IN		Threshold voltage 2.0V		
30	RC DELAY		0 to 5V		

LA7358M

Test Circuits

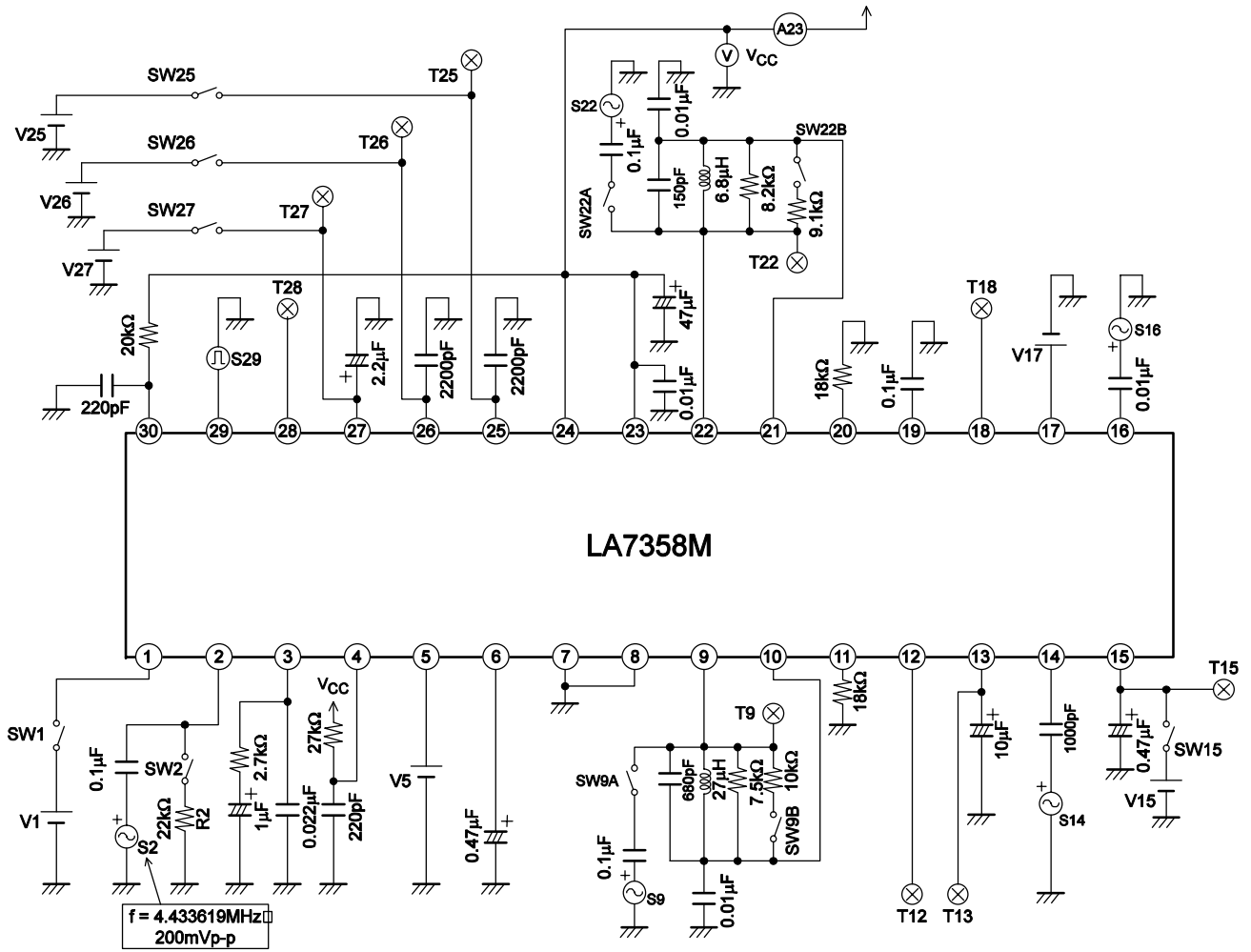

Supplemental Description

(Note 1) REC mode BELL centre frequency (1) (FBLR1) / (2) (FBLR2) :

Input a sine wave (200mVp-p, 4 to 5MHz) to S16 and measure the amplitude at pin 22 using an FET probe.
Assign to FBLR1 / FBLR2 the frequency at S16 when the amplitude is maximized.

(Note 2) REC mode killer operating level (GKLR) :

Input a color bar signal (Fig. 1) to S16 and take 0dB as the color signal level.
Gradually decrease the color signal level at S16 and assign to GKLR [dB] the level at S16 when the voltage at T28 becomes 2.5V or less, provided that the sync signal at pin 29 lags that at S16 by 1.1μs.

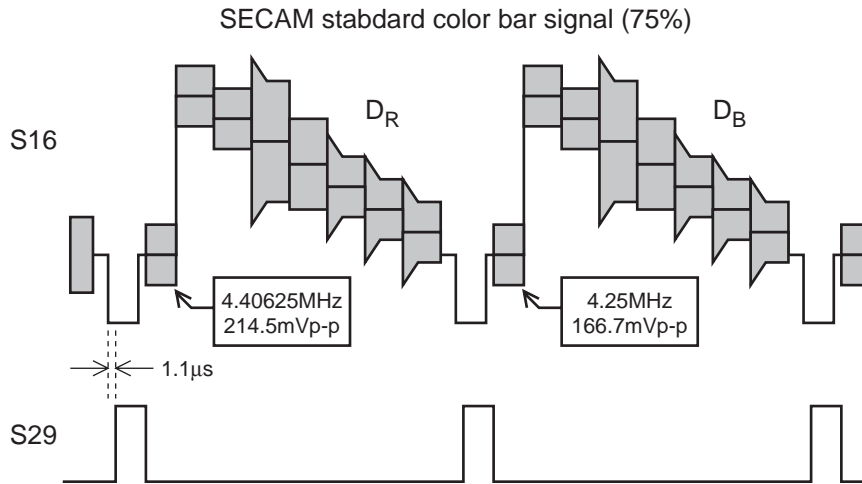

Fig.1

(Note 3) REC EQ centre frequency (1) (FEQR2) / (2) (FEQR2) :

Observe the waveform at T12 when S22 = sine wave (200mVp-p, 4 to 5MHz) is input and assign to FBLR1 / FBLR2 the frequency at T12 when the amplitude is minimized.

(Note 4) Assign to V15R the voltage at the time of VAGC measurement.

(Note 5) PB EQ centre frequency (1) (FEQP1) / (2) (FEQP2) :

Input a sine wave (50mVp-p, 1 to 1.2MHz) to S14 and assign to FEQP1 / FEQP2 the frequency at S14 when the signal level is maximized.

(Note 6) PB BELL centre frequency (1) (FBLP1) / (2) (FBLP2) :

Input a sine wave (200mVp-p, 1 to 1.2MHz) to S9 and assign to FBQP1 / FBQP2 the frequency at T18 when the signal level at T9 is minimized.

(Note 7) REC mode sync gate start time, release time (TRGB, TRGBM, TRGE) :

Input Comp. sync to S29 and take the sync gate start time (TRGB) as the time from when the signal at T12 attenuates until the signal at S29 rises and the sync gate release time (TRGE) as the time from when take TRGBM as the sync gate start time when muting in turned on with a resistor connected to GND at SW2 = ON. (See Fig. 2)

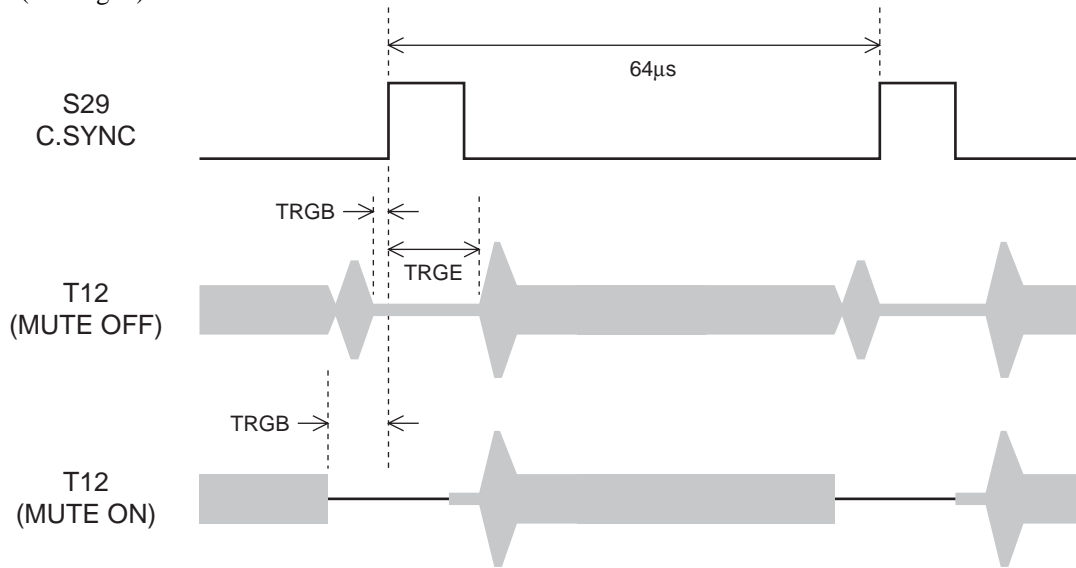

Fig.2 REC mode sync gate timing

(Note 8) REC mode mute setting resistance :

R2 value used to set T12 (MUTE-SW ON) state in REC mode in Fig.2.

(Note 9) PB mode sync gate start time, release time (TRGB, TPGE) :

Input Comp.sync to S29 and take the sync gate start time (TRGB) as the time from when the signal at T18 attenuates until the horizontal sync signal rises until the signal at T18 starts increasing.

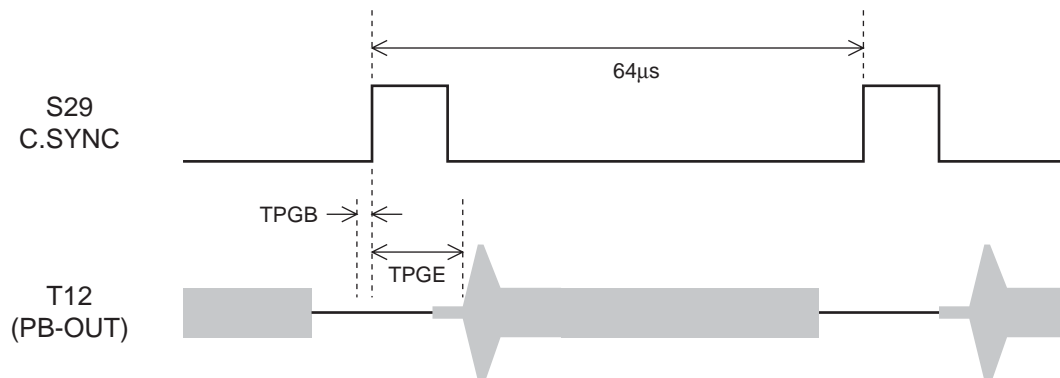

Fig.3 Sync gate timing

LA7358M

(Note 10) BGP start time, BGP width. (See Fig. 4)

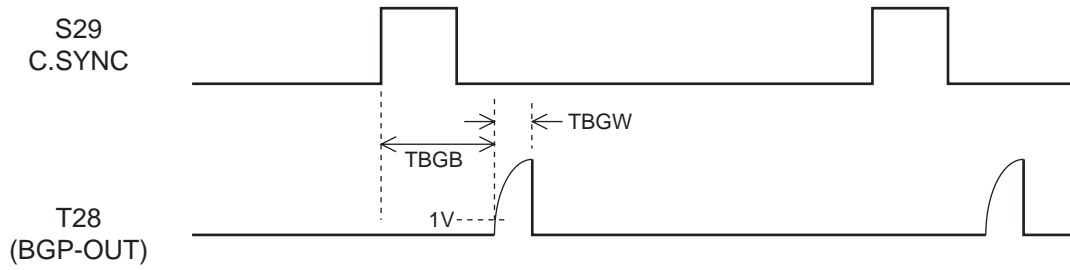

Fig.4 BGP timing

(Note 11) Assign to V28 as when generating 100μA of current from pin 28 by adding 5V to pin 27 and take "H" as detection output at pin 28 is :

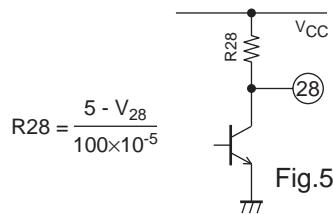

Fig.5

(Note 12) The sync signal at pin 29 must lag the SECAM color bar signal synchronization by 1.1μs. (See Fig. 1)

(Note 13) The sync signal at pin 29 must lag the PAL color bar signal synchronization by 1.1μs. (See Fig. 6)

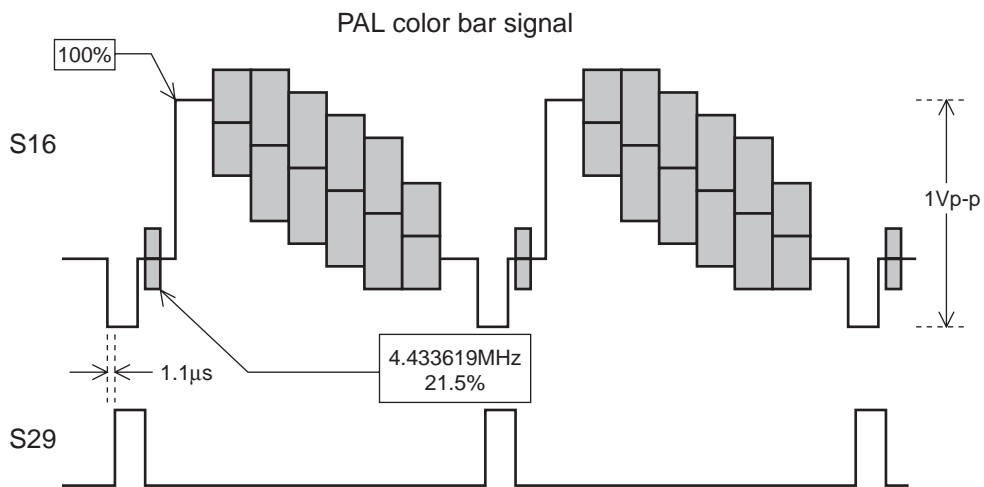

Fig.6

(Note 14) PB mode phase detection output differential voltage :

VSAPD1: Assign to VPD1 the DC voltage at pin 25 when a sine wave of 1.0625MHz is input to pin 14 and
VPD2 the DC voltage at pin 26 when a sine wave of 1.1016MHz is input.

$$VSCPD1 = VPD2 - VPD1$$

VSAPD2: Assign to VPD3 and VPD4 the voltage at pin 25 and pin 26, respectively, when a sine wave of 627kHz is input to pin 14.

$$VSCPD2 = VPD4 - VPD3$$

VSCPD3: Assign to VPD5 the DC voltage at pin 25 when a sine wave of 3.7MHz is input to pin 14 and
VPD6 the DC voltage at pin 26 when a sine wave of 1.04MHz is input.

$$VSCPD3 = VPD6 - VPD5$$

(Note 15) PB mode SECAM detection characteristics VSCMP1/VSCMP2 :

SCMP1: Apply the above-mentioned VPD1 and VPD2 to pin 25 and pin 26, respectively and then measure the voltage at T28.

VSCMP2: Apply the above-mentioned VPD3 and VPD4 to pin 25 and pin 26, respectively and then measure the voltage at T28.

- Specifications of any and all SANYO Semiconductor products described or contained herein stipulate the performance, characteristics, and functions of the described products in the independent state, and are not guarantees of the performance, characteristics, and functions of the described products as mounted in the customer's products or equipment. To verify symptoms and states that cannot be evaluated in an independent device, the customer should always evaluate and test devices mounted in the customer's products or equipment.
- SANYO Semiconductor Co., Ltd. strives to supply high-quality high-reliability products. However, any and all semiconductor products fail with some probability. It is possible that these probabilistic failures could give rise to accidents or events that could endanger human lives, that could give rise to smoke or fire, or that could cause damage to other property. When designing equipment, adopt safety measures so that these kinds of accidents or events cannot occur. Such measures include but are not limited to protective circuits and error prevention circuits for safe design, redundant design, and structural design.
- In the event that any or all SANYO Semiconductor products (including technical data, services) described or contained herein are controlled under any of applicable local export control laws and regulations, such products must not be exported without obtaining the export license from the authorities concerned in accordance with the above law.
- No part of this publication may be reproduced or transmitted in any form or by any means, electronic or mechanical, including photocopying and recording, or any information storage or retrieval system, of otherwise, without the prior written permission of SANYO Semiconductor Co., Ltd.
- Any and all information described or contained herein are subject to change without notice due to product/technology improvement, etc. When designing equipment, refer to the "Delivery Specification" for the SANYO Semiconductor product that you intend to use.
- Information (including circuit diagrams and circuit parameters) herein is for example only; it is not guaranteed for volume production. SANYO Semiconductor believes information herein is accurate and reliable, but no guarantees are made or implied regarding its use or any infringements of intellectual property rights or other rights of third parties.

This catalog provides information as of November, 2006. Specifications and information herein are subject to change without notice.