



**DUAL FORWARD-CONDUCTING P-GATE THYRISTOR  
PROGRAMMABLE OVERVOLTAGE PROTECTOR**

**TISP61089HDM Overvoltage Protector**

Intended for Use in GR-1089-CORE Issue 3 Compliant Line Cards

Dual, Voltage-Programmable SLIC Protector  
 - Low 15 mA max. Gate Triggering Current  
 - Supports Battery Voltages Down to -155 V  
 - High 150 mA min. Holding Current

Rated for GR-1089-CORE Issue 3 Conditions

| Impulse Waveshape | GR-1089-CORE Test |        | I <sub>PPSM</sub><br>A |
|-------------------|-------------------|--------|------------------------|
|                   | Section           | Test # |                        |
| 2/10              | 4.6.7             | 4      | 500                    |
|                   | 4.6.8             | 1      |                        |
| 10/1000           | 4.6.7             | 1, 3   | 100                    |
|                   | 4.6.7.1           | 1      |                        |

Meets GR-1089-CORE First Level A.C. Power Fault Conditions

| GR-1089-CORE<br>Section 4.6.10<br>Test # | I <sub>RMS</sub> | Power Fault Duration |
|--|------------------|----------------------|
|  | A                | s                    |
| 1  | 0.33             | 900                  |
| 2  | 0.17             | 900                  |
| 3  | 1                | 1                    |
| 4  | 1                | 1                    |
| 6  | 0.5              | 30                   |
| 7  | 2.2              | 2                    |
| 8  | 3                | 1.1                  |
| 9  | 5                | 0.4                  |

GR-1089-CORE Second Level A.C. Power Fault Conditions are Detailed in the 'Applications Information' Section

..... UL Recognized Component

**How To Order**

| Device       | Package          | Carrier              | For Lead Free Termination Finish Order As | Marking Code | Standard Quantity |
|--------------|------------------|----------------------|---|--------------|-------------------|
| TISP61089HDM | 8-SOIC (210 mil) | Embossed Tape Reeled | TISP61089HDMR-S                           | 61089H       | 2000              |

**Description**

The TISP61089HDM is a dual forward-conducting buffered p-gate thyristor (SCR) overvoltage protector. It is designed to protect monolithic SLICs (Subscriber Line Interface Circuits) against overvoltages on the telephone line caused by lightning, a.c. power contact and induction. The TISP61089HDM limits voltages that exceed the SLIC supply rail voltage. The TISP61089HDM parameters are specified to allow equipment compliance with Telcordia GR-1089-CORE, Issue 3 and ITU-T recommendations K.20, K.21 and K.45.

The SLIC line driver section is typically powered from 0 V (ground) and a negative voltage in the region of -20 V to -155 V. The protector gate is connected to this negative supply. This references the protection (clipping) voltage to the negative supply voltage. The protection voltage will then track the negative supply voltage and the overvoltage stress on the SLIC is minimized.

\*RoHS Directive 2002/95/EC Jan 27 2003 including Annex  
 MAY 2004 - REVISED FEBRUARY 2005  
 Specifications are subject to change without notice.  
 Customers should verify actual device performance in their specific applications.

**8-SOIC (210 mil) Package (Top View)**

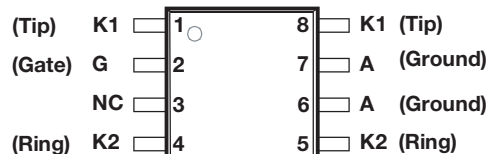

NC - No internal connection  
 Terminal typical application names shown in parenthesis

MD-8SOIC(210)-001-b

**Device Symbol**

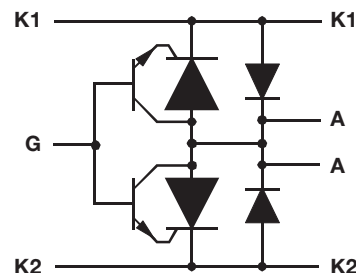

The negative protection voltage is controlled by the voltage, V<sub>GG</sub>, applied to the G terminal.

SD-TISP6-001-a

# TISP61089HDM Overvoltage Protector

**BOURNS®**

## Description (Continued)

Positive overvoltages are clipped to ground by diode forward conduction. Negative overvoltages are initially clipped close to the SLIC negative supply rail value. If sufficient current is available from the overvoltage, then the protector SCR will switch into a low voltage on-state condition. As the overvoltage subsides the high holding current of TISP61089HDM SCR prevents d.c. latchup.

The TISP61089HDM is designed to be used with a pair of Bourns® B1250T fuses for overcurrent protection. Level 2 power fault compliance requires the series overcurrent element to become open-circuit or high impedance. For equipment compliant to ITU-T recommendations K.20, K.21 or K.45 only, the series resistor value is set by the coordination requirements. For coordination with a 400 V limit GDT, a minimum series resistor value of 6.5 Ω is recommended.

## Absolute Maximum Ratings, $T_A = 25\text{ °C}$ (Unless Otherwise Noted)

| Rating  | Symbol     | Value                                  | Unit |
|---|------------|--|------|
| Repetitive peak off-state voltage, $V_{GK} = 0$   | $V_{DRM}$  | -170                                   | V    |
| Repetitive peak gate-cathode voltage, $V_{KA} = 0$  | $V_{GKRM}$ | -167                                   | V    |
| Non-repetitive peak impulse current (see Notes 1, 2 and 3)<br>10/1000 μs (Telcordia GR-1089-CORE, Issue 3)<br>5/310 μs (ITU-T K.20, K.21 & K.45, K.44 open-circuit voltage wave shape 10/700 μs)<br>10/360 μs (Telcordia GR-1089-CORE, Issue 3)<br>1.2/50 μs voltage waveshape (Telcordia GR-1089-CORE, Issue 3), including 3 Ω non-inductive resistor<br>2/10 μs (Telcordia GR-1089-CORE, Issue 3) | $I_{PPSM}$ | 100<br>150<br>100<br>500<br>500        | A    |
| Non-repetitive peak on-state current, 50 Hz / 60 Hz (see Notes 1, 2, 3 and 4)<br>0.5 s<br>1 s<br>2 s<br>5 s<br>30 s<br>900 s  | $I_{TSM}$  | 7.7<br>6.1<br>4.8<br>3.7<br>2.8<br>2.6 | A    |
| Junction temperature  | $T_J$      | -40 to +150                            | °C   |
| Storage temperature range   | $T_{stg}$  | -65 to +150                            | °C   |

- NOTES: 1. Initially the device must be in thermal equilibrium with  $T_J = 25\text{ °C}$ . The surge may be repeated after the device returns to its initial conditions.
2. The rated current values may be applied either to the Ring to Ground or to the Tip to Ground terminal pairs. Additionally, both terminal pairs may have their rated current values applied simultaneously (in this case the Ground terminal current will be twice the rated current value of an individual terminal pair). Ratings are obtained by using the gate circuitry as shown in Fig. 3.
3. Rated currents only apply if pins 1 & 8 (Tip) are connected together, pins 4 & 5 (Ring) are connected together and pins 6 & 7 (Anode) are connected together.
4. EIA/JESD51-2 environment and EIA/JESD51-7 high effective thermal conductivity test board (multi-layer) connected with 0.6 mm printed wiring track widths.

## Electrical Characteristics, $T_A = 25\text{ °C}$ (Unless Otherwise Noted)

| Parameter   | Test Conditions  | Min | Typ | Max            | Unit |
|---|--|-----|-----|----------------|------|
| $I_D$ Off-state current                             | $V_D = V_{DRM}$ , $V_{GK} = 0$<br>$T_A = 25\text{ °C}$<br>$T_A = 85\text{ °C}$   |     |     | -5<br>-50      | μA   |
| $V_{GK(BO)}$ Gate-cathode impulse breakover voltage | 10/1000 μs, $I_{TM} = 100\text{ A}$ , $V_{GG} = -100\text{ V}$<br>5/310 μs, $I_{TM} = 150\text{ A}$ , $V_{GG} = -100\text{ V}$<br>2/10 μs, $I_{TM} = 200\text{ A}$ , $V_{GG} = -100\text{ V}$ (see Note 5) |     |     | 12<br>12<br>20 | V    |
| $V_F$ Forward voltage                               | $I_F = 5\text{ A}$ , $t_W = 200\text{ μs}$   |     |     | 3              | V    |
| $V_{FRM}$ Peak forward recovery voltage             | 10/1000 μs, $I_F = 100\text{ A}$ , $V_{GG} = -100\text{ V}$<br>5/310 μs, $I_F = 150\text{ A}$ , $V_{GG} = -100\text{ V}$<br>2/10 μs, $I_F = 200\text{ A}$ , $V_{GG} = -100\text{ V}$ (see Note 5)          |     |     | 6<br>7<br>10   | V    |

# TISP61089HDM Overvoltage Protector

**BOURNS®**

## Electrical Characteristics, $T_A = 25\text{ }^\circ\text{C}$ (Unless Otherwise Noted) (Continued)

| Parameter                                    | Test Conditions  | Min  | Typ | Max       | Unit          |
|--|--|------|-----|-----------|---------------|
| $I_H$ Holding current                        | $I_T = -1\text{ A}$ , $di/dt = 1\text{ A/ms}$ , $V_{GG} = -100\text{ V}$               | -150 |     |           | mA            |
| $I_{GKS}$ Gate reverse current               | $V_{GG} = V_{GK} = V_{GKRM}$ , $V_{KA} = 0$  |      |     | -5<br>-50 | $\mu\text{A}$ |
| $I_{GT}$ Gate trigger current                | $I_T = -3\text{ A}$ , $t_{p(g)} \geq 20\text{ }\mu\text{s}$ , $V_{GG} = -100\text{ V}$ |      |     | 15        | mA            |
| $V_{GT}$ Gate-cathode trigger voltage        | $I_T = -3\text{ A}$ , $t_{p(g)} \geq 20\text{ }\mu\text{s}$ , $V_{GG} = -100\text{ V}$ |      |     | 2.5       | V             |
| $C_{KA}$ Cathode-anode off-state capacitance | $f = 1\text{ MHz}$ , $V_d = 1\text{ V rms}$ , $V_D = -50\text{ V}$ , $I_G = 0$         |      |     | 40        | pF            |

NOTE: 5. Voltage measurements should be made with an oscilloscope with limited bandwidth (20 MHz) to avoid high frequency noise.

## Thermal Characteristics, $T_A = 25\text{ }^\circ\text{C}$ (Unless Otherwise Noted)

| Parameter  | Test Conditions  | Min | Typ | Max | Unit               |
|--|--|-----|-----|-----|--------------------|
| $R_{\theta JA}$ Junction to ambient thermal resistance | EIA/JESD51-7 PCB, EIA/JESD51-2 Environment, $P_{TOT} = 4\text{ W}$<br>(See Note 6) |     | 55  |     | $^\circ\text{C/W}$ |

NOTE 6. EIA/JESD51-7 high effective thermal conductivity test board (multi-layer) connected with 0.6 mm printed wiring track widths.

## Parameter Measurement Information

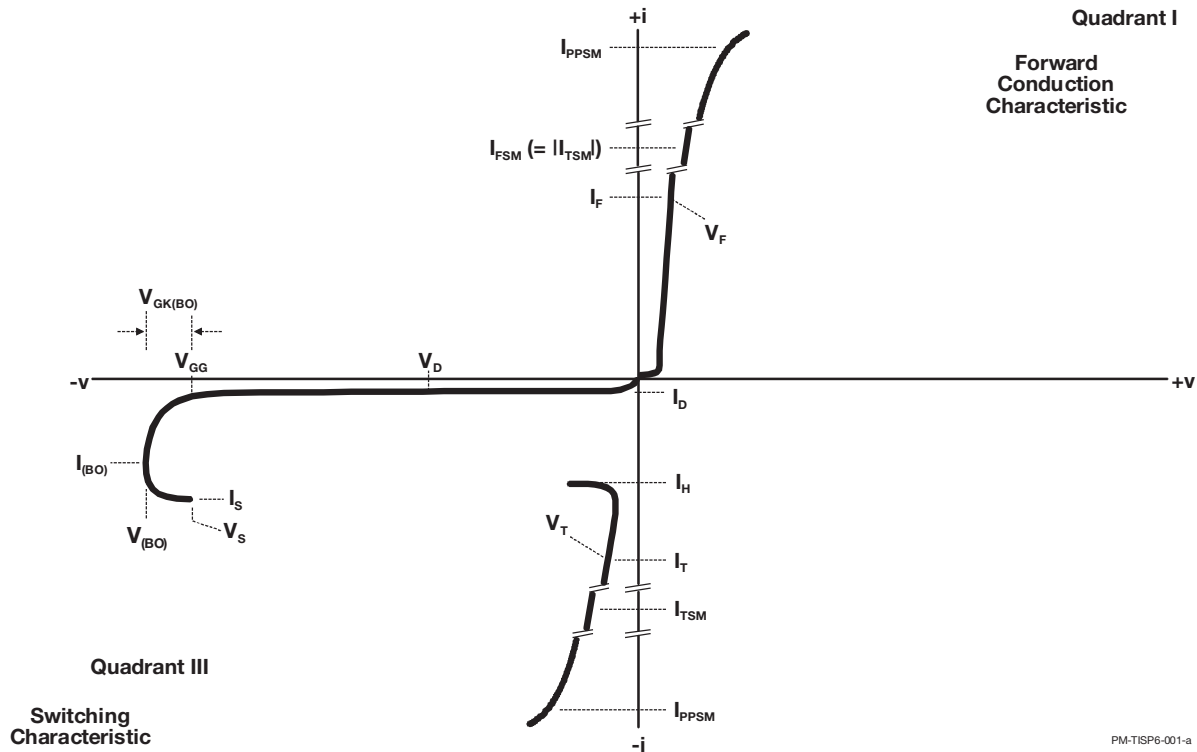

**Figure 1. Voltage-Current Characteristic**  
Unless Otherwise Noted, All Voltages are Referenced to the Anode

PM-TISP6-001-a

## Thermal Information

### NON-REPETITIVE PEAK ON-STATE CURRENT VS CURRENT DURATION

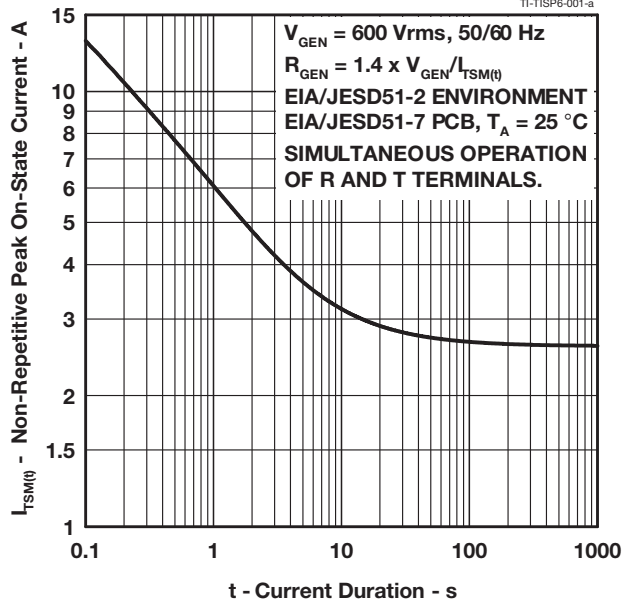
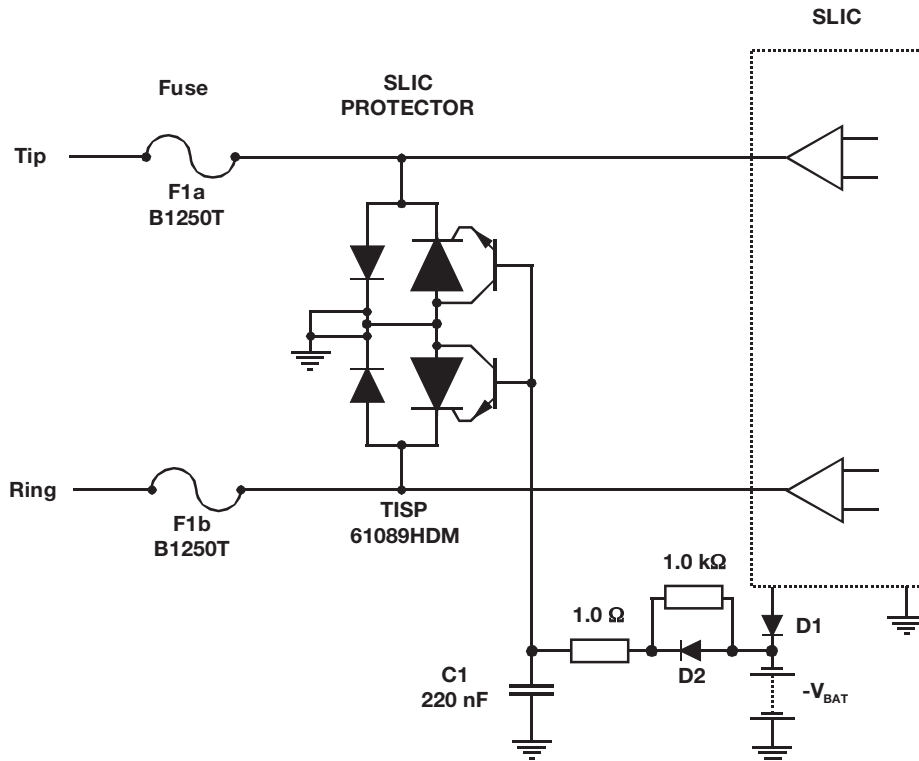

Figure 2.

## APPLICATIONS INFORMATION



AI-TISP6-001-a

**Figure 3. Line Protection with TISP61089HDM**

Figure 3 illustrates how a typical SLIC protection circuit may look for a TISP61089HDM and a pair of Bourns® Telefuse™ overcurrent protectors. This is a generic circuit that is designed to withstand both lightning surge testing and AC power fault testing. As applications can differ, it is recommended you contact your Bourns representative for detailed applications guidance on your specific design.

## APPLICATIONS INFORMATION (Continued)

**PEAK AC  
vs  
CURRENT DURATION**

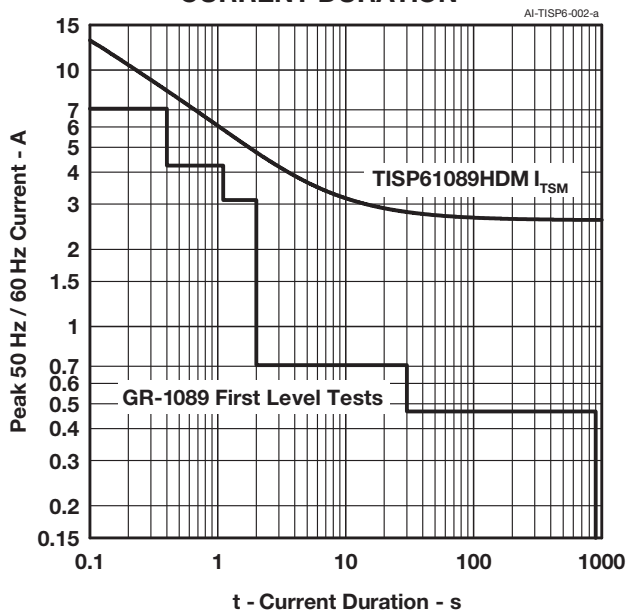

Figure 4.

**TYPICAL TIME TO OPEN  
vs  
CURRENT**

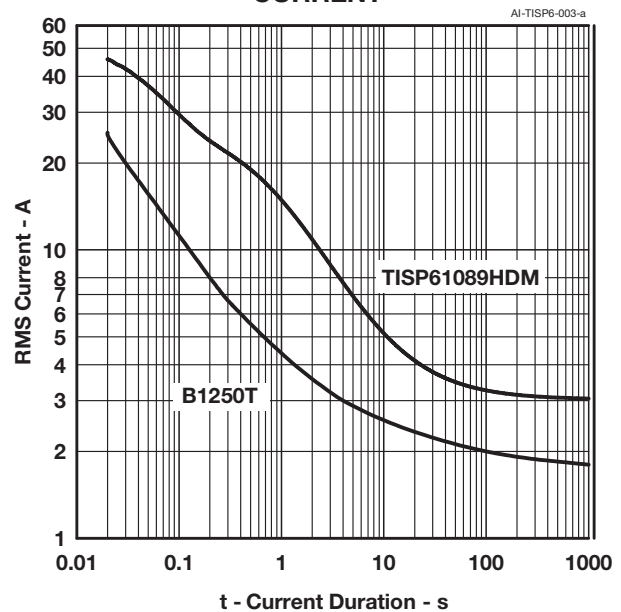

Figure 5.

GR-1089-CORE Issue A.C. Power Fault testing has been comprehended in the design of the TISP61089HDM. For compliance, circuit designs must pass both First Level and Second Level A.C. Power Fault testing.

First Level Power Fault testing requires that the equipment shall not be damaged and continues to operate correctly without disruption to other parts of the system. In laboratory tests it has been shown that the circuit shown in Figure 3 can pass these tests without damage. Figure 4 shows the TISP61089HDM  $I_{TSM}$  rating to be above the level of GR-1089-CORE First Level tests.

Second Level Power Fault testing may result in the equipment becoming non-operational, but any component failure should not allow the equipment to become a hazard. The system should not burn, fragment, or become an electrical safety hazard. The test data in Figure 5 illustrates that the TISP61089HDM and the B1250T are current coordinated, as the fuse interrupt time is shorter than the time it takes to damage the TISP61089HDM package for a given current.

### **Bourns Sales Offices**

| Region        | Phone           | Fax             |
|---------------|-----------------|-----------------|
| The Americas: | +1-951-781-5500 | +1-951-781-5700 |
| Europe:       | +41-41-7685555  | +41-41-7685510  |
| Asia-Pacific: | +886-2-25624117 | +886-2-25624116 |

### **Technical Assistance**

| Region        | Phone           | Fax             |
|---------------|-----------------|-----------------|
| The Americas: | +1-951-781-5500 | +1-951-781-5700 |
| Europe:       | +41-41-7685555  | +41-41-7685510  |
| Asia-Pacific: | +886-2-25624117 | +886-2-25624116 |

**[www.bourns.com](http://www.bourns.com)**

Bourns® products are available through an extensive network of manufacturer's representatives, agents and distributors. To obtain technical applications assistance, a quotation, or to place an order, contact a Bourns representative in your area.



"TISP" is a trademark of Bourns, Ltd., a Bourns Company, and is Registered in U.S. Patent and Trademark Office.  
"Bourns" is a registered trademark of Bourns, Inc. in the U.S. and other countries.