

SANYO

No.3511A

2SA1785/2SC46452SA1785:PNP Epitaxial Planar Silicon Transistor
2SC4645:NPN Triple Diffused Planar Silicon Transistor

High Voltage Driver Applications

Features

- Large current capacity ($I_C = 1A$)
- High breakdown voltage ($V_{CEO} \geq 400V$)

(): 2SA1785

Absolute Maximum Ratings at $T_a = 25^\circ C$

			unit
Collector to Base Voltage	V_{CBO}	(-)400	V
Collector to Emitter Voltage	V_{CEO}	(-)400	V
Emitter to Base Voltage	V_{EBO}	(-)5	V
Collector Current	I_C	(-)1	A
Collector Current(Pulse)	I_{CP}	(-)2	A
Collector Dissipation	P_C	1	W
Junction Temperature	T_j	150	$^\circ C$
Storage Temperature	T_{stg}	-55 to +150	$^\circ C$

Electrical Characteristics at $T_a = 25^\circ C$

			min	typ	max	unit
Collector Cutoff Current	I_{CBO}	$V_{CB} = (-)300V, I_E = 0$			(-)1.0	μA
Emitter Cutoff Current	I_{EBO}	$V_{EB} = (-)4V, I_C = 0$			(-)1.0	μA
DC Current Gain	h_{FE}	$V_{CE} = (-)10V, I_C = (-)100mA$	40*		200*	
Gain-Bandwidth Product	f_T	$V_{CE} = (-)10V, I_C = (-)50mA$		(50)70		MHz
C-E Saturation Voltage	$V_{CE(sat)}$	$I_C = (-)200mA, I_B = (-)20mA$			(-)1.0	V
B-E Saturation Voltage	$V_{BE(sat)}$	$I_C = (-)200mA, I_B = (-)20mA$			(-)1.0	V
C-B Breakdown Voltage	$V_{(BR)CBO}$	$I_C = (-)10\mu A, I_E = 0$	(-)400			V
C-E Breakdown Voltage	$V_{(BR)CEO}$	$I_C = (-)1mA, R_{BE} = \infty$	(-)400			V
E-B Breakdown Voltage	$V_{(BR)EBO}$	$I_E = (-)10\mu A, I_C = 0$	(-)5			V
Output Capacitance	C_{ob}	$V_{CB} = (-)30V, f = 1MHz$		(12)8		pF
Turn-ON Time	t_{on}	See specified Test Circuit.	(0.25)0.11			μs
Storage Time	t_{stg}	"	(3.0)4.0			μs
Fall Time	t_f	"	(0.3)0.65			μs

*: The 2SA1785/2SC4645 are classified by 100mA h_{FE} as follows:

40 C 80	60 D 120	100 E 200
---------	----------	-----------

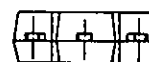
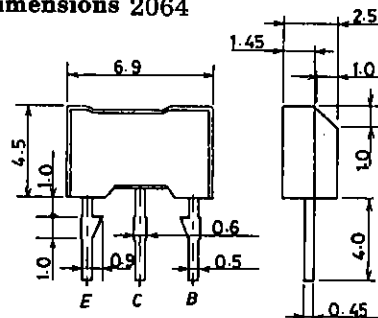
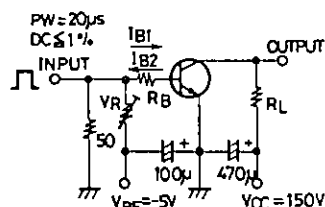
Package Dimensions 2064
(unit: mm)E: Emitter
C: Collector
B: Base
SANYO: NMP**Switching Time Test Circuit**

$10I_{B1} = -10I_{B2} = I_C = 200mA$
 $R_L = 750\Omega, R_B = 50\Omega$, at $I_C = 200mA$
 (For PNP, the polarity is reversed.)

Unit(Resistance: Ω , Capacitance: F)

SANYO Electric Co., Ltd. Semiconductor Business Headquarters
 TOKYO OFFICE Tokyo Bldg., 1-10, 1 Chome, Ueno, Taito-ku, TOKYO, 110 JAPAN

12894TH AX-8287/5170TA(KOTO) 8-6910 No.3511-1/4

2SA1785/2SC4645

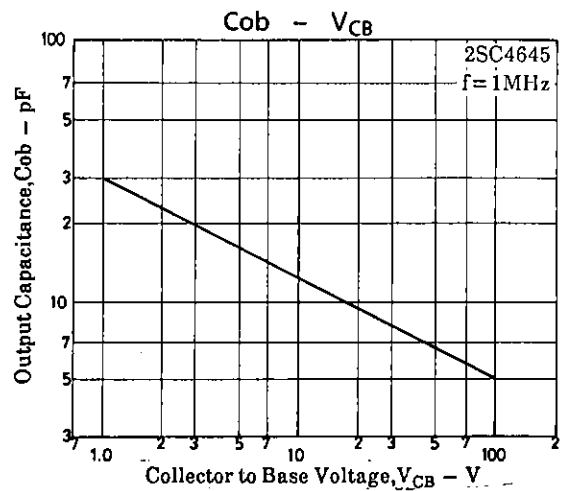
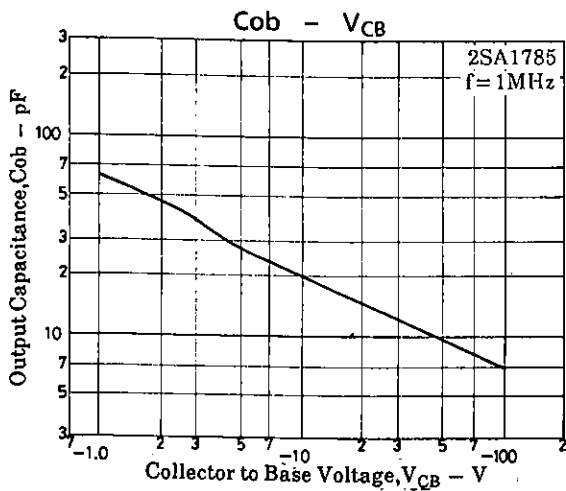
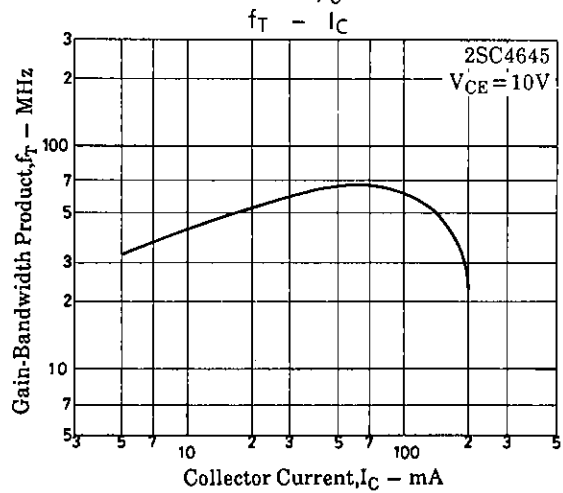
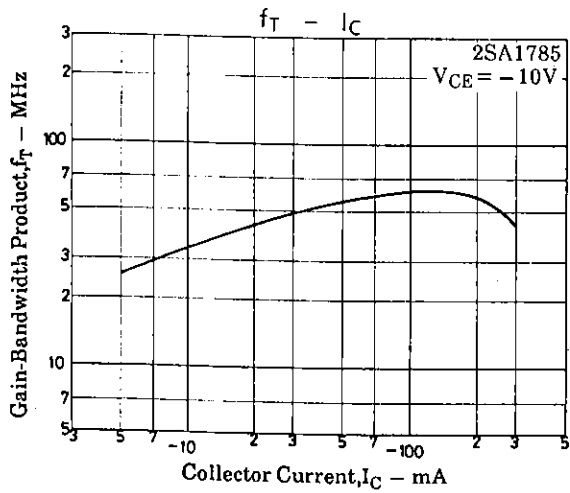
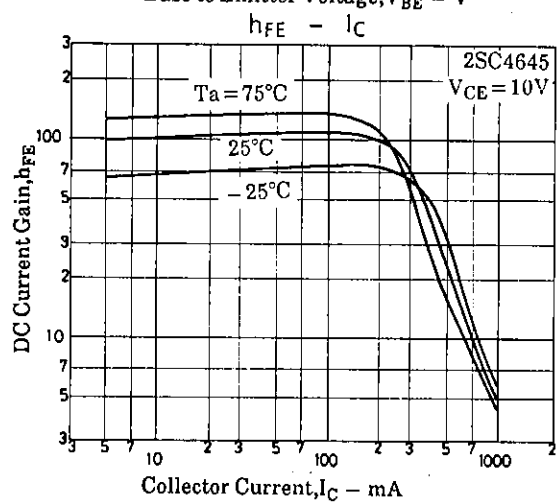
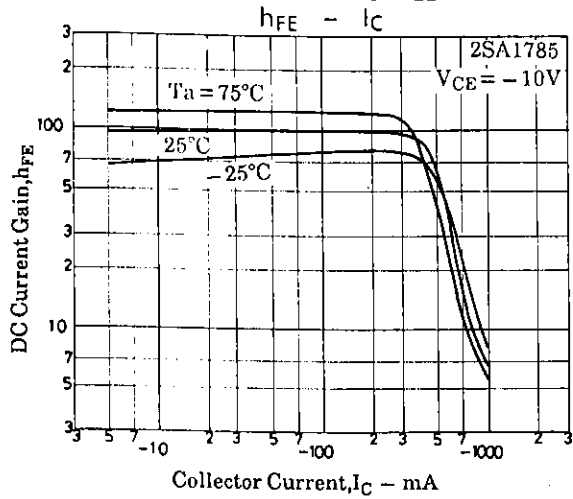
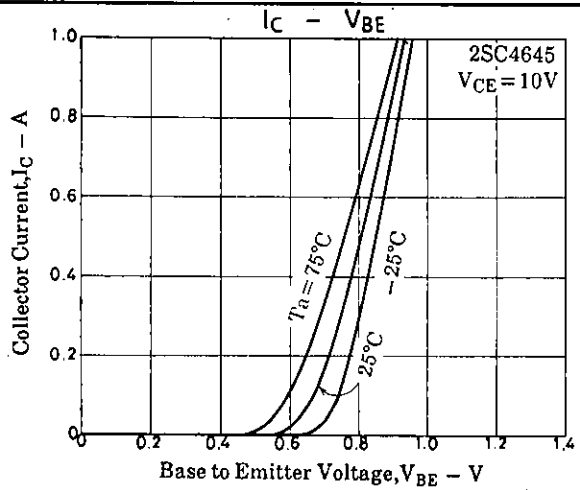
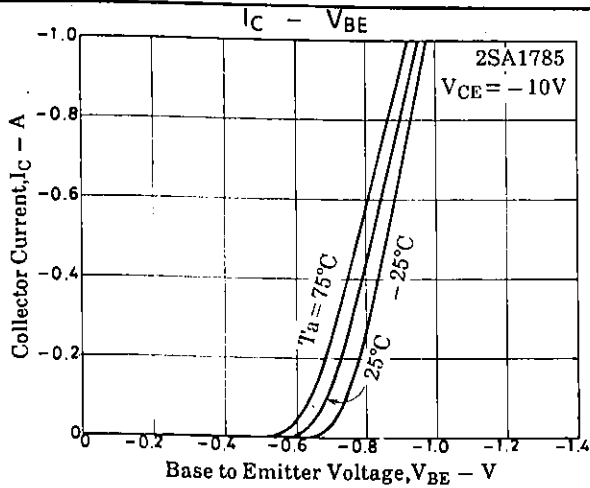

2SA1785/2SC4645

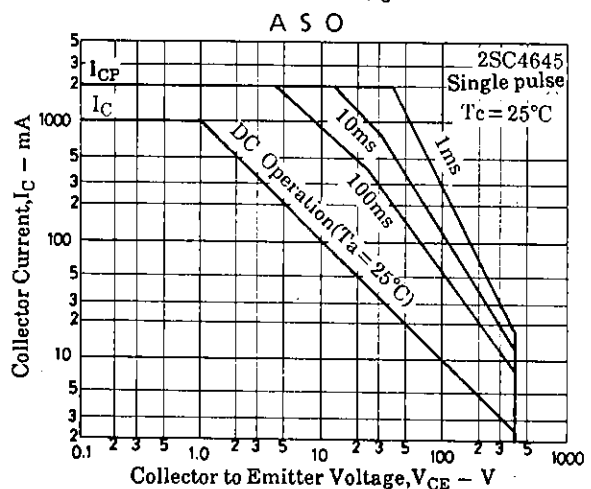
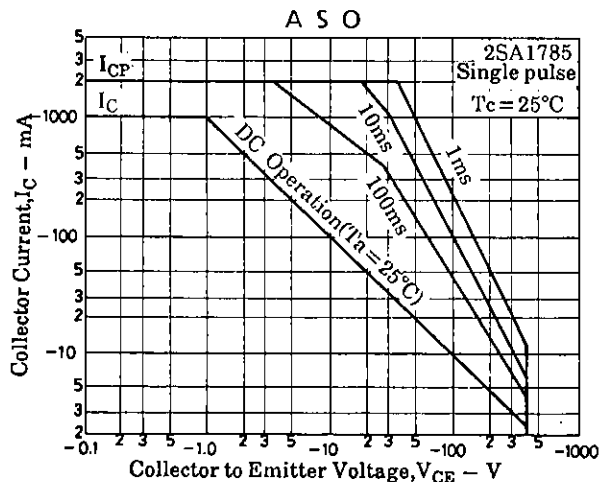
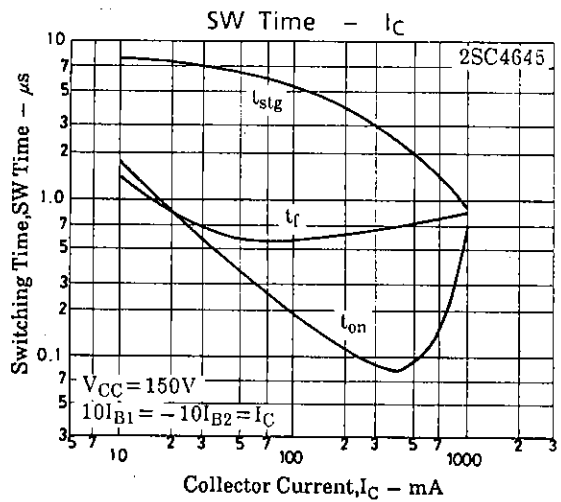
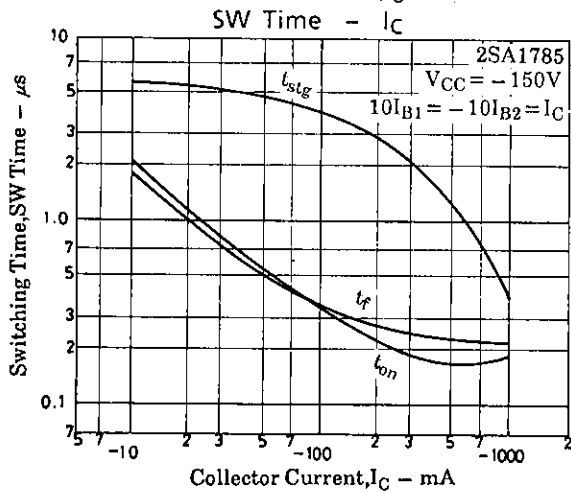
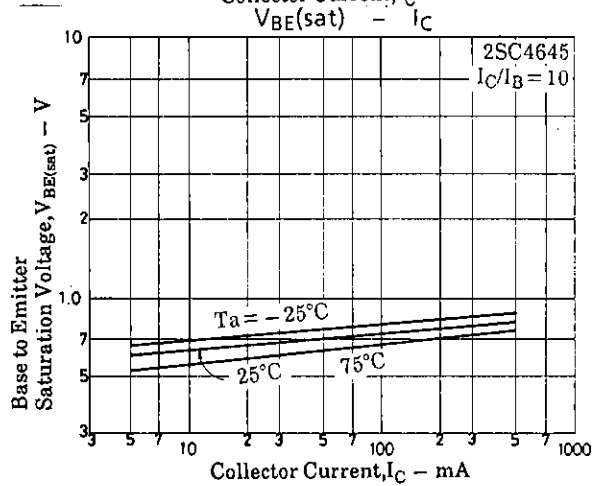
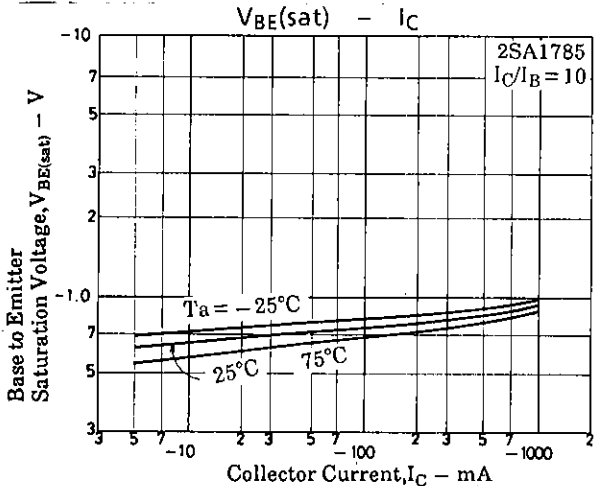
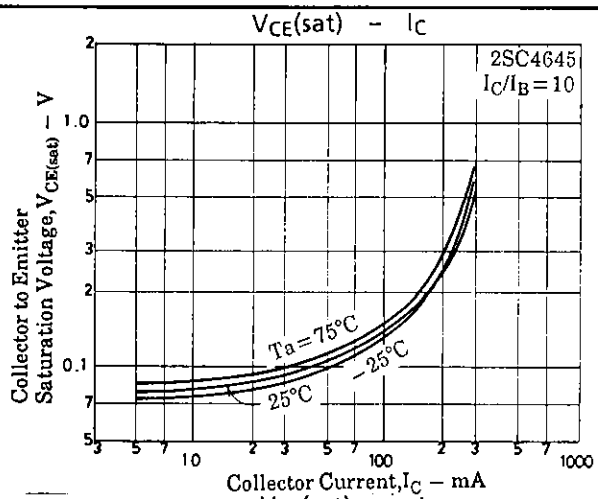
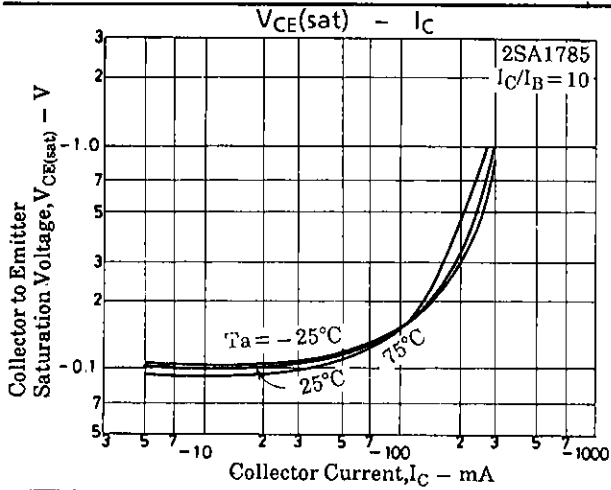

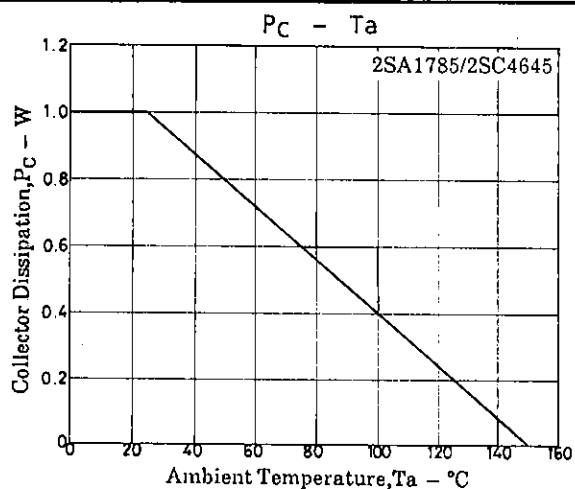

- No products described or contained herein are intended for use in surgical implants, life-support systems, aerospace equipment, nuclear power control systems, vehicles, disaster/crime-prevention equipment and the like, the failure of which may directly or indirectly cause injury, death or property loss.
- Anyone purchasing any products described or contained herein for an above-mentioned use shall:
 - ① Accept full responsibility and indemnify and defend SANYO ELECTRIC CO., LTD., its affiliates, subsidiaries and distributors and all their officers and employees, jointly and severally, against any and all claims and litigation and all damages, cost and expenses associated with such use;
 - ② Not impose any responsibility for any fault or negligence which may be cited in any such claim or litigation on SANYO ELECTRIC CO., LTD., its affiliates, subsidiaries and distributors or any of their officers and employees jointly or severally.
- Information (including circuit diagrams and circuit parameters) herein is for example only; it is not guaranteed for volume production. SANYO believes information herein is accurate and reliable, but no guarantees are made or implied regarding its use or any infringements of intellectual property rights or other rights of third parties.