

**OBSOLETE PRODUCT  
NO RECOMMENDED REPLACEMENT**  
contact our Technical Support Center at  
1-888-INTERSIL or www.intersil.com/tsc

**Video Distribution Amplifier**



The EL2099 is a high speed, monolithic operational amplifier\* featuring excellent video performance

and high output current capability. Built using Elantec's Complementary Bipolar process, the EL2099 uses current mode feedback to achieve wide bandwidth, and is stable in unity gain configuration.

Operation from power supplies ranging from  $\pm 5V$  to  $\pm 15V$  makes the EL2099 extremely versatile. With supplies at  $\pm 15V$ , the EL2099 can deliver  $\pm 11V$  into  $25\Omega$  at slew rates of  $1000V/\mu s$ . At  $\pm 5V$  supplies, output voltage range is  $\pm 3V$  into  $25\Omega$ . Its speed and output current capability make this device ideal for video line driver and automatic test equipment applications.

Differential Gain and Phase of the EL2099 are 0.03% and  $0.05^\circ$  respectively, and -3dB bandwidth is 50MHz. These features make the EL2099 especially well suited for video distribution applications.

**Pinout**

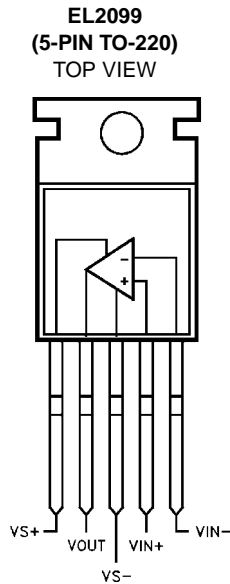

Manufactured under U.S. Patent Nos. 5,179,355, 4,893,091, U.K. Patent No. 2261786.

**Features**

- 50MHz -3dB bandwidth,  $A_V = +2$
- Differential gain 0.03%
- Differential phase  $0.05^\circ$
- Output short circuit current 800mA
- Can drive six  $75\Omega$  double terminated cables  $\pm 11V$
- Slew rate =  $1000V/\mu s$
- Wide supply voltage range  $\pm 5V$  to  $\pm 15V$

**Applications**

- Video line driver
- ATE pin driver
- High speed data acquisition

**Ordering Information**

PART NUMBER	TEMP. RANGE	PACKAGE	PKG. NO.
EL2099CT	$0^\circ C$ to $+75^\circ C$	5-Pin TO-220	MDP0028

**Absolute Maximum Ratings** ( $T_A = 25^\circ\text{C}$ )

Voltage between  $V_{S+}$  and  $V_{S-}$  .....+33V  
 Voltage at  $V_{S+}$  ..... +16.5V  
 Voltage at  $V_{S-}$  ..... -16.5V  
 Voltage between  $V_{IN+}$  and  $V_{IN-}$  .....±6V

Current into  $V_{IN+}$  or  $V_{IN-}$  ..... ±10mA  
 Internal Power Dissipation ..... See Curves  
 Operating Ambient Temperature .....  $0^\circ\text{C}$  to  $+75^\circ\text{C}$   
 Operating Junction Temperature .....  $150^\circ\text{C}$   
 Storage Temperature Range .....  $-65^\circ\text{C}$  to  $+150^\circ\text{C}$

*CAUTION: Stresses above those listed in "Absolute Maximum Ratings" may cause permanent damage to the device. This is a stress only rating and operation of the device at these or any other conditions above those indicated in the operational sections of this specification is not implied.*

*IMPORTANT NOTE: All parameters having Min/Max specifications are guaranteed. Typical values are for information purposes only. Unless otherwise noted, all tests are at the specified temperature and are pulsed tests, therefore:  $T_J = T_C = T_A$*

**Open-Loop DC Electrical Specifications**

$V_S = \pm 15\text{V}$ ,  $R_L = 25\Omega$ ,  $T_A = 25^\circ\text{C}$  unless otherwise specified

PARAMETER	DESCRIPTION	TEMP	MIN	TYP	MAX	UNITS
V <sub>OS</sub>	Input Offset Voltage	25°C		5	20	mV
		T <sub>MIN</sub> , T <sub>MAX</sub>			25	mV
TC V <sub>OS</sub>	Average Offset Voltage Drift	Full		20		µV/°C
+I <sub>IN</sub>	+Input Current	25°C		5	20	µA
		T <sub>MIN</sub> , T <sub>MAX</sub>			30	µA
-I <sub>IN</sub>	-Input Current	25°C		8	35	µA
		T <sub>MIN</sub> , T <sub>MAX</sub>			50	µA
CMRR	Common Mode Rejection Ratio (Note 1)	25°C	50	60		dB
PSRR	Power Supply Rejection Ratio (Note 2)	25°C	60	70		dB
R <sub>OL</sub>	Transimpedance	25°C	85	140		kΩ
+R <sub>IN</sub>	+Input Resistance (Note 3)	25°C	700	1000		kΩ
		T <sub>MIN</sub> , T <sub>MAX</sub>	600			kΩ
+C <sub>IN</sub>	+Input Capacitance	25°C		3		pF
CMIR	Common Mode Input Range	25°C		±12.5		V
V <sub>O</sub>	Output Voltage Swing $V_S = \pm 15\text{V}$	25°C	±9	±11		V
	Output Voltage Swing $V_S = \pm 5\text{V}$	25°C	±2.4	±3.0		V
I <sub>OUT</sub>	Output Current	25°C	360	440		mA
I <sub>SC</sub>	Output Short-Circuit Current	25°C	600	800		mA
		T <sub>MIN</sub> , T <sub>MAX</sub>		800		mA
I <sub>S</sub>	Supply Current	25°C		32	45	mA

NOTES:

1. The input is moved from -10V to +10V.
2. The supplies are moved from ±5V to ±15V.
3.  $V_{IN} = \pm 5\text{V}$ . See typical performance curve for larger values of  $V_{IN}$ .

**Closed-Loop AC Electrical Specifications**

$V_S = \pm 15V$ ,  $A_V = +2$ ,  $R_F = 510\Omega$ ,  $R_L = 25\Omega$ ,  $T_A = 25^\circ C$  unless otherwise specified

PARAMETER	DESCRIPTION	MIN	TYP	MAX	UNITS
SR	Slew Rate (Note 1) (Note 2)	500	1000		V/ $\mu$ s
BW	-3dB Bandwidth (Note 2)		50		MHz
Peaking	(Note 2)		0.3		dB
$t_R, t_F$	Rise Time, Fall Time (Note 2) (Note 3)		7		ns
dG	Differential Gain; DC Input Offset from 0V through +0.714V, AC Amplitude 286mV <sub>P-P</sub> , f = 3.58MHz (Note 4) (Note 2)		0.03		%
dP	Differential Phase; DC Input Offset from 0V through +0.714V, AC Amplitude 286mV <sub>P-P</sub> , f = 3.58MHz (Note 2) (Note 4)		0.05		deg. ( $^\circ$ )

NOTES:

1. Slew Rate is with  $V_{OUT}$  from +5V to -5V and measured at 20% and 80%.
2. All AC tests are performed on a "warmed up" part, except for Slew Rate, which is pulse tested.
3. Rise and Fall Times are with  $V_{OUT}$  between -0.5V and +0.5V and measured at 10% and 90%.
4. See typical performance curves for other conditions.

**Typical Performance Curves** ( $T_A = 25^\circ\text{C}$ ,  $R_L = 25\Omega$ ,  $A_V = +2$ ,  $R_F = 510$  unless otherwise specified)

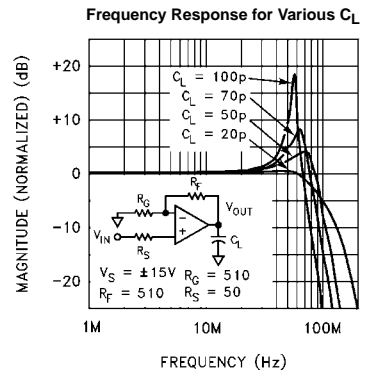
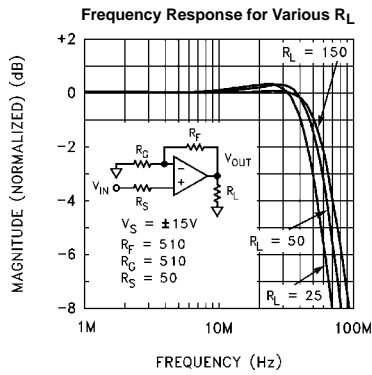
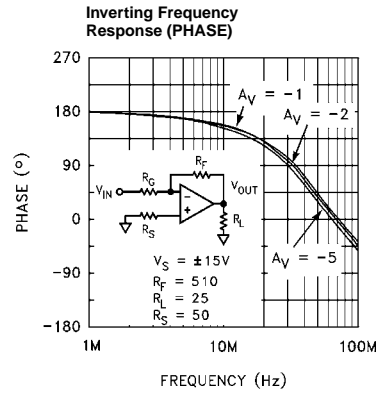
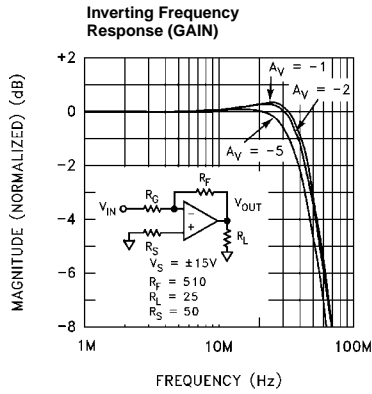
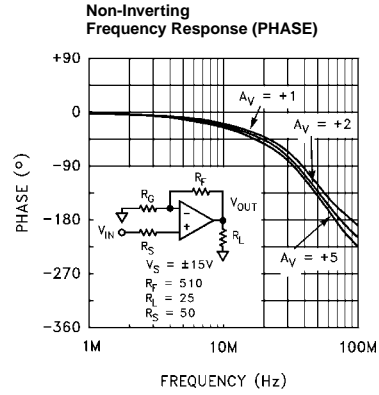
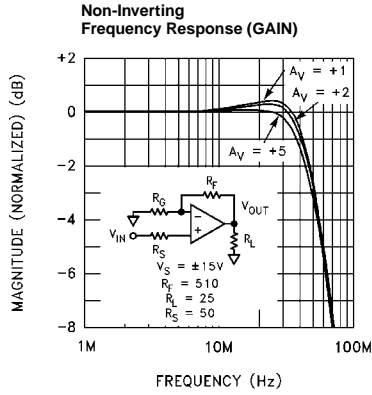

Typical Performance Curves (Continued)

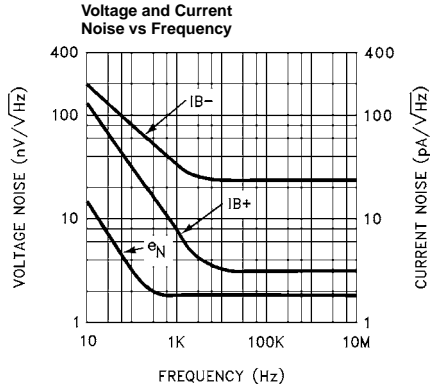
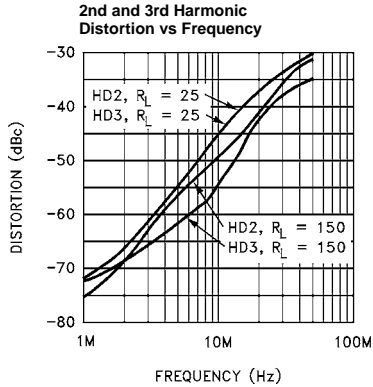
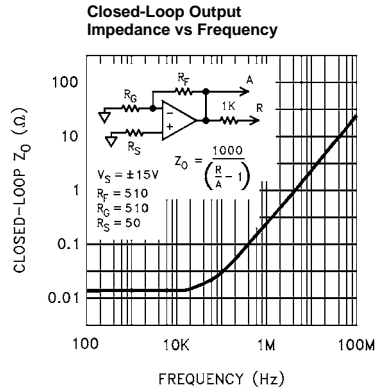
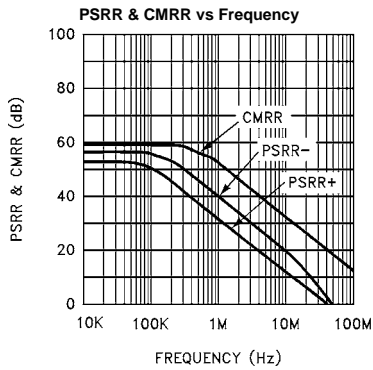
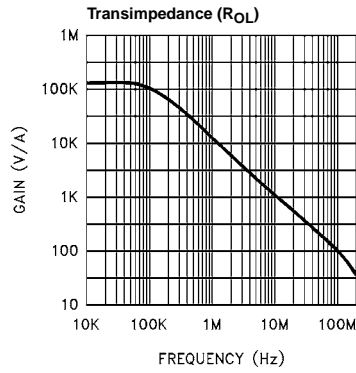
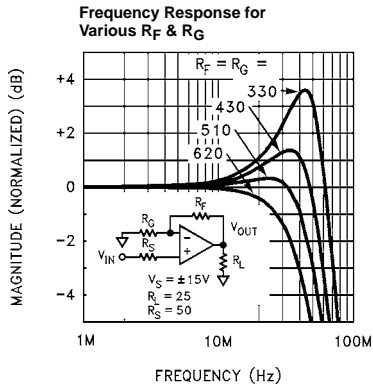

Typical Performance Curves (Continued)

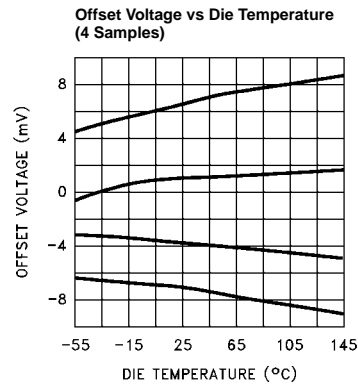
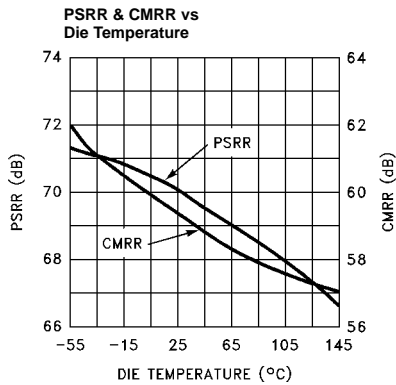
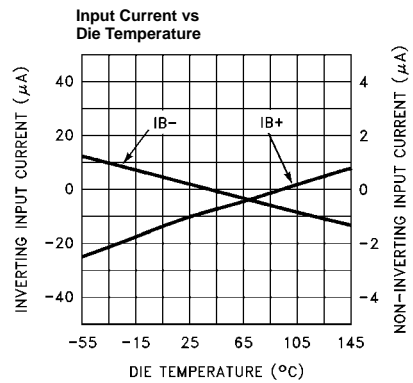
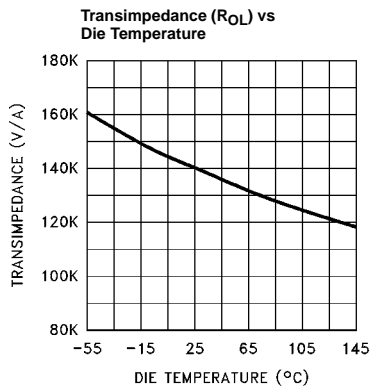
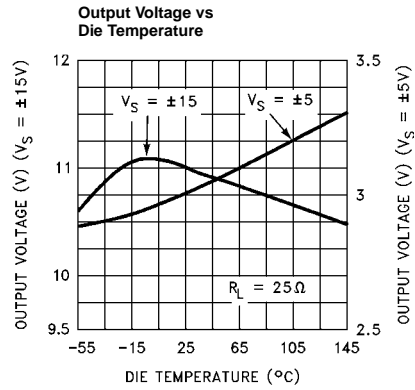
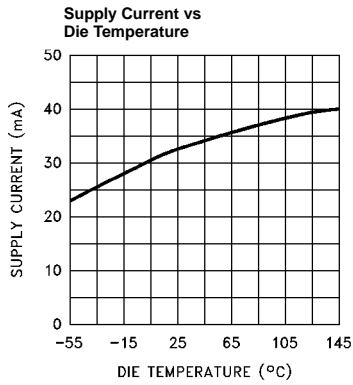

Typical Performance Curves (Continued)

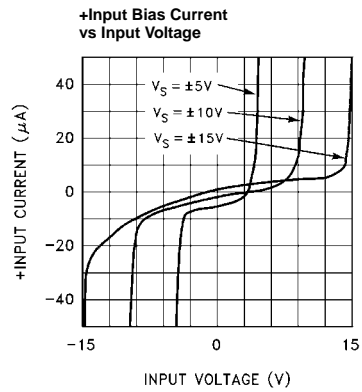
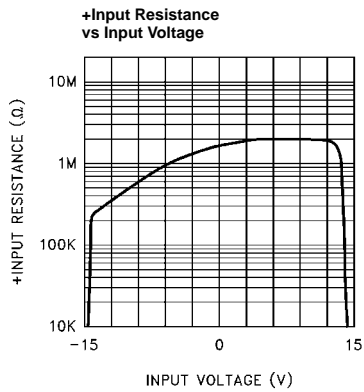
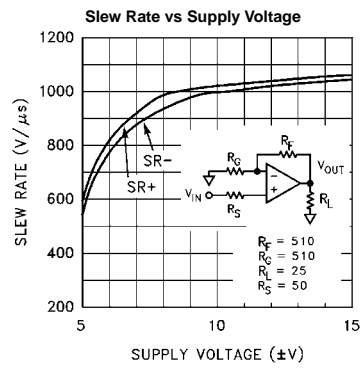
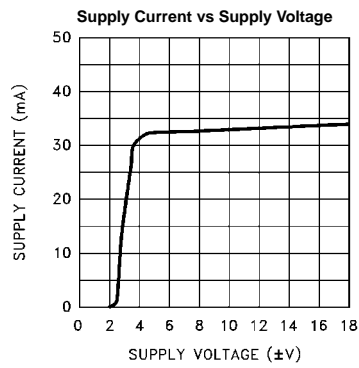
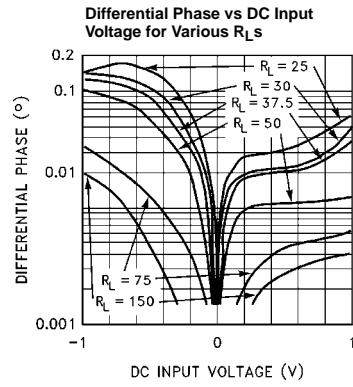
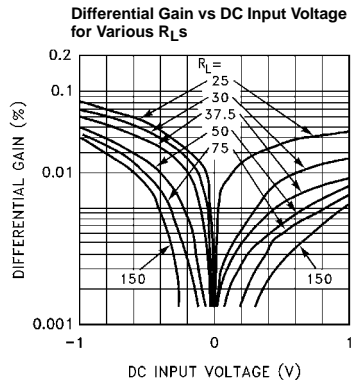

Typical Performance Curves (Continued)

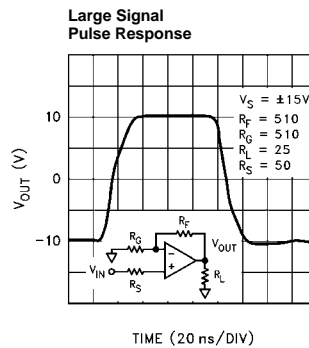
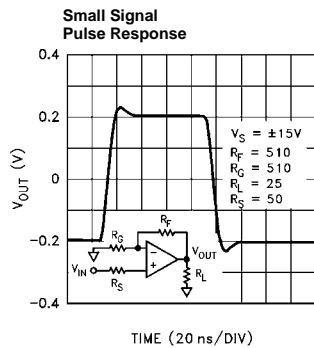
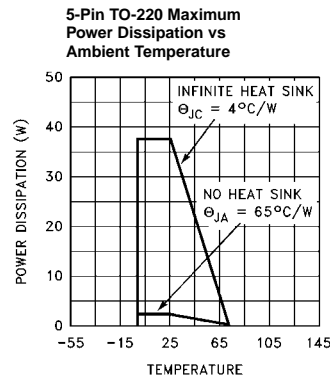
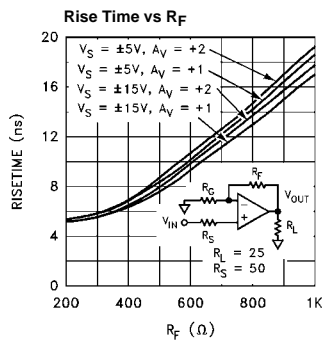
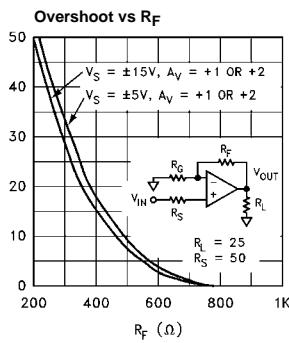
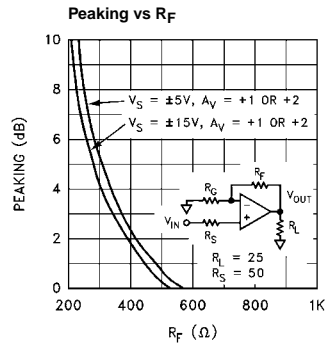
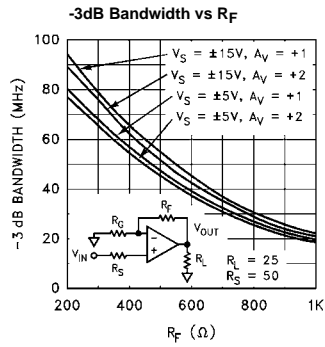



**Simplified Schematic**

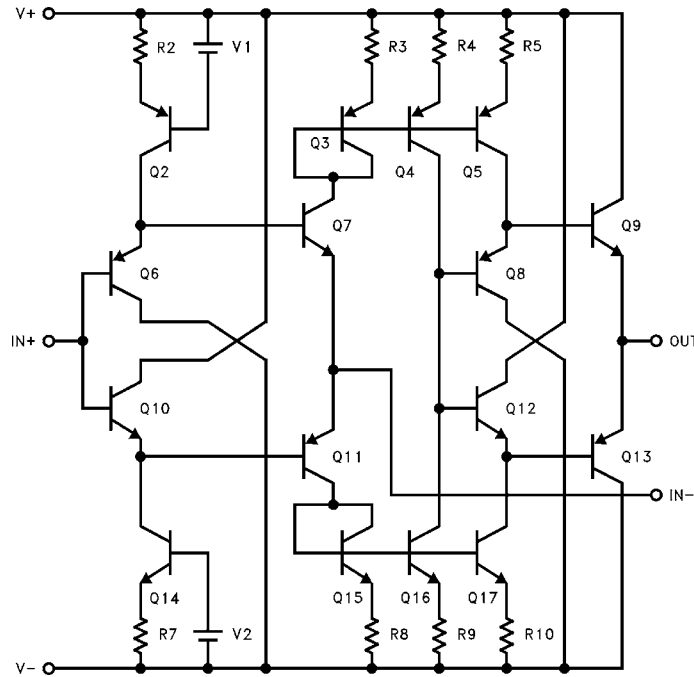

**Burn-In Circuit**

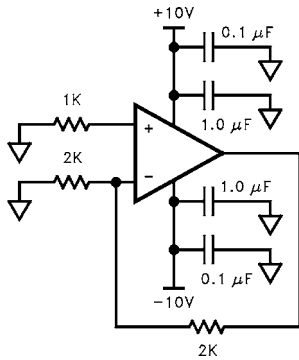

**Applications Information**

**Product Description**

The EL2099 is a current mode feedback amplifier that has high output current drive capability. It is built using Elantec's proprietary dielectric isolation process that produces NPN and PNP complimentary transistors. The high output current can be useful to drive many standard video loads in parallel, as well as digital sync pulses that are 8V or greater.

**+Input Resistor Value**

A small value resistor located in the +Input pin is necessary to keep the EL2099 from oscillating under certain conditions. A 50Ω resistor is recommended for all applications, although

smaller values will work under some circumstances. All tests listed in this datasheet are performed with 50Ω in the +Input pin, as well as all typical performance curves. The 50Ω resistor along with the +Input bias current creates an additional typical Offset Voltage of only 250μV at T = 25°C, and a maximum of 1.25mV over temperature variations.

**Feedback Resistor Values**

The EL2099 has been designed and specified with  $R_F = 510\Omega$  and  $A_V = +2$ . This value of feedback resistor yields extremely flat frequency response with little to no peaking. However, 3dB bandwidth is reduced somewhat because of this. Wider bandwidth, at the expense of slight peaking, can be accomplished by reducing the value of the feedback resistor. For example, at a gain of +2, reducing the feedback resistor to 330Ω increases the -3dB bandwidth to 70MHz with 3dB of peaking. Inversely, larger values of feedback resistor will cause roll off to occur at a lower frequency. There is essentially no peaking with  $R_F > 510\Omega$ .

**Power Supplies**

The EL2099 may be operated with single or split supplies as low as ±5V (10V total) to as high as ±18V (36V total). Bandwidth and slew rate are almost constant from  $V_S = \pm 10V$  to ±18V, and decrease slightly as supplies are reduced to ±5V, as shown in the characteristic curves. It is not necessary to use equal value split supplies. For example, -5V and -12V would be fine for 0V to 1V video signals.

Good power supply bypassing should be used to reduce the risk of oscillation. A 1 $\mu$ F to 10 $\mu$ F tantalum capacitor in parallel with a 0.1 $\mu$ F ceramic capacitor is recommended for bypassing each supply pin. They should be kept as close as possible to the device pins.

Due to the internal construction of the TO-220 package, the tab of the EL2099 is connected to the V<sub>S-</sub> pin. Therefore, care must be taken to avoid connecting the tab to the ground plane of the system.

**Printed Circuit Board Layout**

As with any high frequency device, good printed circuit board layout is necessary for optimum performance. Ground plane construction is highly recommended. Pin lengths should be as short as possible. For good AC performance, parasitic capacitances should be kept to a minimum, especially at the inverting input, which is sensitive to stray capacitance. This implies keeping the ground plane away from this pin. Metal film and carbon resistors are both acceptable, while use of wire-wound resistors is not recommended because of their parasitic inductance. Similarly, capacitors should be low inductance for best performance.

**Driving Cables and Capacitive Loads**

The EL2099 was designed with driving multiple coaxial cables in mind. With 440mA of output drive and low output impedance, driving six, 75 $\Omega$  double terminated coaxial cables to  $\pm$ 11V with one EL2099 is practical.

When used as a cable driver, double termination is always recommended for reflection-free performance. For those applications, the back termination series resistor will decouple the EL2099 from the capacitive cable and allow extensive capacitive drive. For a discussion on some of the other ways to drive cables, see the application section on driving cables in the EL2003 data sheet.

Other applications may have high capacitive loads without termination resistors. In these applications, an additional small value (5 $\Omega$ -50 $\Omega$ ) resistor in series with the output will eliminate most peaking.

The schematic below shows the EL2099 driving 6 double terminated cables, each of average length of 50 feet.

This represents driving an effective load of 25 $\Omega$  to over  $\pm$ 10V. The resulting performance is shown in the scope photo. Notice that double termination results in reflection free performance.

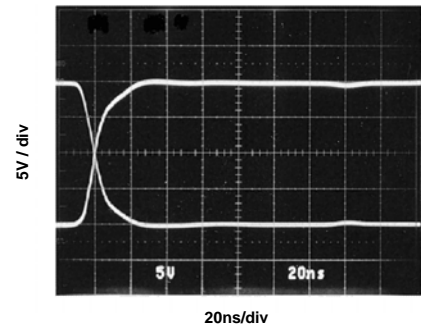
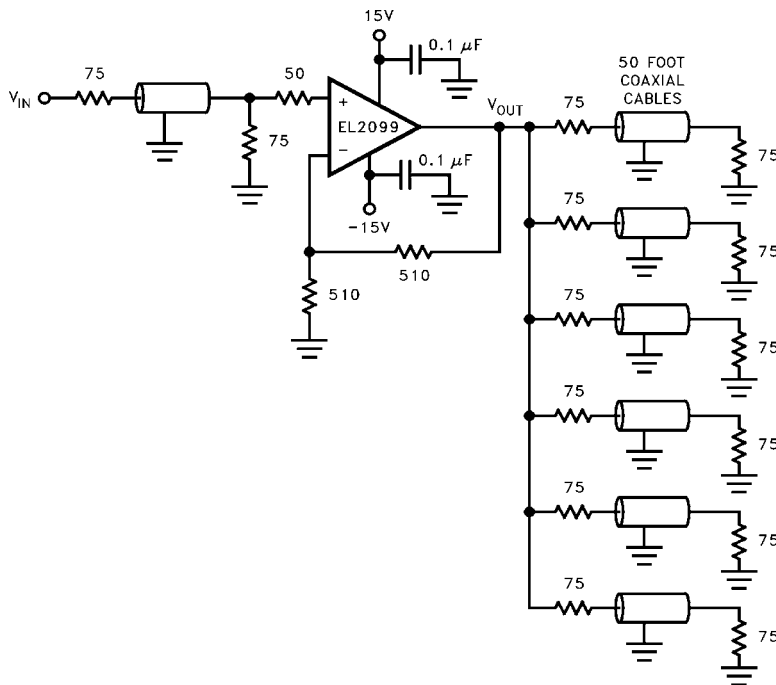

**EL2099 Macromodel**

```

* Connections:  +input
*               | -input
*               | | +Vsupply
*               | | -Vsupply
*               | | | output
*               | | | |
.subckt M2099 4 5 1 3 2
*

```

## \* Input Stage

```

*
e1 10 0 4 0 1.0
vis 10 9 0V
h2 9 12 vxx 1.0
r1 5 11 50
l1 11 12 48nH
iinp 4 0 5μA
iinm 5 0 -8μA
*

```

## \* Slew Rate Limiting

```

*
h1 13 0 vis 600
r2 13 14 1K
d1 14 0 dclamp
d2 0 14 dclamp
*

```

## \* High Frequency Pole

```

*
*e2 30 0 14 0 0.001667
13 30 17 1.5μH
c5 17 0 1pF
r5 17 0 500
*

```

## \* Transimpedance Stage

```

*
g1 0 18 17 0 1.0
ro1 18 0 150K
cdp 18 0 8pF
*

```

## \* Output Stage

```

*
q1 3 18 19 qp
q2 1 18 20 qn
q3 1 19 21 qn
q4 3 20 22 qp
r7 21 2 1
r8 22 2 1
ios1 1 19 5mA
ios2 20 3 5mA
*

```

## \* Supply Current

```

*
ips 1 3 19mA
*

```

## \* Error Terms

```

*
ivos 0 23 5mA
vxx 23 0 0V
e4 24 0 2 0 1.0
e5 25 0 1 0 1.0

```

**EL2099 Macromodel** (Continued)

e6 26 0 3 0 1.0  
 r9 24 23 3K  
 r10 25 23 1K  
 r11 26 23 1K

\* Models

\*

.model qn npn (is=5e-15 bf=200 tf=0.1nS)  
 .model qp pnp (is=5e-15 bf=200 tf=0.1nS)  
 .model dclamp d (is=1e-30 ibv=0.266 bv=5 n=4)  
 .ends

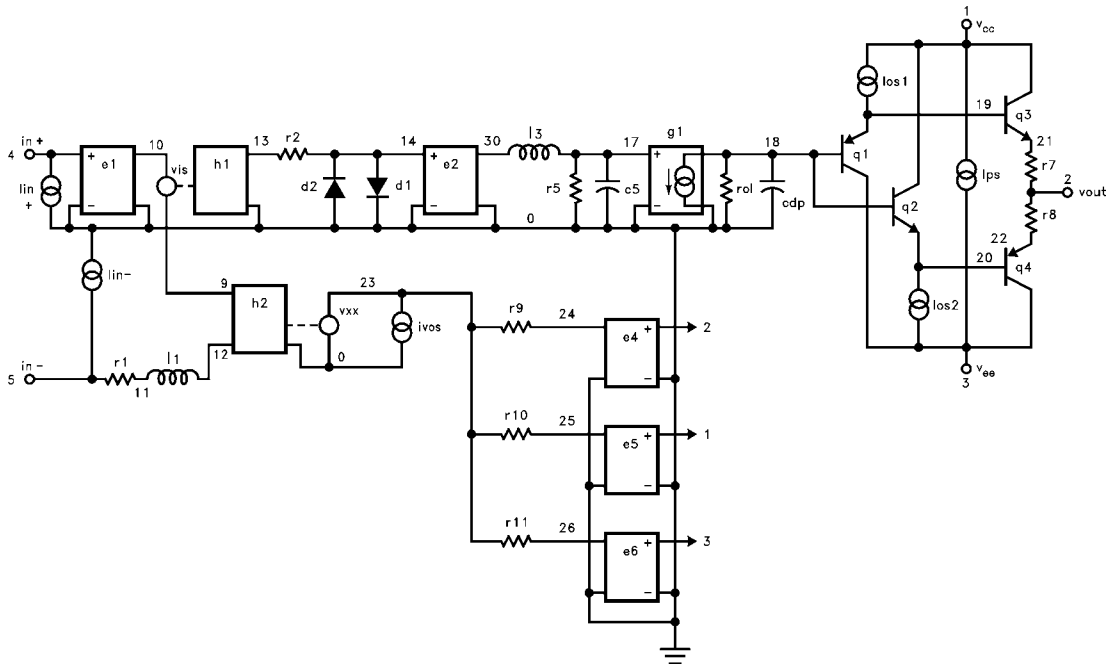

All Intersil U.S. products are manufactured, assembled and tested utilizing ISO9000 quality systems.  
 Intersil Corporation's quality certifications can be viewed at [www.intersil.com/design/quality](http://www.intersil.com/design/quality)

*Intersil products are sold by description only. Intersil Corporation reserves the right to make changes in circuit design, software and/or specifications at any time without notice. Accordingly, the reader is cautioned to verify that data sheets are current before placing orders. Information furnished by Intersil is believed to be accurate and reliable. However, no responsibility is assumed by Intersil or its subsidiaries for its use; nor for any infringements of patents or other rights of third parties which may result from its use. No license is granted by implication or otherwise under any patent or patent rights of Intersil or its subsidiaries.*

For information regarding Intersil Corporation and its products, see [www.intersil.com](http://www.intersil.com)