

**Features**

1. Opaque type, mini-flat package.
2. Subminiature type  
(The volume is smaller than that of our conventional DIP type by as far as 30%)
3. Isolation voltage between input and output (Viso:2500Vrms).

**For 115/240 Vac (rms) Application:**

1. Solenoid/Valve Controls.
2. Lighting Controls.
3. Static Power Switches.
4. AC Motor Drives.
5. Temperature Controls.
6. E.M. Contactors.
7. AC Motor Staters.
8. Solid State Relays.
9. Programmable controllers.

**Outside Dimension:Unit (mm)**

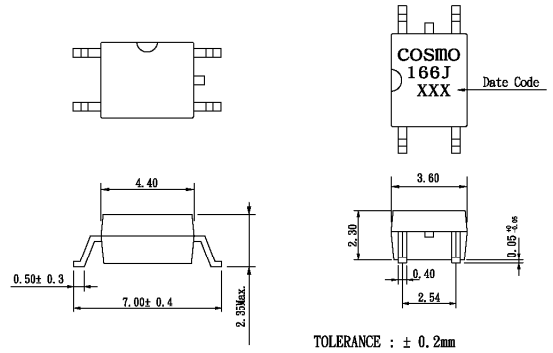

**Schematic:Top View**

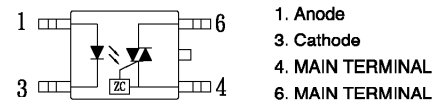

**Absolute Maximum Ratings**

(Ta=25°C)

Parameter		Symbol	Rating	Unit
Input	Forward current	IF	50	mA
	Peak forward current (100us)	IFM	1	A
	Reverse voltage	VR	6	V
	Power dissipation	Pd	70	mW
Output	Off-State Output Terminal voltage	VDRM	600	Vpeak
	On-State R. M. S. Current	IT(RMS)	70	mA
	Peak Repetitive Surget Current (PW=10ms, DC 10%)	ITSM	1	A
	Power dissipation	Pd	150	mW
Total power dissipation		Ptot	200	mW
Isolation voltage 1 minute		Viso	2500	Vrms
Operating temperature		Topr	-40 to +100	°C
Storage temperature		Tstg	-50 to +125	°C
Soldering temperature 10 second		Tsol	260	°C

**Electro-optical Characteristics**

(Ta=25°C)

Parameter		Symbol	Conditions	MIN.	TYP.	MAX.	Unit
Input	Forward voltage	VF	IF=10mA	—	1.2	1.4	V
	Peak forward voltage	VFM	IFM=0.5A	—	—	3.5	V
	Reverse Leakage Current	IR	VR=5V	—	—	10	µA
Output	Peak Blocking Current	IDRM	VDRM=600V	—	—	1.0	µA
	ON-State Voltage	VTM	ITM=70mA	—	1.6	2.8	V
Transfer characteristics	Holding Current	IH	—	—	1.0	—	mA
	Critical rate of rise of OFF-state voltage	dV/dt	VDRM= (1/√2) *Rated	600	—	—	V/µS
	Isolation resistance	Riso	DC500V	5x10 <sup>10</sup>	10 <sup>11</sup>	—	ohm
	Minimum trigger current	IFT	Main Terminal Voltage=3V	—	5	10	mA
	Inhibit Voltage (MT2 Voltage above which device not trigger.)	VINH	IF=Rated IFT	—	—	50	V
	Leakage in Inhibited State	IDRM2	IF=Rated IFT, VT=Rated VDRM	—	—	600	µA

Classification table of Trigger LED current is shown below.

(Ta=25°C)

Classification	Trigger LED Current (mA)	
	Min.	Max.
1 (Standard)	-	10
2	-	7
3	-	5

Fig.1 Forward Current vs. Ambient Temperature

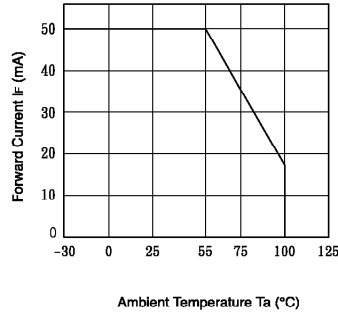

Fig.2 Diode Power Dissipation vs. Ambient Temperature

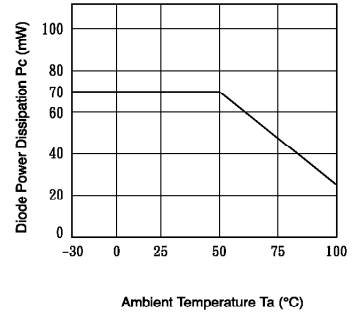

Fig.3 On-State R. M. S. Current vs. Ambient Temperature

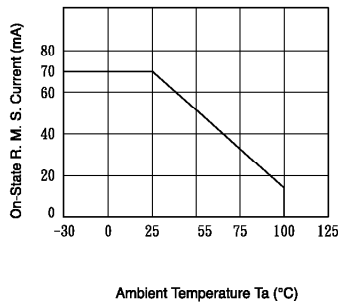

Fig.4 Total Power Dissipation vs. Ambient Temperature

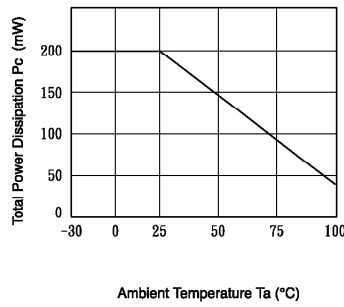

Fig.5 Peak Forward Current vs. Duty Ratio

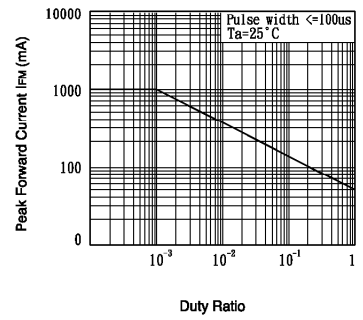

Fig.6 Forward Current vs. Forward Voltage

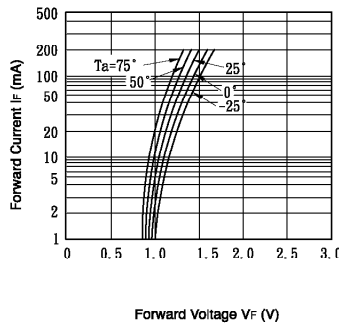

Fig.7 On-State Characteristics

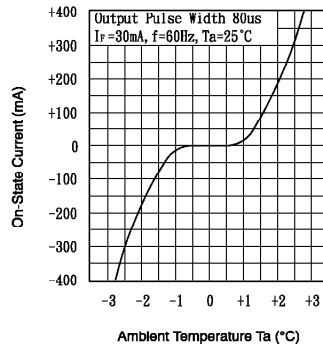

Fig.8 Leakage with LED off vs. Ambient Temperature

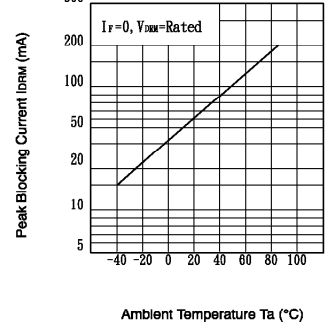

Fig.9 Trigger Current vs. Ambient Temperature

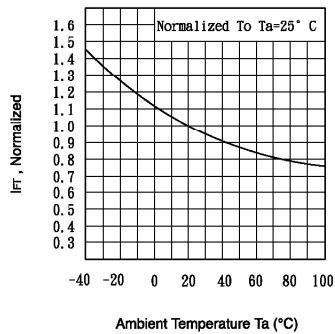

Fig.10 Inhibit Voltage vs. Ambient Temperature

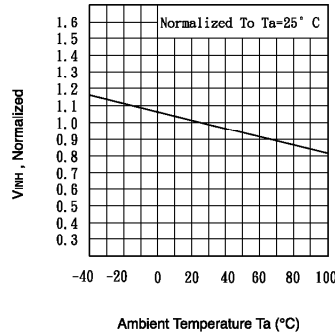

Fig.11 Ibrm2, Leakage in Inhibit vs. Ambient Temperature

