

Product Preview
**Low Voltage 1:27 Clock
Distribution Chip**

The MPC941 is a 1:27 low voltage clock distribution chip. The device features the capability to select either a differential LVPECL or an LVTTTL/LVCMOS compatible input. The 27 outputs are LVCMOS or LVTTTL compatible and feature the drive strength to drive 50Ω series or parallel terminated transmission lines. With output-to-output skews of 250ps, the MPC941 is ideal as a clock distribution chip for the most demanding of synchronous systems. For a similar product with a smaller number of outputs, please consult the MPC940 data sheet.

- LVPECL or LVCMOS/LVTTTL Clock Input
- 250ps Maximum Targeted Output-to-Output Skew
- Drives Up to 54 Independent Clock Lines
- Maximum Output Frequency of 250MHz
- High Impedance Output Enable
- 52-Lead TQFP Packaging
- 3.3V V_{CC} Supply Voltage

With a low output impedance, in both the HIGH and LOW logic states, the output buffers of the MPC941 are ideal for driving series terminated transmission lines. More specifically, each of the 27 MPC941 outputs can drive two series terminated 50Ω transmission lines. With this capability, the MPC941 has an effective fanout of 1:54 in applications where each line drives a single load. With this level of fanout, the MPC941 provides enough copies of low skew clocks for most high performance synchronous systems.

The differential LVPECL inputs of the MPC941 allow the device to interface directly with a LVPECL fanout buffer like the MC100EP111 to build very wide clock fanout trees or to couple to a high frequency clock source. The LVCMOS/LVTTTL input provides a more standard interface for applications requiring only a single clock distribution chip at relatively low frequencies. In addition, the two clock sources can be used to provide for a test clock interface as well as the primary system clock. A logic HIGH on the LVCMOS_CLK_Sel pin will select the TTL level clock input.

The MPC941 is fully 3.3V compatible. The 52-lead TQFP package was chosen to optimize performance, board space and cost of the device. The 52-lead TQFP has a 10x10mm body size with a conservative 0.65mm pin spacing.

MPC941

**LOW VOLTAGE
1:27 CLOCK
DISTRIBUTION CHIP**



FA SUFFIX
52-LEAD TQFP PACKAGE
CASE 848D-03



LOGIC DIAGRAM



Pinout: 52-Lead TQFP (Top View)

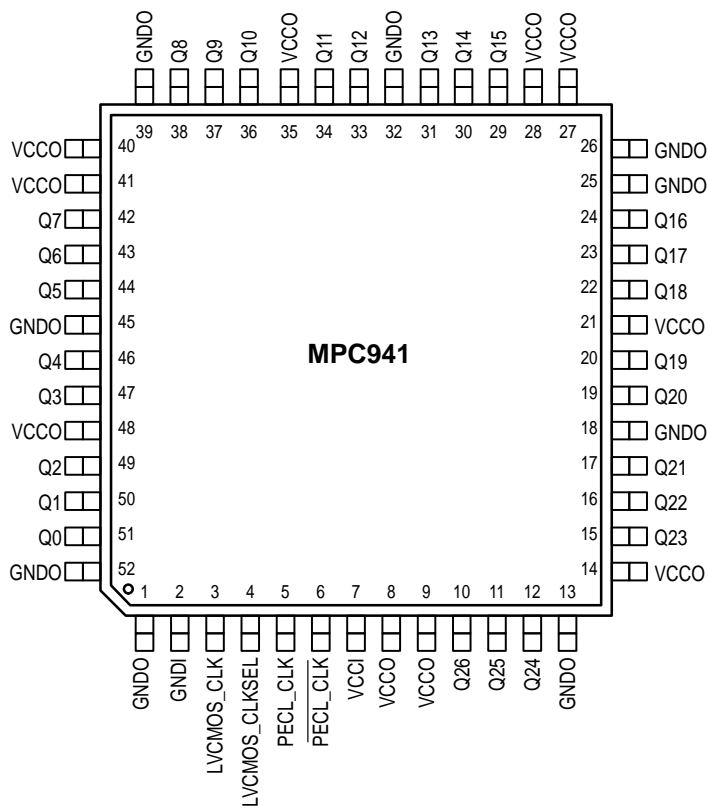

FUNCTION TABLE

LVC MOS_CLK_Sel	Input
0	PECL_CLK
1	LVC MOS_CLK

ABSOLUTE MAXIMUM RATINGS*

Symbol	Parameter	Min	Max	Unit
V _{CC}	Supply Voltage	-0.3	3.6	V
V _I	Input Voltage	-0.3	V _{DD} + 0.3	V
I _{IN}	Input Current		±20	mA
T _{Stor}	Storage Temperature Range	-40	125	°C

* Absolute maximum continuous ratings are those values beyond which damage to the device may occur. Exposure to these conditions or conditions beyond those indicated may adversely affect device reliability. Functional operation under absolute-maximum-rated conditions is not implied.

DC CHARACTERISTICS (T_A = 0° to 70°C, V_{CC} = 3.3V ±5%)

Symbol	Characteristic	Min	Typ	Max	Unit	Condition
V _{IH}	Input HIGH Voltage PECL_CLK Other				V	
V _{IL}	Input LOW Voltage PECL_CLK Other				V	
V _{PP}	Peak-to-Peak Input Voltage PECL_CLK				mV	
V _{CMR}	Common Mode Range PECL_CLK				V	
V _{OH}	Output HIGH Voltage				V	Note NO TAG
V _{OL}	Output LOW Voltage				V	Note NO TAG
I _{IN}	Input Current				μA	
C _{IN}	Input Capacitance				pF	
C _{pd}	Power Dissipation Capacitance				pF	
I _{CC}	Maximum Quiescent Supply Current				mA	

1. The MPC941 outputs can drive series or parallel terminated 50Ω (or 50Ω to V_{CC}/2) transmission lines on the incident edge.

AC CHARACTERISTICS (T_A = 0° to 70°C, V_{CC} = 3.3V ±5%)

Symbol	Characteristic	Min	Typ	Max	Unit	Condition
F _{max}	Maximum Input Frequency		250		MHz	Note NO TAG
t _{pd}	Propagation Delay PECL_CLK to Q TTL_CLK to Q		3.0 3.0		ns	Note NO TAG
t _{sk(o)}	Output-to-Output Skew		250		ps	Note NO TAG
t _{sk(pr)}	Part-to-Part Skew PECL_CLK to Q TTL_CLK to Q		650 650		ps	Note NO TAG
t _{pwo}	Output Pulse Width		t _{CYCLE} /2 ±500		ps	Note NO TAG, Measured at V _{CC} /2
t _r , t _f	Output Rise/Fall Time	0.20		1.0	ns	0.8V to 2.0V

2. Driving 50Ω transmission lines.

3. Part-to-part skew at a given temperature and voltage.

OUTLINE DIMENSIONS

FA SUFFIX
PLASTIC TQFP PACKAGE
CASE 848D-03
ISSUE C

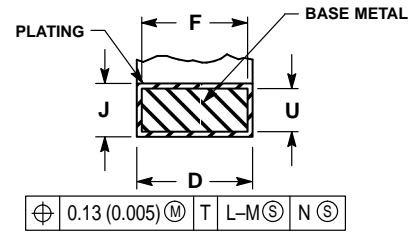
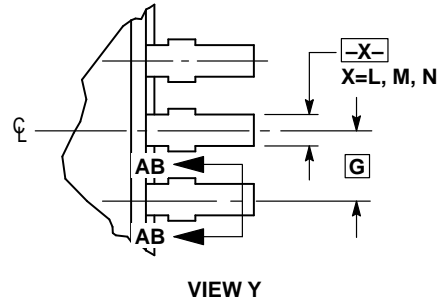
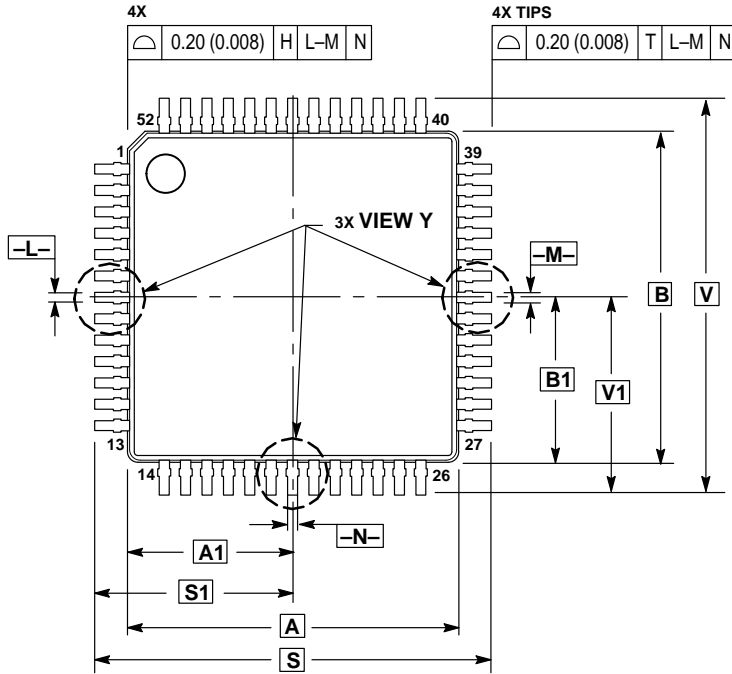

SECTION AB-AB
ROTATED 90° CLOCKWISE

NOTES:

1. DIMENSIONING AND TOLERANCING PER ANSI Y14.5M, 1982.
2. CONTROLLING DIMENSION: MILLIMETER.
3. DATUM PLANE -H- IS LOCATED AT BOTTOM OF LEAD AND IS COINCIDENT WITH THE LEAD WHERE THE LEAD EXITS THE PLASTIC BODY AT THE BOTTOM OF THE PARTING LINE.
4. DATUMS -L-, -M- AND -N- TO BE DETERMINED AT DATUM PLANE -H-.
5. DIMENSIONS S AND V TO BE DETERMINED AT SEATING PLANE -T-.
6. DIMENSIONS A AND B DO NOT INCLUDE MOLD PROTRUSION. ALLOWABLE PROTRUSION IS 0.25 (0.010) PER SIDE. DIMENSIONS A AND B DO INCLUDE MOLD MISMATCH AND ARE DETERMINED AT DATUM PLANE -H-.
7. DIMENSION D DOES NOT INCLUDE DAMBAR PROTRUSION. DAMBAR PROTRUSION SHALL NOT CAUSE THE LEAD WIDTH TO EXCEED 0.46 (0.018). MINIMUM SPACE BETWEEN PROTRUSION AND ADJACENT LEAD OR PROTRUSION 0.07 (0.003).

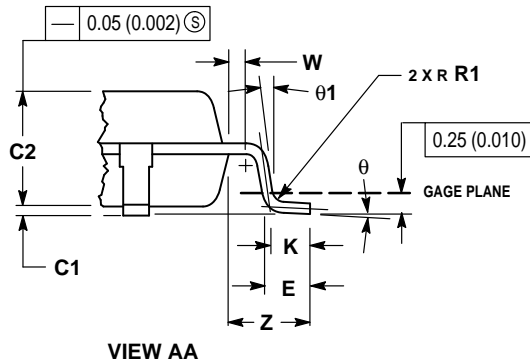
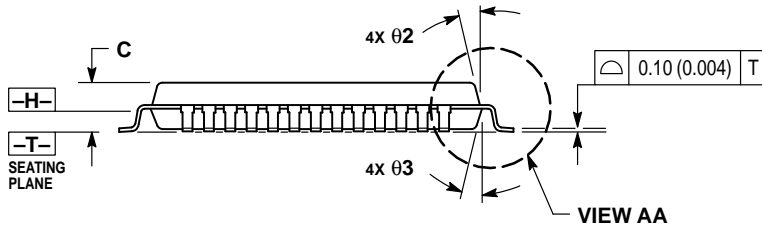

DIM	MILLIMETERS		INCHES	
	MIN	MAX	MIN	MAX
A	10.00 BSC	—	0.394 BSC	—
A1	5.00 BSC	—	0.197 BSC	—
B	10.00 BSC	—	0.394 BSC	—
B1	5.00 BSC	—	0.197 BSC	—
C	—	1.70	—	0.067
C1	0.05	0.20	0.002	0.008
C2	1.30	1.50	0.051	0.059
D	0.20	0.40	0.008	0.016
E	0.45	0.75	0.018	0.030
F	0.22	0.35	0.009	0.014
G	0.65 BSC	—	0.026 BSC	—
J	0.07	0.20	0.003	0.008
K	0.50 REF	—	0.020 REF	—
R1	0.08	0.20	0.003	0.008
S	12.00 BSC	—	0.472 BSC	—
S1	6.00 BSC	—	0.236 BSC	—
U	0.09	0.16	0.004	0.006
V	12.00 BSC	—	0.472 BSC	—
V1	6.00 BSC	—	0.236 BSC	—
W	0.20 REF	—	0.008 REF	—
Z	1.00 REF	—	0.039 REF	—
Ø	0°	7°	0°	7°
Ø1	0°	—	0°	—
Ø2	12° REF	—	12° REF	—
Ø3	5°	13°	5°	13°

Motorola reserves the right to make changes without further notice to any products herein. Motorola makes no warranty, representation or guarantee regarding the suitability of its products for any particular purpose, nor does Motorola assume any liability arising out of the application or use of any product or circuit, and specifically disclaims any and all liability, including without limitation consequential or incidental damages. "Typical" parameters which may be provided in Motorola data sheets and/or specifications can and do vary in different applications and actual performance may vary over time. All operating parameters, including "Typicals" must be validated for each customer application by customer's technical experts. Motorola does not convey any license under its patent rights nor the rights of others. Motorola products are not designed, intended, or authorized for use as components in systems intended for surgical implant into the body, or other applications intended to support or sustain life, or for any other application in which the failure of the Motorola product could create a situation where personal injury or death may occur. Should Buyer purchase or use Motorola products for any such unintended or unauthorized application, Buyer shall indemnify and hold Motorola and its officers, employees, subsidiaries, affiliates, and distributors harmless against all claims, costs, damages, and expenses, and reasonable attorney fees arising out of, directly or indirectly, any claim of personal injury or death associated with such unintended or unauthorized use, even if such claim alleges that Motorola was negligent regarding the design or manufacture of the part. Motorola and  are registered trademarks of Motorola, Inc. Motorola, Inc. is an Equal Opportunity/Affirmative Action Employer.

How to reach us:

USA/EUROPE/Locations Not Listed: Motorola Literature Distribution;
P.O. Box 5405; Denver, Colorado 80217. 303-675-2140 or 1-800-441-2447

Mfax™: RMFAX0@email.sps.mot.com – TOUCHTONE 602-244-6609
INTERNET: <http://www.mot.com/sps/>

JAPAN: Nippon Motorola Ltd.; Tatsumi-SPD-JLDC, 6F Seibu-Butsuryu-Center,
3-14-2 Tatsumi Koto-Ku, Tokyo 135, Japan. 81-3-3521-8315

ASIA/PACIFIC: Motorola Semiconductors H.K. Ltd.; 8B Tai Ping Industrial Park,
51 Ting Kok Road, Tai Po, N.T., Hong Kong. 852-26629298

