



Micro Commercial Components
 21201 Itasca Street Chatsworth
 CA 91311
 Phone: (818) 701-4933
 Fax: (818) 701-4939

MPSA13 MPSA14

NPN Silicon Darlington Transistor

Features

- Capable of 1.5Watts of Power Dissipation.
- Collector-current 500mA
- Collector-base Voltage 30V
- Operating and storage junction temperature range: -55°C to +150°C

Pin Configuration
Bottom View

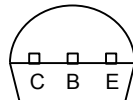

Maximum Ratings

Symbol	Rating	Rating	Unit
V _{CES}	Collector-Emitter Voltage	30	V
V _{CBO}	Collector-Base Voltage	30	V
V _{EBO}	Emitter-Base Voltage	10	V
I _C	Collector Current Continuous	500	mA
P _D	Total Device Dissipation @ T _A =25°C	625	mW
	Derate above 25°C	5.0	mW/°C
P _D	Total Device Dissipation @ T _A =25°C	1.5	W
	Derate above 25°C	12	mW/°C
T _J	Junction Temperature	-55 to +150	°C
T _{STG}	Storage Temperature	-55 to +150	°C

Electrical Characteristics @ 25°C Unless Otherwise Specified

Symbol	Parameter	Min	Max	Units
--------	-----------	-----	-----	-------

OFF CHARACTERISTICS

V _{(BR)CES}	Collector-Emitter Breakdown Voltage (I _C =100uAdc, I _B =0)	30		Vdc
I _{CBO}	Collector Cutoff Current (V _{CB} =30Vdc, I _E =0)		100	nAdc
I _{EBO}	Emitter Cutoff Current (V _{EB} =10Vdc, I _C =0)		100	nAdc

ON CHARACTERISTICS⁽¹⁾

h _{FE(1)}	DC Current Gain (I _C =10mAdc, V _{CE} =5.0Vdc)	MPSA13 MPSA14	5000 10000		
h _{FE(2)}	DC Current Gain (I _C =100mAdc, V _{CE} =5.0Vdc)	MPSA13 MPSA14	10000 20000		
V _{CE(sat)}	Collector-Emitter Saturation Voltage (I _C =100mAdc, I _B =0.1mAdc)			1.5	Vdc
V _{BE(on)}	Base-Emitter Saturation Voltage (I _C =100mAdc, V _{CE} =5.0Vdc)			2.0	Vdc

SMALL-SIGNAL CHARACTERISTICS

f _T	Current-Gain – Bandwidth Product ⁽²⁾ (I _C =10mAdc, V _{CE} =5.0Vdc, f=100MHz)	125			MHz
----------------	--	-----	--	--	-----

1. Pulse Test: Pulse Width<300us, Duty Cycle<2.0%

2. f_T=|h_{fe}| x f_{test}

TO-92

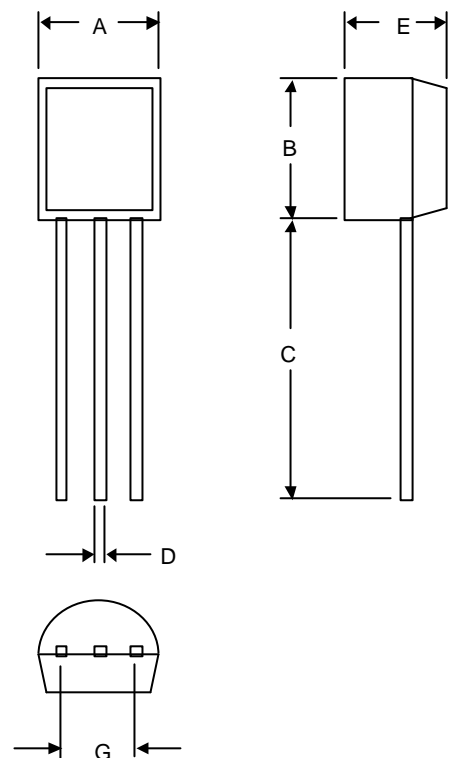

DIM	INCHES		MM		NOTE
	MIN	MAX	MIN	MAX	
A	.175	.185	4.45	4.70	
B	.175	.185	4.46	4.70	
C	.500	---	12.7	---	
D	.016	.020	0.41	0.63	
E	.135	.145	3.43	3.68	
G	.095	.105	2.42	2.67	

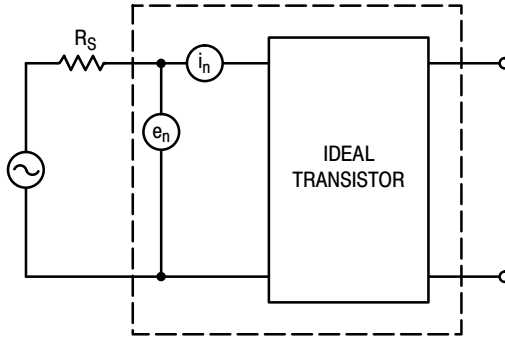

Figure 1. Transistor Noise Model

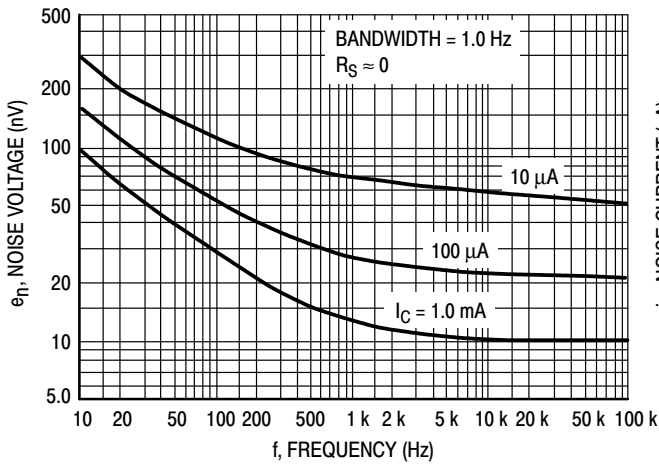

Figure 2. Noise Voltage

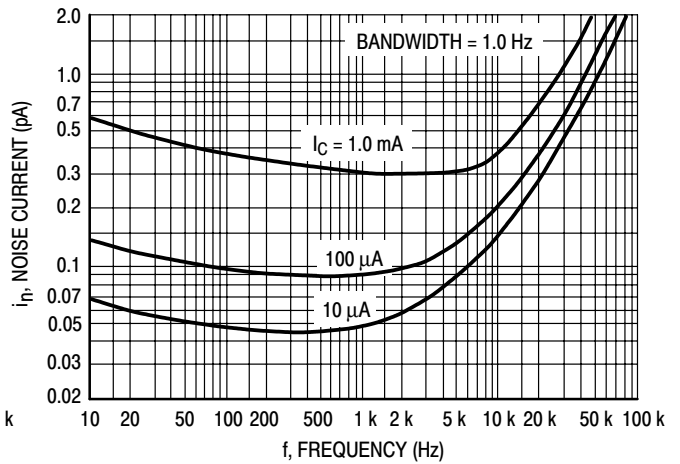

Figure 3. Noise Current

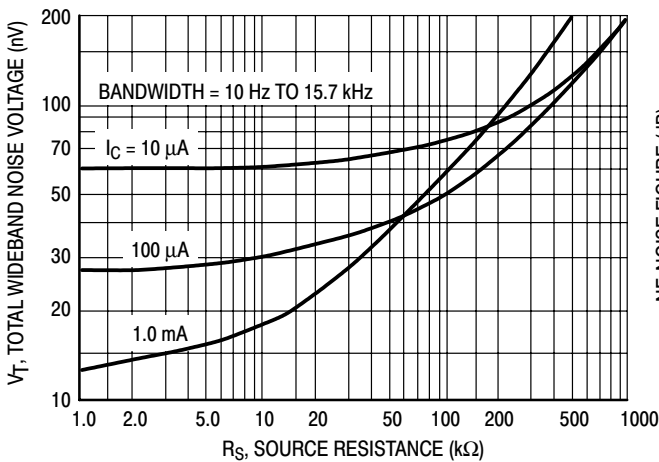

Figure 4. Total Wideband Noise Voltage

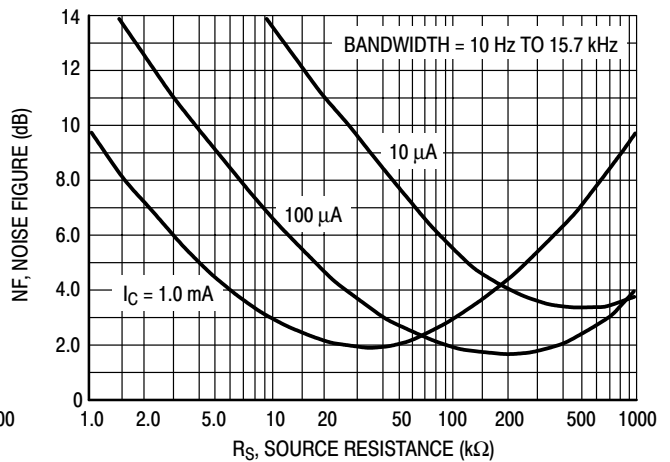

Figure 5. Wideband Noise Figure

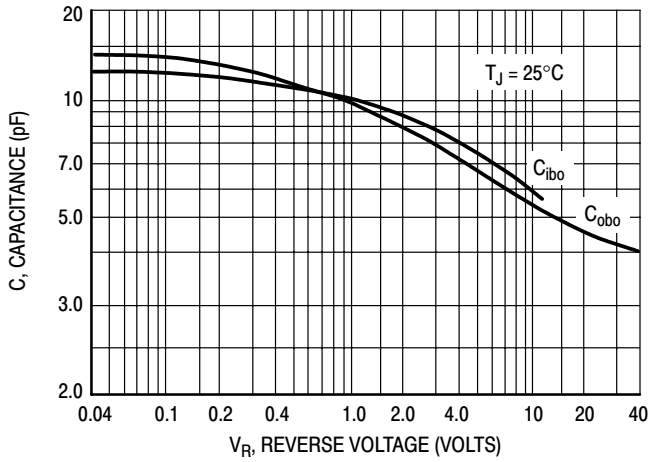

Figure 6. Capacitance

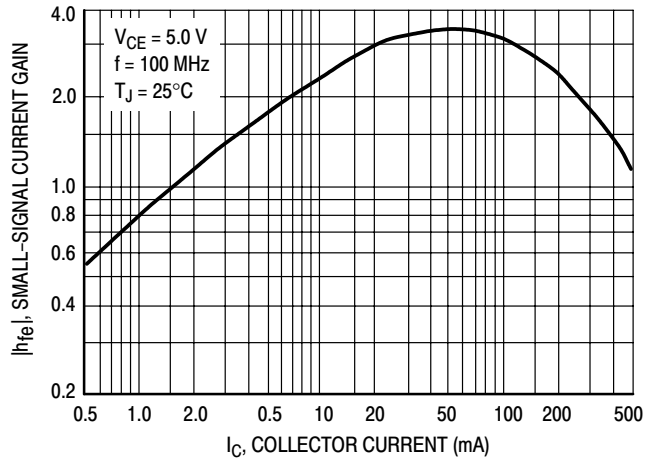

Figure 7. High Frequency Current Gain

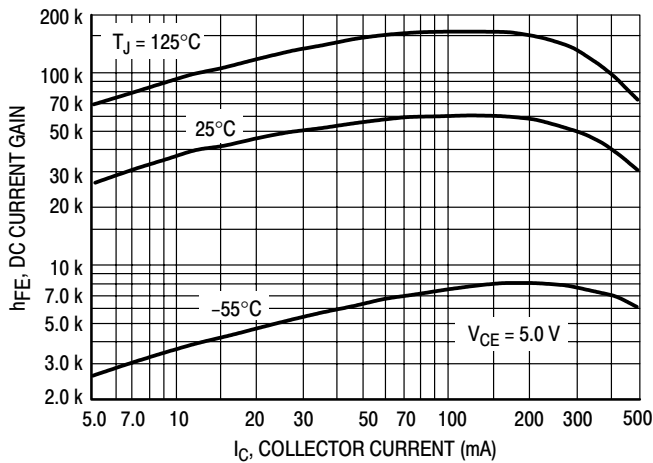

Figure 8. DC Current Gain

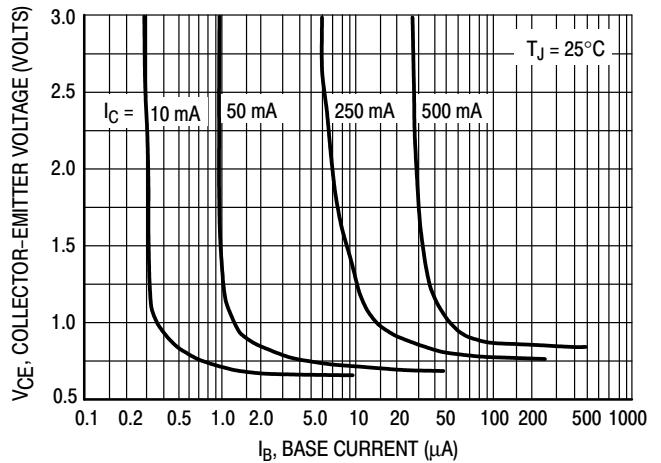

Figure 9. Collector Saturation Region

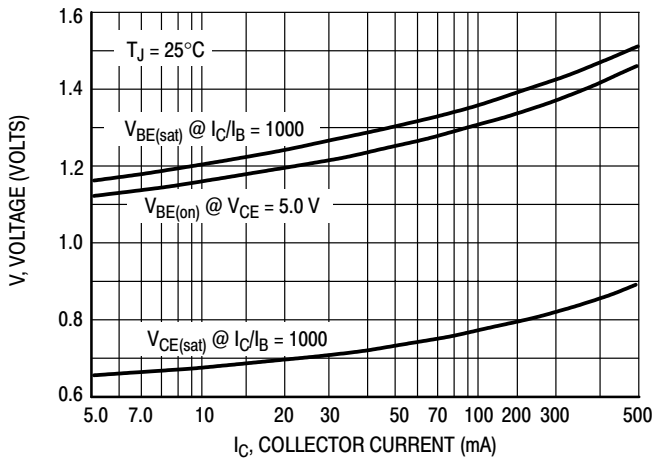

Figure 10. "On" Voltages

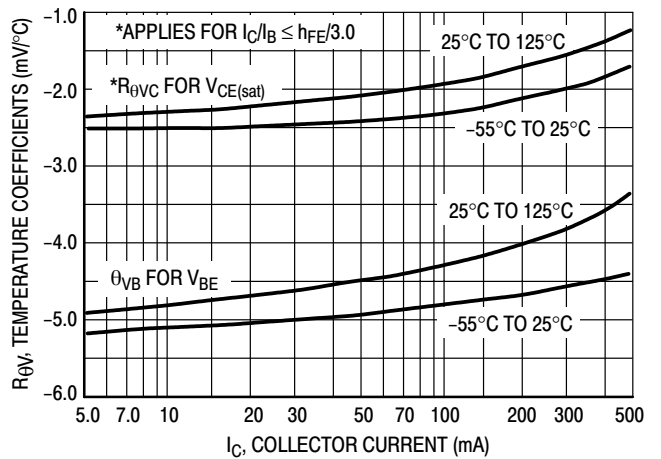

Figure 11. Temperature Coefficients

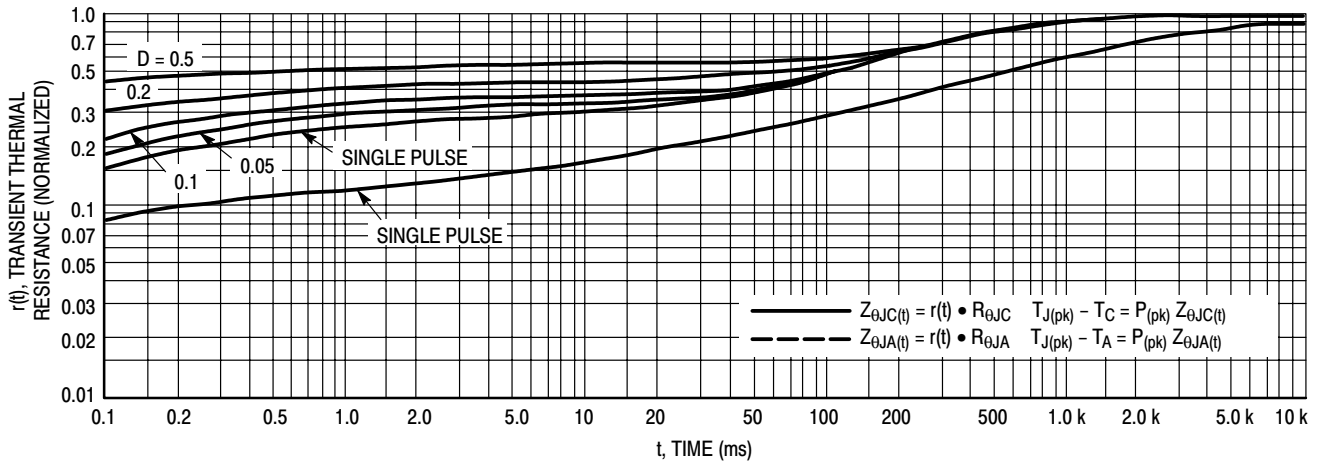

Figure 12. Thermal Response

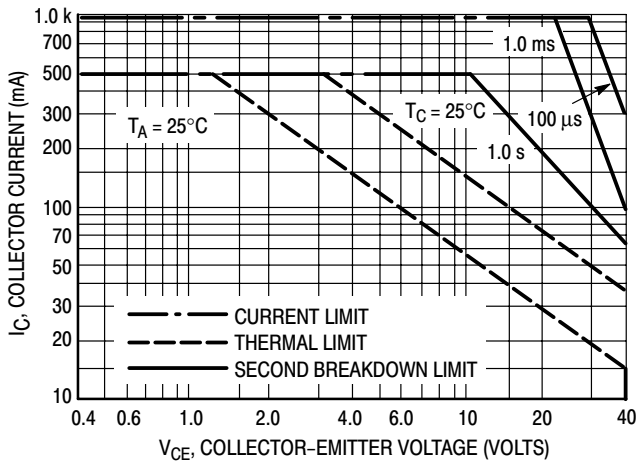
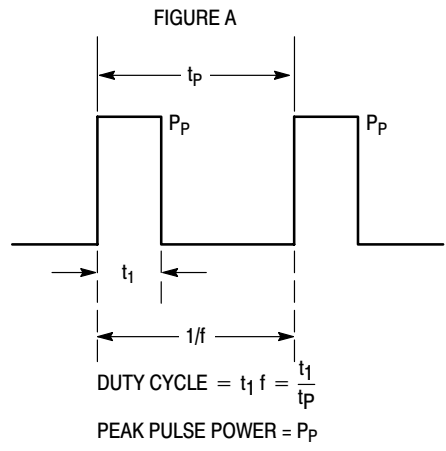

Figure 13. Active Region Safe Operating Area



Design Note: Use of Transient Thermal Resistance Data