

The RF Sub-Micron MOSFET Line
RF Power Field Effect Transistors
N-Channel Enhancement-Mode Lateral MOSFETs

Designed for PCN and PCS base station applications with frequencies from 1.9 to 2.0 GHz. Suitable for TDMA, CDMA and multicarrier amplifier applications.

- Typical 2-Carrier N-CDMA Performance for $V_{DD} = 26$ Volts, $I_{DQ} = 1300$ mA, $f_1 = 1958.75$ MHz, $f_2 = 1961.25$ MHz IS-95 CDMA (Pilot, Sync, Paging, Traffic Codes 8 Through 13) 1.2288 MHz Channel Bandwidth Carrier. Adjacent Channels Measured over a 30 kHz Bandwidth at $f_1 -885$ kHz and $f_2 +885$ kHz. Distortion Products Measured over 1.2288 MHz Bandwidth at $f_1 -2.5$ MHz and $f_2 +2.5$ MHz. Peak/Avg. = 9.8 dB @ 0.01% Probability on CCDF.
Output Power — 24 Watts Avg.
Power Gain — 13.6 dB
Efficiency — 22%
ACPR — -51 dB
IM3 — -37.0 dBc
- Internally Matched, Controlled Q, for Ease of Use
- High Gain, High Efficiency and High Linearity
- Integrated ESD Protection
- Designed for Maximum Gain and Insertion Phase Flatness
- Capable of Handling 5:1 VSWR, @ 26 Vdc, 1990 MHz, 125 Watts (CW) Output Power
- Excellent Thermal Stability
- Characterized with Series Equivalent Large-Signal Impedance Parameters
- Available in Tape and Reel. R3 Suffix = 250 Units per 56 mm, 13 inch Reel.

MRF19125
MRF19125S
MRF19125SR3

1990 MHz, 125 W, 26 V
LATERAL N-CHANNEL
RF POWER MOSFETs

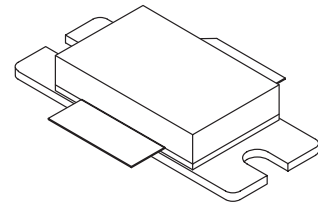

CASE 465B-03, STYLE 1
(NI-880)
(MRF19125)

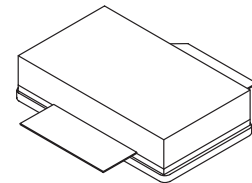

CASE 465C-02, STYLE 1
(NI-880S)
(MRF19125S)

MAXIMUM RATINGS

Rating	Symbol	Value	Unit
Drain-Source Voltage	V_{DSS}	65	Vdc
Gate-Source Voltage	V_{GS}	+15, -0.5	Vdc
Total Device Dissipation @ $T_C = 25^\circ\text{C}$ Derate above 25°C	P_D	330 1.89	Watts W/ $^\circ\text{C}$
Storage Temperature Range	T_{stg}	-65 to +200	$^\circ\text{C}$
Operating Junction Temperature	T_J	200	$^\circ\text{C}$

ESD PROTECTION CHARACTERISTICS

Test Conditions	Class
Human Body Model	2 (Minimum)
Machine Model	M3 (Minimum)

THERMAL CHARACTERISTICS

Characteristic	Symbol	Max	Unit
Thermal Resistance, Junction to Case	$R_{\theta JC}$	0.53	$^\circ\text{C}/\text{W}$

NOTE – CAUTION – MOS devices are susceptible to damage from electrostatic charge. Reasonable precautions in handling and packaging MOS devices should be observed.

ELECTRICAL CHARACTERISTICS ($T_C = 25^\circ\text{C}$ unless otherwise noted)

Characteristic	Symbol	Min	Typ	Max	Unit
OFF CHARACTERISTICS					
Drain–Source Breakdown Voltage ($V_{GS} = 0\text{ Vdc}$, $I_D = 100\ \mu\text{Adc}$)	$V_{(BR)DSS}$	65	—	—	Vdc
Gate–Source Leakage Current ($V_{GS} = 5\text{ Vdc}$, $V_{DS} = 0\text{ Vdc}$)	I_{GSS}	—	—	1	μAdc
Zero Gate Voltage Drain Leakage Current ($V_{DS} = 26\text{ Vdc}$, $V_{GS} = 0\text{ Vdc}$)	I_{DSS}	—	—	10	μAdc

ON CHARACTERISTICS

Forward Transconductance ($V_{DS} = 10\text{ Vdc}$, $I_D = 3\text{ Adc}$)	g_{fs}	—	9	—	S
Gate Threshold Voltage ($V_{DS} = 10\text{ Vdc}$, $I_D = 300\ \mu\text{Adc}$)	$V_{GS(th)}$	2	—	4	Vdc
Gate Quiescent Voltage ($V_{DS} = 26\text{ Vdc}$, $I_D = 1300\text{ mAdc}$)	$V_{GS(Q)}$	2.5	3.9	4.5	Vdc
Drain–Source On–Voltage ($V_{GS} = 10\text{ Vdc}$, $I_D = 3\text{ Adc}$)	$V_{DS(on)}$	—	0.185	0.21	Vdc

DYNAMIC CHARACTERISTICS

Reverse Transfer Capacitance (1) ($V_{DS} = 26\text{ Vdc}$, $V_{GS} = 0$, $f = 1\text{ MHz}$)	C_{rss}	—	5.4	—	pF
--	-----------	---	-----	---	----

FUNCTIONAL TESTS (In Motorola Test Fixture) 2–Carrier N–CDMA, 1.2288 MHz Channel Bandwidth Carriers. Peak/Avg = 9.8 dB @ 0.01% Probability on CCDF.

Common–Source Amplifier Power Gain ($V_{DD} = 26\text{ Vdc}$, $P_{out} = 24\text{ W Avg}$, $I_{DQ} = 1300\text{ mA}$, $f_1 = 1930\text{ MHz}$, $f_2 = 1932.5\text{ MHz}$ and $f_1 = 1987.5\text{ MHz}$, $f_2 = 1990\text{ MHz}$)	G_{ps}	12	13.5	—	dB
Drain Efficiency ($V_{DD} = 26\text{ Vdc}$, $P_{out} = 24\text{ W Avg}$, $I_{DQ} = 1300\text{ mA}$, $f_1 = 1930\text{ MHz}$, $f_2 = 1932.5\text{ MHz}$ and $f_1 = 1987.5\text{ MHz}$, $f_2 = 1990\text{ MHz}$)	η	19	22	—	%
Intermodulation Distortion ($V_{DD} = 26\text{ Vdc}$, $P_{out} = 24\text{ W Avg}$, $I_{DQ} = 1300\text{ mA}$, $f_1 = 1930\text{ MHz}$, $f_2 = 1932.5\text{ MHz}$ and $f_1 = 1987.5\text{ MHz}$, $f_2 = 1990\text{ MHz}$; IM3 measured over 1.2288 MHz Bandwidth at $f_1 - 2.5\text{ MHz}$ and $f_2 + 2.5\text{ MHz}$)	IMD	—	–37	–35	dBc
Adjacent Channel Power Ratio ($V_{DD} = 26\text{ Vdc}$, $P_{out} = 24\text{ W Avg}$, $I_{DQ} = 1300\text{ mA}$, $f_1 = 1930\text{ MHz}$, $f_2 = 1932.5\text{ MHz}$ and $f_1 = 1987.5\text{ MHz}$, $f_2 = 1990\text{ MHz}$; ACPR measured over 30 kHz Bandwidth at $f_1 - 885\text{ MHz}$ and $f_2 + 885\text{ MHz}$)	ACPR	—	–51	–47	dBc
Input Return Loss ($V_{DD} = 26\text{ Vdc}$, $P_{out} = 24\text{ W Avg}$, $I_{DQ} = 1300\text{ mA}$, $f_1 = 1930\text{ MHz}$, $f_2 = 1932.5\text{ MHz}$ and $f_1 = 1987.5\text{ MHz}$, $f_2 = 1990\text{ MHz}$)	IRL	—	–13	–9	dB
Output Mismatch Stress ($V_{DD} = 26\text{ Vdc}$, $P_{out} = 125\text{ W CW}$, $I_{DQ} = 1300\text{ mA}$, $f = 1930\text{ MHz}$, $V_{SWR} = 5:1$, All Phase Angles at Frequency of Test)	Ψ	No Degradation In Output Power Before and After Test			

(1) Part is internally matched both on input and output.

ELECTRICAL CHARACTERISTICS — continued ($T_C = 25^\circ\text{C}$ unless otherwise noted)

Characteristic	Symbol	Min	Typ	Max	Unit
FUNCTIONAL TESTS (In Motorola Test Fixture)					
Two-Tone Common-Source Amplifier Power Gain ($V_{DD} = 26\text{ Vdc}$, $P_{out} = 125\text{ W PEP}$, $I_{DQ} = 1300\text{ mA}$, $f_1 = 1930\text{ MHz}$, $f_2 = 1990\text{ MHz}$, Tone Spacing = 100 kHz)	G_{ps}	—	13.5	—	dB
Two-Tone Drain Efficiency ($V_{DD} = 26\text{ Vdc}$, $P_{out} = 125\text{ W PEP}$, $I_{DQ} = 1300\text{ mA}$, $f_1 = 1930\text{ MHz}$, $f_2 = 1990\text{ MHz}$, Tone Spacing = 100 kHz)	η	—	35	—	%
Third Order Intermodulation Distortion ($V_{DD} = 26\text{ Vdc}$, $P_{out} = 125\text{ W PEP}$, $I_{DQ} = 1300\text{ mA}$, $f_1 = 1930\text{ MHz}$, $f_2 = 1990\text{ MHz}$, Tone Spacing = 100 kHz)	IMD	—	-30	—	dBc
Input Return Loss ($V_{DD} = 26\text{ Vdc}$, $P_{out} = 125\text{ W PEP}$, $I_{DQ} = 1300\text{ mA}$, $f_1 = 1930\text{ MHz}$, $f_2 = 1990\text{ MHz}$, Tone Spacing = 100 kHz)	IRL	—	-13	—	dB
P_{out} : 1 dB Compression Point ($V_{DD} = 26\text{ Vdc}$, $I_{DQ} = 1300\text{ mA}$, $f = 1990\text{ MHz}$)	P1dB	—	130	—	W

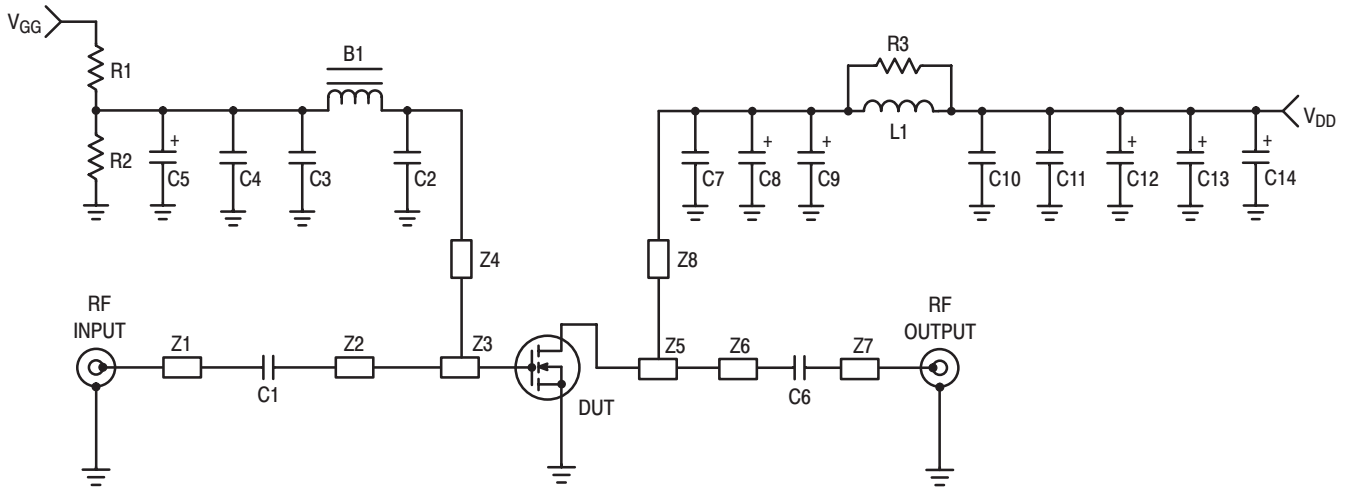

Z1, Z7 0.500" x 0.084" Microstrip
 Z2 1.105" x 0.084" Microstrip
 Z3 0.360" x 0.895" Microstrip
 Z4 0.920" x 0.048" Microstrip
 Z5 0.605" x 1.195" Microstrip
 Z6 0.800" x 0.084" Microstrip
 Z8 0.660" x 0.095" Microstrip

Board 0.030" Glass Teflon[®],
 Keene GX-0300-55-22, $\epsilon_r = 2.55$
 PCB Etched Circuit Boards
 MRF19125 Rev. 5, CMR

Figure 1. MRF19125 Test Circuit Schematic

Table 1. MRF19125 Test Circuit Component Designations and Values

Designators	Description
B1	Short Ferrite Bead, Fair Rite #2743019447
C1	51 pF Chip Capacitor, ATC #100B510JCA500X
C2, C7	5.1 pF Chip Capacitors, ATC #100B5R1JCA500X
C3, C10	1000 pF Chip Capacitors, ATC #100B102JCA500X
C4, C11	0.1 μ F Chip Capacitors, Kemet #CDR33BX104AKWS
C5	0.1 μ F Tantalum Chip Capacitor, Kemet #T491C105M050
C6	10 pF Chip Capacitor, ATC #100B100JCA500X
C8	10 μ F Tantalum Chip Capacitor, Kemet #T491X106K035AS4394
C9, C12, C13, C14	22 μ F Tantalum Chip Capacitors, Kemet #T491X226K035AS4394
L1	1 Turn, #20 AWG, 0.100" ID, Motorola
N1, N2	Type N Flange Mounts, Omni Spectra #3052-1648-10
R1	1.0 k Ω , 1/8 W Chip Resistor
R2	220 k Ω , 1/8 W Chip Resistor
R3	10 Ω , 1/8 W Chip Resistor

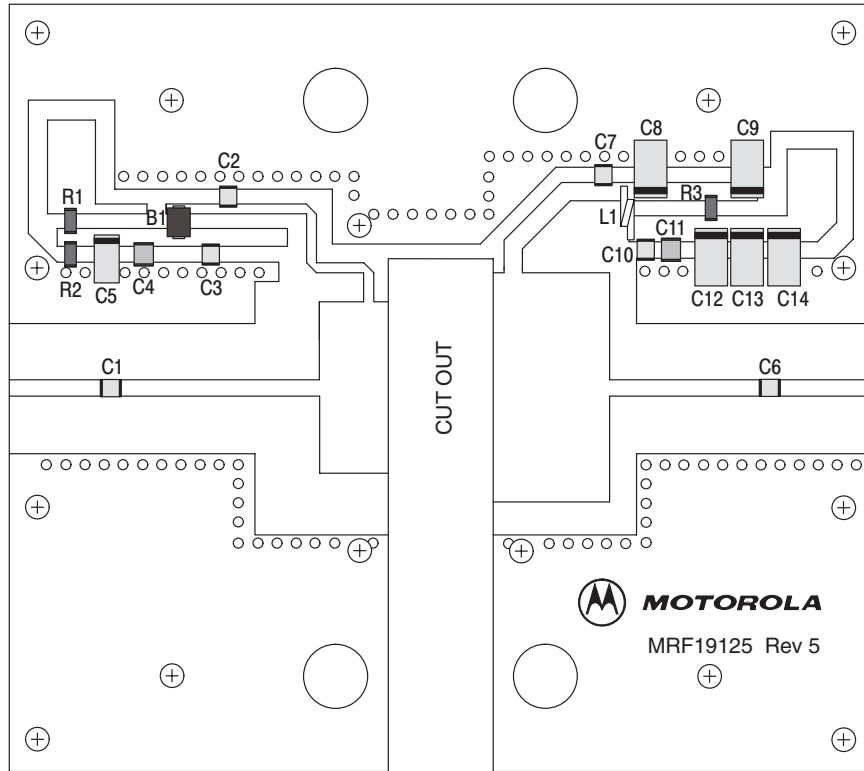

Figure 2. MRF19125 Test Circuit Component Layout

TYPICAL CHARACTERISTICS

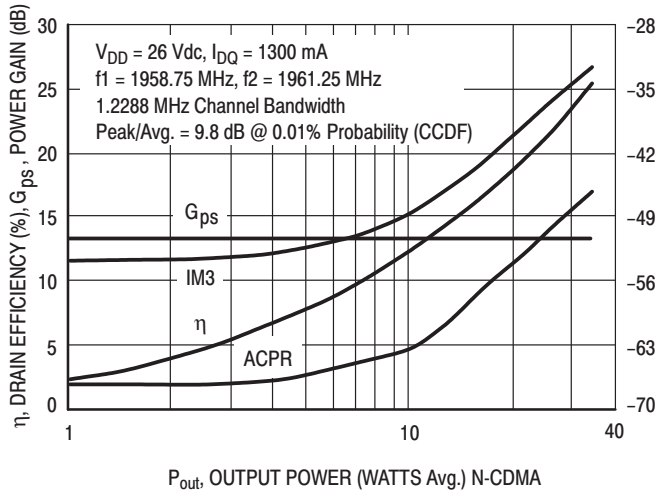

Figure 3. 2-Carrier CDMA ACPR, IM3, Power Gain and Drain Efficiency versus Output Power

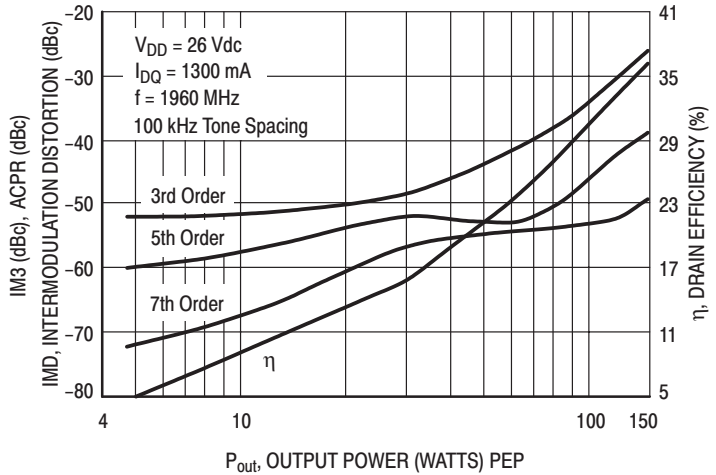

Figure 4. Intermodulation Distortion Products versus Output Power

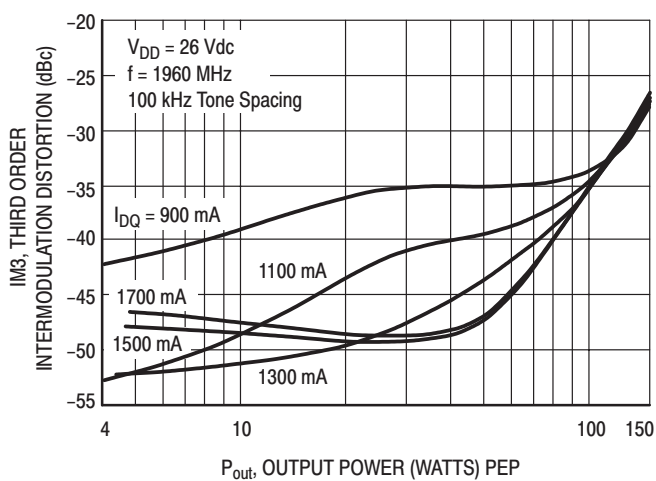

Figure 5. Third Order Intermodulation Distortion versus Output Power

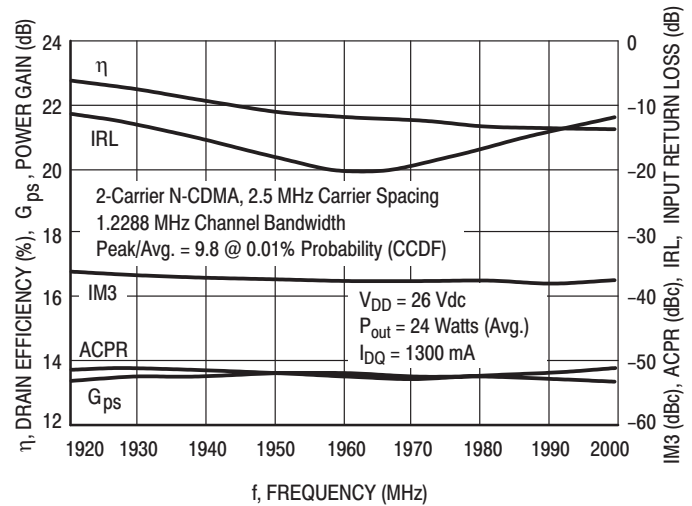

Figure 6. 2-Carrier N-CDMA Broadband Performance

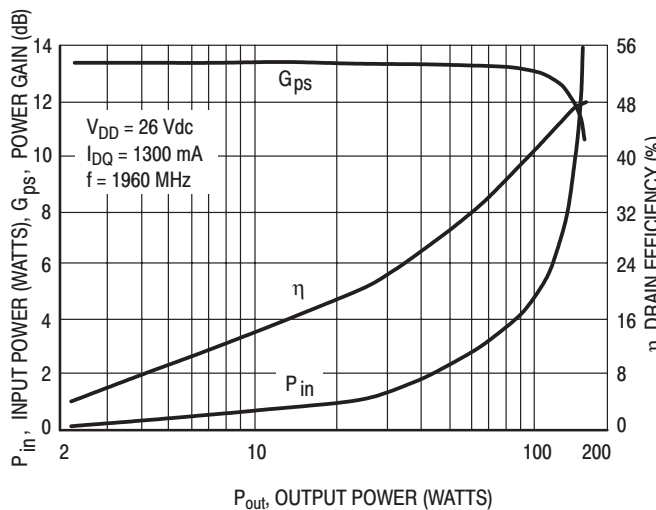

Figure 7. CW Performance

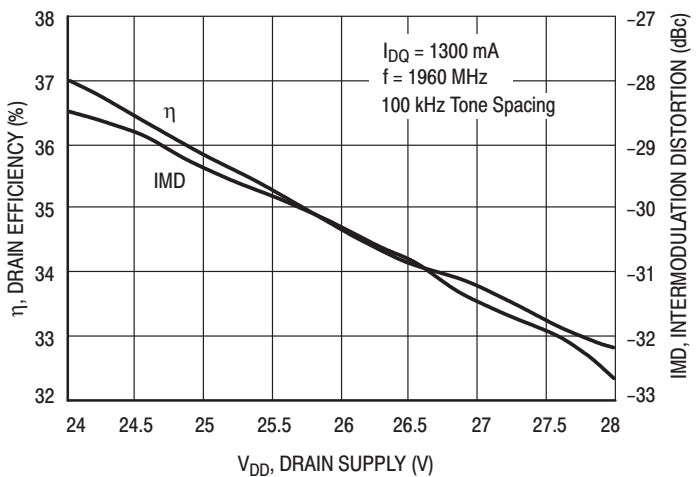

Figure 8. Two-Tone Intermodulation Distortion and Drain Efficiency versus Drain Supply

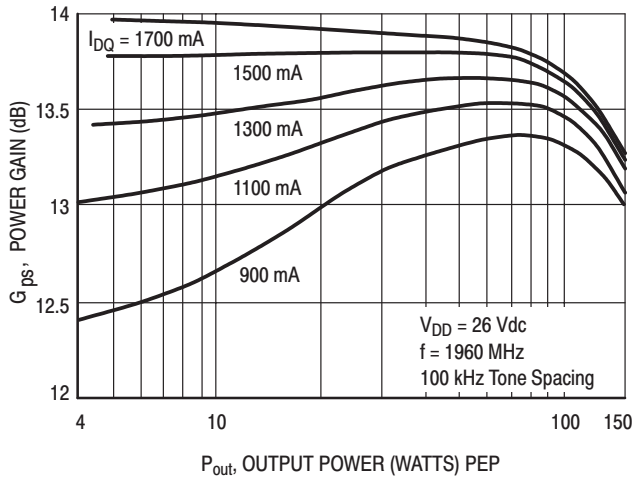

Figure 9. Two-Tone Power Gain versus Output Power

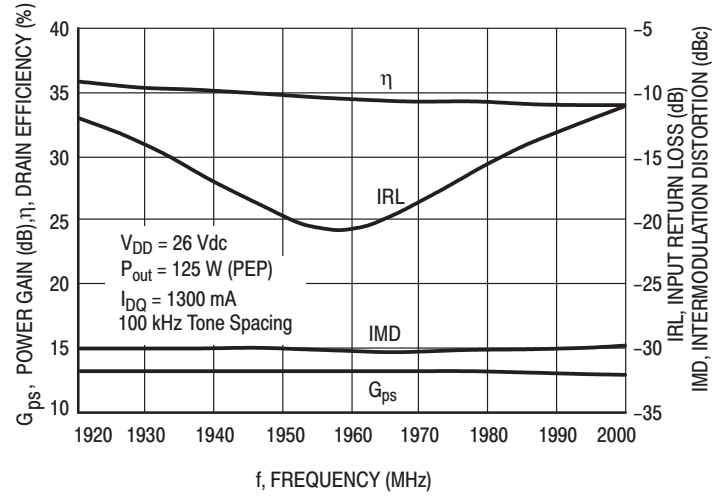

Figure 10. Two-Tone Broadband Performance

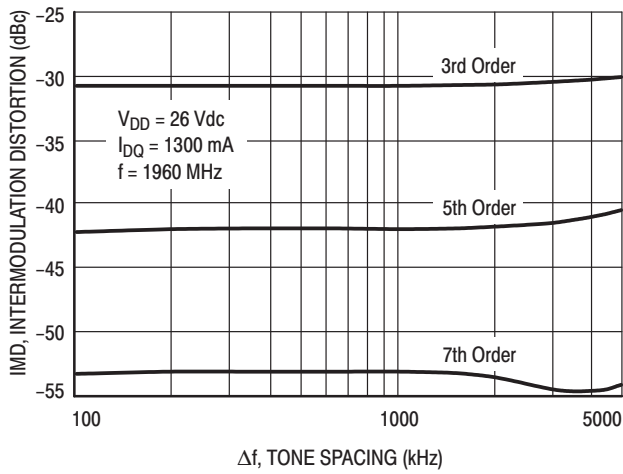

Figure 11. Intermodulation Distortion Products versus Two-Tone Tone Spacing

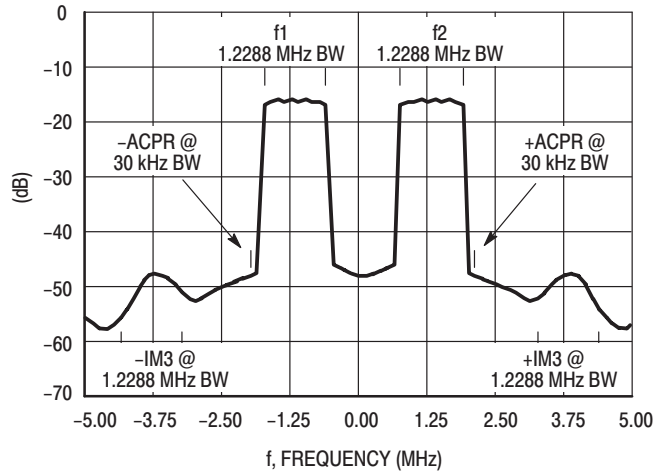
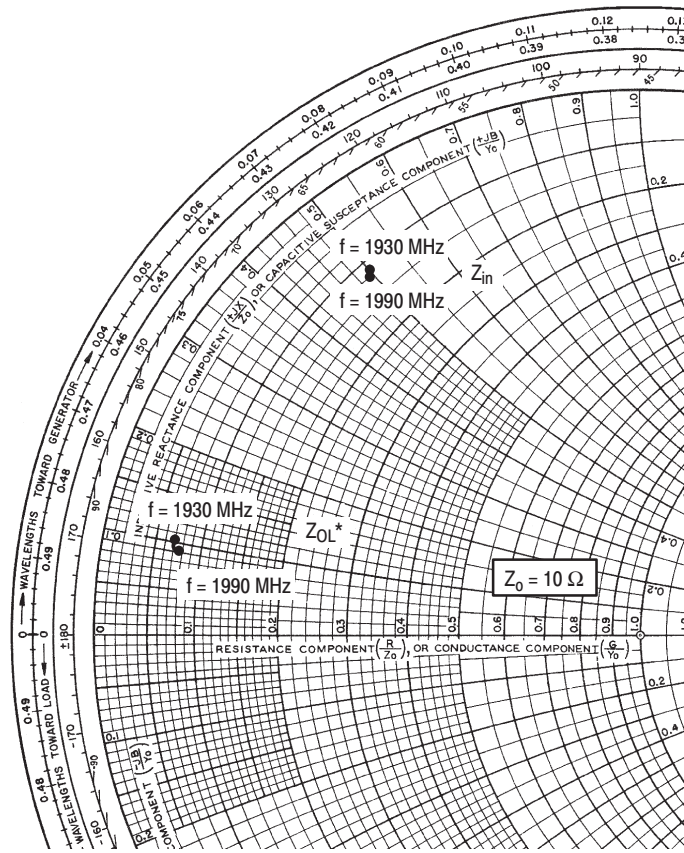

Figure 12. 2-Carrier N-CDMA Spectrum



$V_{DD} = 26 \text{ V}$, $I_{DQ} = 1300 \text{ mA}$, $P_{out} = 24 \text{ W (Avg.)}$

f MHz	Z_{in} Ω	Z_{OL}^* Ω
1930	$1.43 + j5.01$	$0.75 + j0.93$
1960	$1.51 + j4.88$	$0.71 + j0.89$
1990	$1.56 + j4.93$	$0.68 + j1.02$

Z_{in} = Complex conjugate of source impedance.

Z_{OL}^* = Complex conjugate of the optimum load impedance at a given output power, voltage, IMD, bias current and frequency.

Note: Z_{OL}^* was chosen based on tradeoffs between gain, output power, drain efficiency and intermodulation distortion.

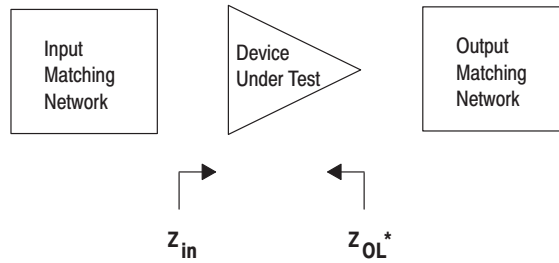
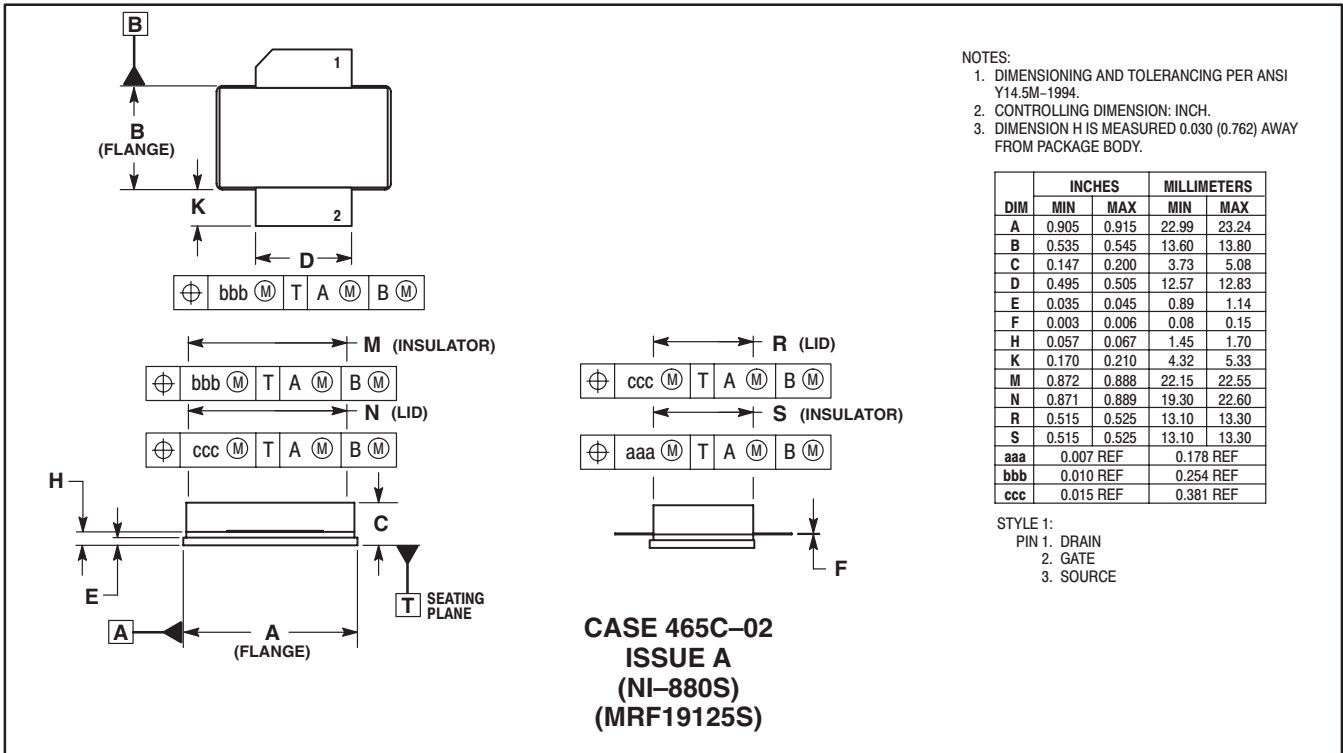
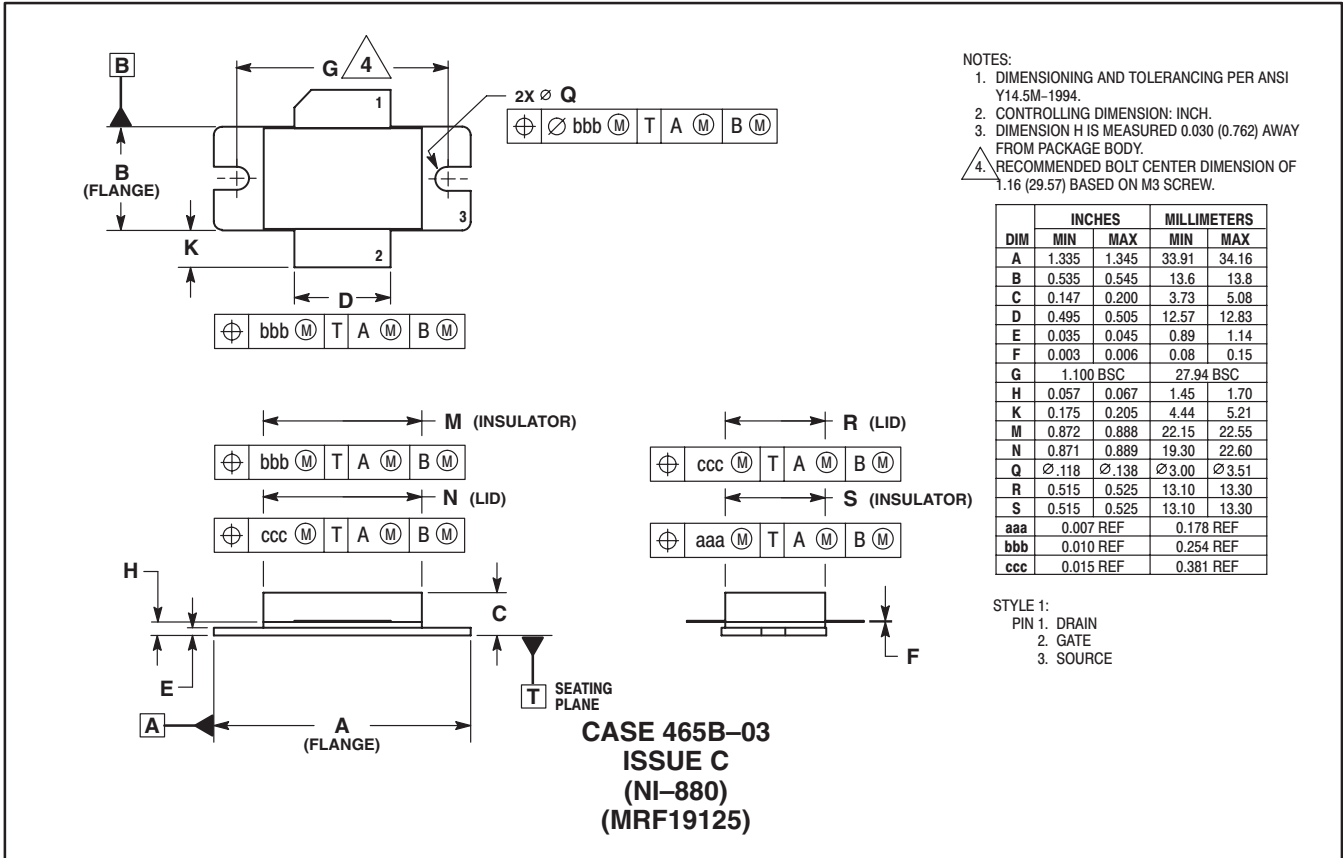



Figure 13. Series Equivalent Input and Output Impedance

NOTES

NOTES

PACKAGE DIMENSIONS



Motorola reserves the right to make changes without further notice to any products herein. Motorola makes no warranty, representation or guarantee regarding the suitability of its products for any particular purpose, nor does Motorola assume any liability arising out of the application or use of any product or circuit, and specifically disclaims any and all liability, including without limitation consequential or incidental damages. "Typical" parameters which may be provided in Motorola data sheets and/or specifications can and do vary in different applications and actual performance may vary over time. All operating parameters, including "Typicals" must be validated for each customer application by customer's technical experts. Motorola does not convey any license under its patent rights nor the rights of others. Motorola products are not designed, intended, or authorized for use as components in systems intended for surgical implant into the body, or other applications intended to support or sustain life, or for any other application in which the failure of the Motorola product could create a situation where personal injury or death may occur. Should Buyer purchase or use Motorola products for any such unintended or unauthorized application, Buyer shall indemnify and hold Motorola and its officers, employees, subsidiaries, affiliates, and distributors harmless against all claims, costs, damages, and expenses, and reasonable attorney fees arising out of, directly or indirectly, any claim of personal injury or death associated with such unintended or unauthorized use, even if such claim alleges that Motorola was negligent regarding the design or manufacture of the part. Motorola, Inc. Motorola, Inc. is an Equal Opportunity/Affirmative Action Employer. MOTOROLA and the  logo are registered in the US Patent & Trademark Office. All other product or service names are the property of their respective owners.

© Motorola, Inc. 2002.

How to reach us:

USA/EUROPE/Locations Not Listed: Motorola Literature Distribution; P.O. Box 5405, Denver, Colorado 80217. 1-303-675-2140 or 1-800-441-2447

JAPAN: Motorola Japan Ltd.; SPS, Technical Information Center, 3-20-1, Minami-Azabu. Minato-ku, Tokyo 106-8573 Japan. 81-3-3440-3569

ASIA/PACIFIC: Motorola Semiconductors H.K. Ltd.; Silicon Harbour Centre, 2 Dai King Street, Tai Po Industrial Estate, Tai Po, N.T., Hong Kong. 852-26668334

Technical Information Center: 1-800-521-6274

HOME PAGE: <http://www.motorola.com/semiconductors/>

