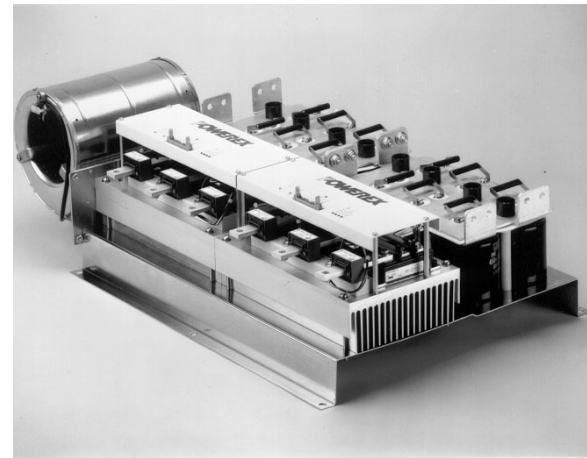

Description:

The Powerex POW-R-PAK™ is a configurable IGBT based power assembly that may be used as a converter, chopper, half or full bridge, or three phase inverter for motor control, power supply, UPS or other power conversion applications.

The power assembly is mounted on a forced air-cooled heatsink and features state-of-the-art Powerex F-series trench gate IGBTs with low conduction and switching losses for high efficiency operation. The POW-R-PAK™ includes a low inductance laminated bus structure, optically isolated gate drive interfaces, isolated gate drive power supplies, and a DC-link capacitor bank. The control board provides a simple user interface along with built-in protection features including overvoltage, undervoltage lockout, overcurrent, overtemperature, and short circuit detection.

Depending on application characteristics the POW-R-PAK™ is suitable for operation with DC bus voltages up to 800VDC and switching frequencies above 20kHz.

Schematic**Features:**

- High performance IGBT inverter bridge
- Integrated gate drive with fault monitoring & protection
- System status / troubleshooting LEDs to verify or monitor proper operation
- Isolated gate drive power supplies
- Low inductance laminated bus
- Output current measurement & feedback
- Superior short circuit detection & shoot through prevention

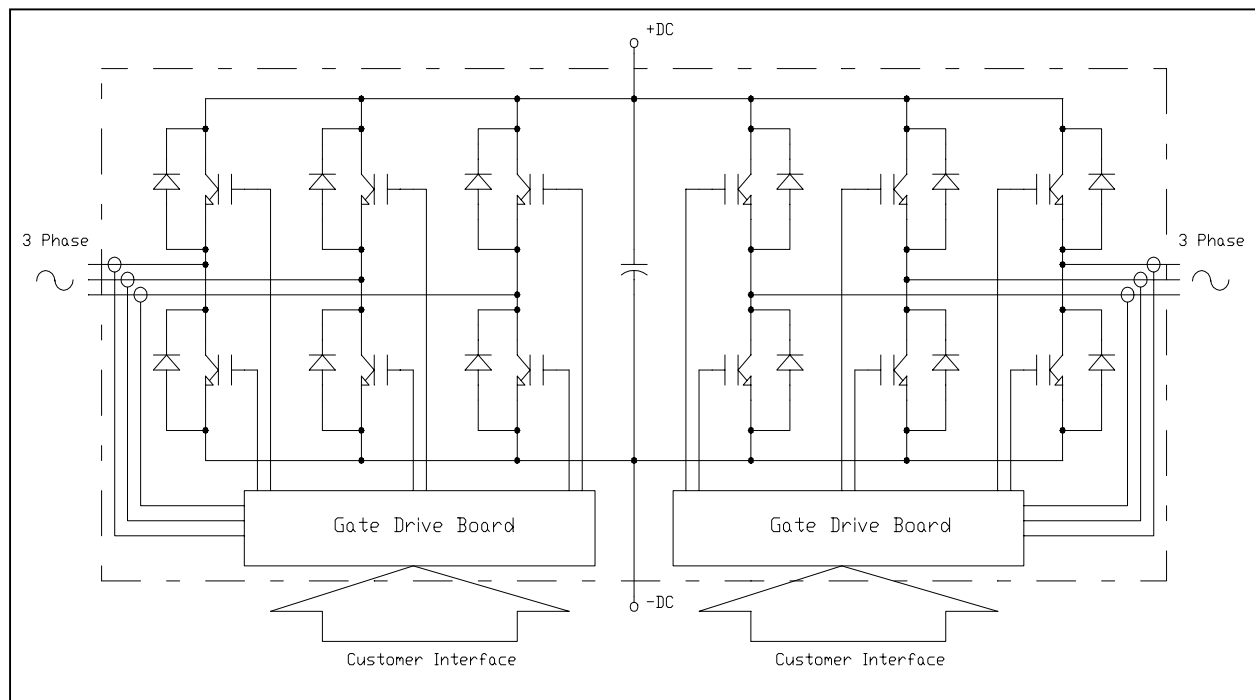

Absolute Maximum Ratings, $T_j = 25^\circ\text{C}$ unless otherwise specified

| General | Symbol | | Units |
|---|-----------|-------------|------------------|
| IGBT Junction Temperature | T_j | -40 to +150 | $^\circ\text{C}$ |
| Storage Temperature | T_{stg} | -40 to +125 | $^\circ\text{C}$ |
| Operating Temperature | T_{op} | -25 to +85 | $^\circ\text{C}$ |
| Voltage Applied to DC terminals | V_{CC} | 800 | Volts |
| Isolation Voltage, AC 1 minute, 60Hz sinusoidal | V_{iso} | 2500 | Volts |
| IGBT Inverter | | | |
| Collector Current ($T_c = 25^\circ\text{C}$) | I_C | 150 | Amperes |
| Peak Collector Current ($T_j < 150^\circ\text{C}$) | I_{CM} | 300 | Amperes |
| Emitter Current | I_E | 150 | Amperes |
| Peak Emitter Current | I_{EM} | 300 | Amperes |
| Maximum Collector Dissipation ($T_j < 150^\circ\text{C}$) | P_c | 520 | Watts |
| Gate Drive Board | | | |
| Unregulated +24V Power Supply | | 30 | Volts |
| Regulated +15V Power Supply | | 18 | Volts |
| PWM Signal Input Voltage | | 20 | Volts |
| Fault Output Supply Voltage | | 30 | Volts |
| Fault Output Current | | 50 | mA |

IGBT Inverter Electrical Characteristics, $T_j = 25^\circ\text{C}$ unless otherwise specified

| Characteristics | Symbol | Test Conditions | Min | Typ | Max | Units |
|--|---------------|--|-----|------|-----|---------------|
| Collector Cutoff Current | I_{CES} | $V_{CE} = V_{CES}, V_{GE} = 0V$ | - | - | 1 | mA |
| Collector – Emitter Saturation Voltage | $V_{CE(sat)}$ | $I_C = 150A, T_j = 25^\circ\text{C}$ | - | 1.8 | 2.4 | Volts |
| | | $I_C = 150A, T_j = 125^\circ\text{C}$ | - | 1.9 | - | Volts |
| Emitter – Collector Voltage | V_{EC} | $I_E = 150A$ | - | - | 3.2 | Volts |
| Inductive Load Switching Times | $t_{d(on)}$ | $V_{CC} = 600V$ $I_C = 150A$ $V_{GE} = 15V$ $R_G = 2.1\Omega$ | - | - | 150 | ns |
| | t_r | | - | - | 80 | ns |
| | $t_{d(off)}$ | | - | - | 450 | ns |
| | t_f | | - | - | 300 | ns |
| Diode Reverse Recovery Time | t_{rr} | | - | - | 150 | ns |
| Diode Reverse Recovery Charge | Q_{rr} | | - | 6.0 | - | μC |
| DC Link Capacitance | | | | 6600 | | μF |

Gate Drive Board Electrical Characteristics

| Characteristics | Min | Typ | Max | Units |
|-------------------------------|------------------|-----|-----|---------|
| Unregulated +24V Power Supply | 20 | 24 | 30 | Volts |
| Regulated +15V Power Supply | 14.4 | 15 | 18 | Volts |
| PWM Input On Threshold | 12 | 15 | | Volts |
| PWM Input Off Threshold | | 0 | 2 | Volts |
| Output Overcurrent Trip | | 225 | | Amperes |
| Overtemperature Trip | 96 | 98 | 100 | °C |
| Overvoltage Trip | | 920 | | Volts |
| DC Link Voltage Feedback | See Figure Below | | | Volts |
| Heatsink Temperature Feedback | See Figure Below | | | Volts |
| Output Current Feedback | See Figure Below | | | Volts |

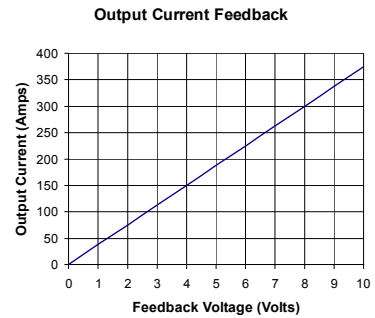
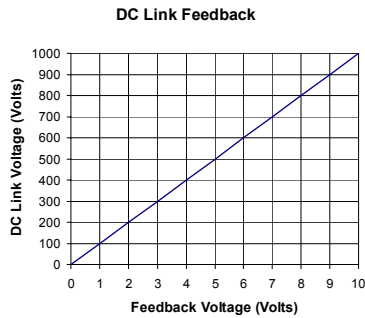

Thermal and Mechanical Characteristics

| Characteristics | Symbol | Test Conditions | Min | Typ | Max | Units |
|---|----------------|-------------------|-----|-------|------|-------|
| IGBT Thermal Resistance, Junction to Case | $R_{th(j-c)Q}$ | Per IGBT ½ module | - | 0.11 | 0.21 | °C/W |
| FWD Thermal Resistance, Junction to Case | $R_{th(j-c)D}$ | Per FWD ½ module | | | 0.24 | °C/W |
| Contact Thermal Resistance | $R_{th(c-f)}$ | | - | 0.020 | - | °C/W |
| Heatsink Thermal Resistance | $R_{th(f-a)}$ | 1000 LFM airflow | | 0.04 | | °C/W |
| Mounting Torque, AC terminals | | | | 75 | 90 | in-lb |
| Mounting Torque, DC terminals | | | | 130 | 150 | in-lb |
| Mounting Torque, Mounting plate | | | | 130 | 150 | in-lb |
| Weight | | | | 21 | | lb |

Gate Drive Board Interface Signal Definitions

| Pin | Signal Name | Description |
|-----|---------------------------------|--|
| 1 | Shield | Connected to circuit ground |
| 2 | PWM A- | 0-15 V signal controlling the duty cycle of A- IGBT |
| 3 | Phase A Error ¹ | Open collector output, external pull-up resistor required LOW = No Error; Floating = Phase A overcurrent or short circuit |
| 4 | PWM A+ | 0-15 V signal controlling the duty cycle of A+ IGBT |
| 5 | PWM B- | 0-15 V signal controlling the duty cycle of B- IGBT |
| 6 | Phase B Error ¹ | Open collector output, external pull-up resistor required LOW = No Error; Floating = Phase B overcurrent or short circuit |
| 7 | PWM B+ | 0-15 V signal controlling the duty cycle of B+ IGBT |
| 8 | PWM C- | 0-15 V signal controlling the duty cycle of C- IGBT |
| 9 | Phase C Error ¹ | Open collector output, external pull-up resistor required LOW = No Error; Floating = Phase C overcurrent or short circuit |
| 10 | PWM C+ | 0-15 V signal controlling the duty cycle of C+ IGBT |
| 11 | Overtemp ¹ | Open collector output, external pull-up resistor required LOW = No Error; Floating = heatsink overtemp |
| 12 | Not Connected | |
| 13 | DC Link Voltage | Analog voltage representation of DC link voltage |
| 14 | 24 VDC input power ² | 20 – 30 VDC input voltage range |
| 15 | 24 VDC input power ² | 20 – 30 VDC input voltage range |
| 16 | 15 VDC input power ² | 14.4 – 18 VDC input voltage range |
| 17 | 15 VDC input power ² | 14.4 – 18 VDC input voltage range |
| 18 | GND | Ground reference for 15 and 24 VDC inputs |
| 19 | GND | Ground reference for 15 and 24 VDC inputs |
| 20 | Heatsink Temperature | Analog voltage representation of heatsink temperature |
| 21 | GND ³ | Tied to pins 18 and 19 |
| 22 | I _{out} Phase A | Analog voltage representation of phase A output current |
| 23 | GND ³ | Tied to pins 18 and 19 |
| 24 | I _{out} Phase B | Analog voltage representation of phase B output current |
| 25 | GND ³ | Tied to pins 18 and 19 |
| 26 | I _{out} Phase C | Analog voltage representation of phase C output current |

Notes:

1. Open collectors can be pulled up to 30 V max and sink 50mA continuous.
2. Do not connect a 15 VDC and 24 VDC source to the unit at the same time, use one or the other.
3. GND signals to be used for analog feedback signals, i.e. twisted pair with I_{out} Phase A.

Gate Drive Board Interface Connector

| Description | Symbol | Type | Manufacturer |
|-----------------------------------|--------|---|-----------------------------|
| Gate Drive Board Interface Header | J1 | 0.100" x 0.100" latching header, 26 pin | 3M# 3429-6002 or equivalent |
| Recommended Mating Socket | - | 0.100" x 0.100" IDC socket, 26 pin | 3M# 3399-7600 or equivalent |
| Recommended Strain Relief | - | Plastic strain relief | 3M# 3448-3026 or equivalent |

Performance Curves

Effective Output Current vs. Carrier Frequency (Typical)

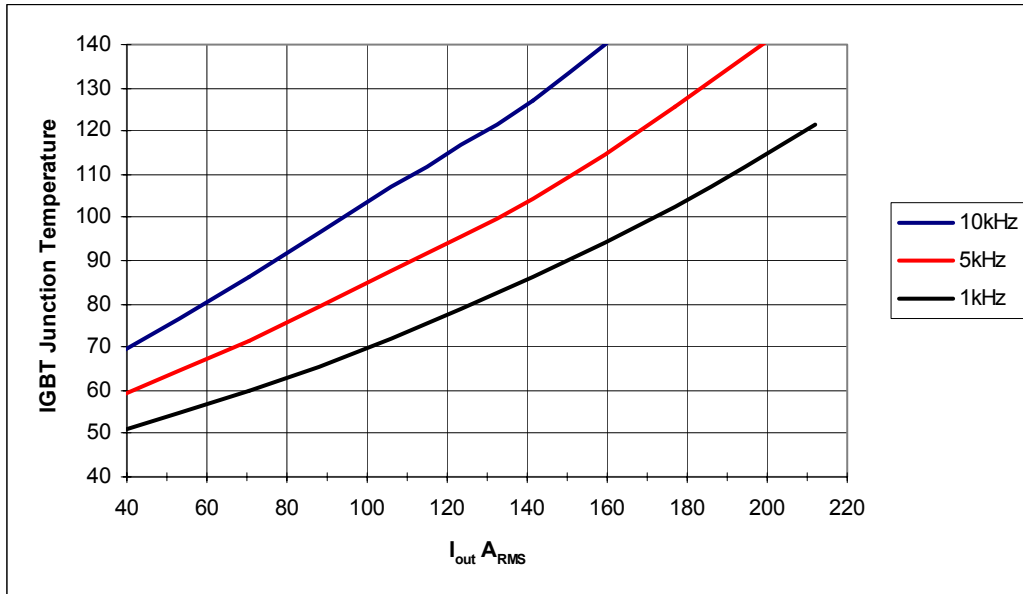

| Condition | Symbol | Value | Units |
|-------------------------|-------------------------------------|-------------------------------------|-------|
| Ambient Temperature | T_A | 40 | °C |
| DC Bus Voltage | V_{CC} | 600 | Volts |
| Load Power Factor | $\cos \phi$ | 0.8 | |
| IGBT Saturation Voltage | $V_{CE(sat)}$ | Typical @ $T_J = 125^\circ\text{C}$ | Volts |
| IGBT Switching Loss | E_{SW} | Typical @ $T_J = 125^\circ\text{C}$ | mJ |
| Airflow | - | 1500 | LFM |
| Switching Conditions | 3 phase PWM, 60Hz sinusoidal output | | |

Mechanical Drawing

