

**Silicon Doubled Balanced HMIC Mixer
1700 – 2500 MHz**

**MAMX-000240-1225MT
V1**

Features

- Low Cost Miniature Plastic Package
- 5.5 dB Typical Conversion Loss at 2100 MHz
- 6.7 dB Typical Conversion Loss at 2500 MHz
- +7 to +13 dBm LO Drive
- HMIC™ Process
- Silicon Medium Barrier Schottky Diodes
- DC - 500 MHz IF Bandwidth
- Lead Free (RoHS Compliant) with 260 °C Reflow Capability
- 100% Matte Tin Plating

Description and Applications

M/A-COM's MAMX-000240-1225MT is a silicon monolithic 1700-2500 MHz double balanced mixer in a low cost miniature surface mount SOT-25 package. The die uses M/A-COM's unique HMIC™ silicon/glass process to achieve low loss passive elements while retaining the advantages of medium barrier silicon Schottky diodes.

These mixers are well suited for high volume WLAN and cellular applications where small size and repeatability are required. Typical applications include frequency conversion, modulation, and demodulation for receivers and transmitters in both portable cellular and base station applications.

Package Outline

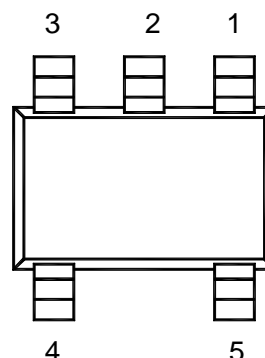

PIN Configuration

PIN	Function	PIN	Function
1	GND	4	RF
2	GND	5	LO
3	IF		

Absolute Maximum Ratings¹

Parameter	Maximum Ratings
Operating Temperature	-40 °C to +85 °C
Storage Temperature	-65 °C to +150 °C
Incident LO Power	+20 dBm
Incident RF Power	+20 dBm
Soldering Temperature	+260 °C max.

1. Exceeding these limits may cause permanent damage.

Functional Schematic

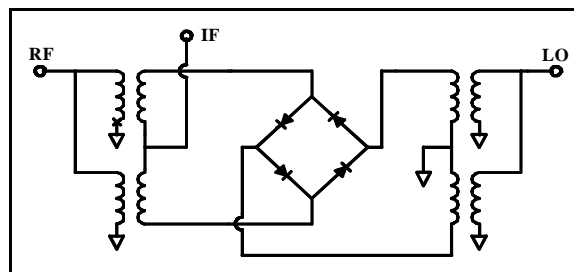

**Silicon Doubled Balanced HMIC Mixer
1700 – 2500 MHz**

**MAMX-000240-1225MT
V1**

Electrical Specifications @ +25 °C

Parameter	Frequency Range	Test Conditions	Units	Min.	Typ.	Max.
Conversion Loss	2100 MHz 1700-2500 MHz	LO Drive = +10 dBm RF = -10 dBm, IF = 60 MHz	dB dB		5.5 6.2	6.0 7.5
L - R Isolation	2100 MHz 1700-2500 MHz	LO Drive = +10 dBm RF Level = -10 dBm	dB dB		17.0 16.0	
L - I Isolation	2100 MHz 1700-2500 MHz	LO Drive = +10 dBm RF Level = -10 dBm	dB dB		22.0 22.0	
R - I Isolation	2100 MHz 1700-2500 MHz	LO Drive = +10 dBm RF Level = -10 dBm	dB dB		12.0 13.0	
LO VSWR	2100 MHz 1700-2500 MHz	LO Drive = +10 dBm			2.3:1 2.5:1	
RF VSWR	2100 MHz 1700-2500 MHz	LO Drive = +10 dBm RF Level = -10 dBm			1.2:1 1.7:1	
IF VSWR	DC - 400 MHz	LO Drive = +10 dBm RF Level = -10 dBm			1.6:1	
Input IP3	2100 MHz 1700-2500 MHz	LO Drive = +10 dBm IF = 60 MHz	dBm dBm	16.0 12.0	18.0 15.5	
Input 1 dB Compression	2100 MHz 1700-2500 MHz	LO Drive = +10 dBm IF = 60 MHz	dBm dBm		5.3 6.0	
IF 1 dB Bandwidth			MHz	0		500.0

**Silicon Doubled Balanced HMIC Mixer
1700 – 2500 MHz**

**MAMX-000240-1225MT
V1**

Typical Performance Curves (LO Drive = +10 dBm, RF = -10 dBm, IF = 60 MHz)

Conversion Loss

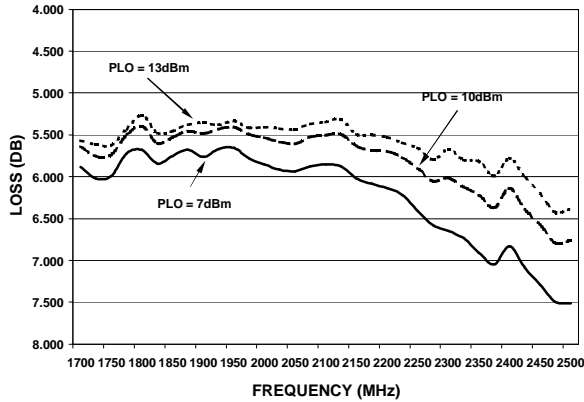

Isolation

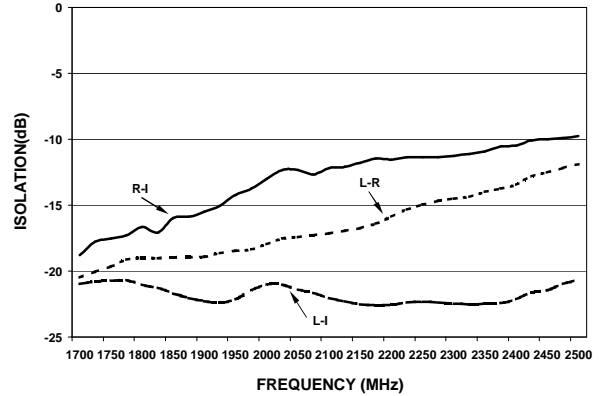

VSWR

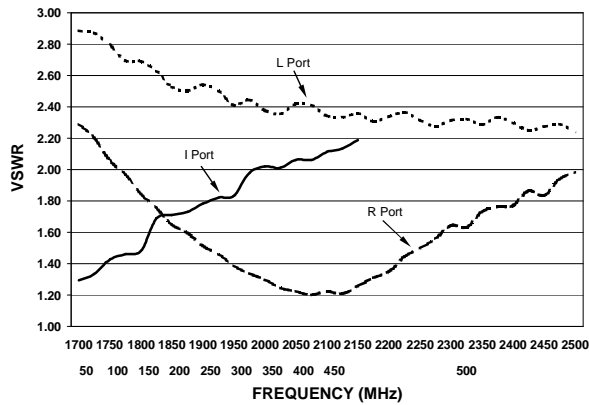

Input IP3 & 1 dB Compression Point

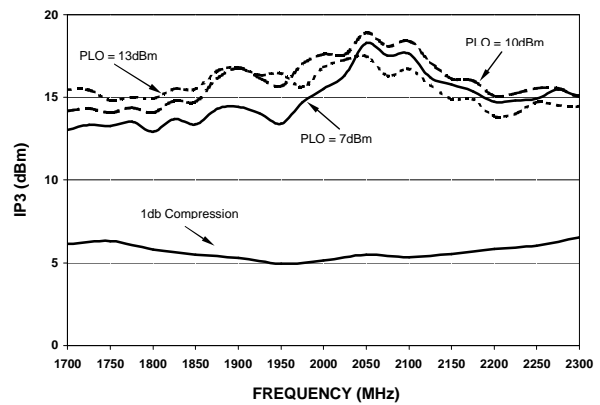

**Silicon Doubled Balanced HMIC Mixer
1700 – 2500 MHz**

**MAMX-000240-1225MT
V1**

Case Style - SOT-25

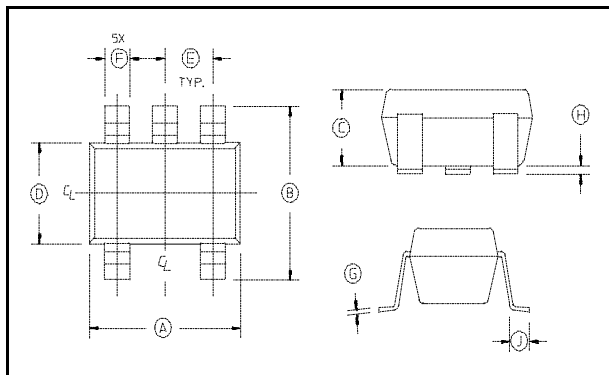

SOT-25 Dimensions

Dim	Inches		Millimeters	
	Min.	Max.	Min.	Max.
A	.106	.122	2.70	3.10
B	.100	.118	2.54	3.00
C	—	.051	—	1.30
D	.063 REF.		1.60 REF.	
E	.032	.043	.80	1.10
F	.014	.020	.35	.50
G	.003	—	.08	—
H	.000	.006	.00	.15
J	.018 REF.		.45 REF.	

Notes: 1. Leads Coplanarity should be 0.003 (0.08) max.

Ordering Information

Part Number	Package
MAMX-000240-1225MT	Tape and Reel