



SensComp, Inc.
36704 Commerce Rd.
Livonia, MI 48150
Telephone: (734) 953-4783
Fax: (734) 953-4518
www.senscomp.com

Digital Chip TL851

SensComp Electronic Component – TL851 Digital Integrated Circuit

Features

Economical Ranging Control when used with Analog IC
PID# 614906 (through-hole) or PID# 629409 (SMT).
Operates With Single Supply Voltage.
Measurement Control Range from 6 inches to 35 feet.
Multiple Target Detection
Interfaces to Electrostatic and Piezoelectric Transducers.
Synchronous 4-bit Gain Control Output(12 steps).
Internal 1.2 volt Level Detector.
Accurate Clock Output For External Use.
TTL Compatible.

Part No.

PID# 614903 – Digital IC TL851 – 16 pin SOIC (SMT) package
PID# 614904 – Digital IC TL851 – 16 pin N (thru-hole) package

Description

Specifications

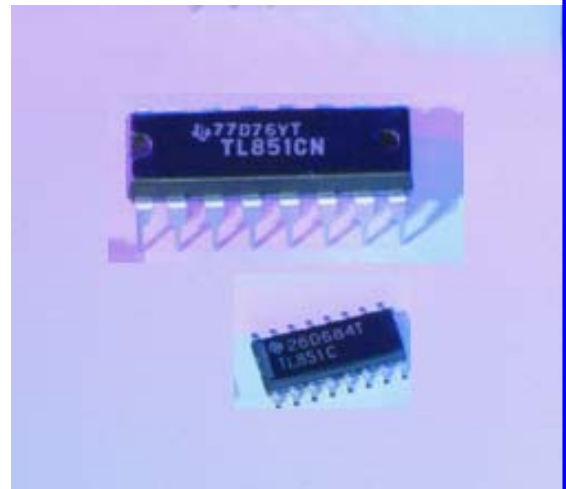

The TL851 is an economical digital I2L ranging control integrated circuit designed for use with the SensComp 614906 sonar ranging receiver integrated circuit. The TL851 is designed for distance measurement from 6 inches to 35 feet. The device has an internal oscillator that uses a low-cost external ceramic resonator. With a simple interface and a 420 kHz ceramic resonator, the device will drive a 50 kHz electrostatic transducer.

The device cycle begins when initiate (INIT) is taken to the high logic level. There must be at least 5 ms from initial power up (Vcc) to the first initiate signal in order for all the device internal latches to reset and for the ceramic resonator controlled oscillator to stabilize. The device will transmit a burst of 16 pulses each time INIT is taken high.

The oscillator output (OSC) is enabled by INIT. The oscillator frequency is the ceramic resonator frequency divided by 8.5 for the first 16 cycles (during transmit) and then the oscillator frequency changes to the ceramic resonator frequency divided by 4.5 for the remainder of the device cycle.

When used with an external 420 kHz ceramic resonator, the device internal blanking disables the receive input (REC) for 2.38 ms after initiate to exclude false receive inputs that may be caused by transducer ringing. The internal blanking feature also eliminates echoes from objects closer than 1.3 ft. from the transducer. If it is necessary to detect objects closer than 1.3 feet then the internal blanking may be shortened by taking the blanking inhibit (BINH) high, enabling the receive input. The blanking input (BLNK) may be used to disable the receive input and reset ECHO to a low logic level at any time during the device cycle for selective echo exclusion or for a multiple-echo mode of operation.

The device provides a synchronous 4-bit gain control output (12 steps) designed to control the gain of the TL852 sonar ranging receiver integrated circuit. The digital gain control waveforms are shown on page 4, with the nominal transition times from INIT listed in the Gain Control Output Table on page 3. The threshold of the internal receive level detector is 1.2 volts. The TL851 operates over a supply voltage range of 4.5 volts to 6.8 volts (+5 volts DC nominal voltage) and is characterized for operation from 0°C to 40°C.

For more information, visit our website: www.senscomp.com

Copyright © 2004 SensComp, Inc. 4/28/04

Absolute Maximum Ratings over Operating Free-Air Temperature Range

Voltage at any pin with respect to ground.....	-0.5 to +7.0 VDC
Voltage at any pin with respect to V_{CC}	-7.0 to +0.5 VDC
Continuous power dissipation at (or below) 25° C free-air temperature (see note).....	1150 mW
Operating free-air temperature range	0° C to 70° C
Storage temperature range	-65° C to 150° C
Lead temperature 1.6 mm (1/16 inch) from case for 10 seconds.....	260° C

Note: For operation above 25° C, derate linearly at the rate of 9.2 mW/C

Recommended Operating Conditions

	MIN	MAX	UNIT
Supply Voltage, V_{CC}	4.5	6.8	V
High-level Input Voltage, V_{IH}	2.1		V
Low-level Input Voltage, V_{IL}		0.6	V
ECHO and OSC Output Voltage		6.8	V
Delay Time, Power Up to INIT High	5		ms
Operating Free-air Temperature	0	40	°C

Electrical Characteristics over Recommended Ranges of Supply Voltage and Operating Free-Air Temperature (typical values at $V_{CC} = 5VDC$ and $T_A = 25° C$)

PARAMETER	TEST COND.	MIN	TYP	MAX	UNIT
Input Current	BLNK, BINH, INIT $V_I = 2.1 V$			1	mA
High-level Output Current, I_{OH}	ECHO, OSC, GC* $V_{OH} = 5.5V$			100	μA
Low-level Output Voltage, V_{OL}	ECHO, OSC, GC* $I_{OL} = 1.6 mA$			0.4	V
On-state Output Current	XMIT output $V_O = 1V$		-140		mA
Internal Blanking Interval			2.38†		ms
Frequency During 16-pulse	OSC output		49.4†		kHz
Transmit Period	XMIT output		49.4†		kHz
Frequency After 16-pulse	OSC output		93.3†		kHz
Transmit Period	XMIT output		0		kHz
Supply Current, I_{CC}	During transmit period			260	mA
	After transmit period			55	mA

† These typical values apply for a 420 kHz ceramic resonator

Pinout Description

Pin	Name	Description	Pin	Name	Description
1	V_{CC}	Positive Supply	16	BLNK	Blanking
2	XMIT	Transmit	15	BINH	Blanking Inhibit
3	GND	Circuit Ground	14	INIT	Ranging Initiate
4	GCD	MSB Digital Gain Control	13	FIL	V_{CC} Filter
5	GCA	LSB Digital Gain Control	12	XTAL1	Crystal Input
6	GCB	Digital Gain Control	11	XTAL2	Crystal Input
7	GCC	Digital Gain Control	10	OSC	Oscillator Clock Output
8	REC	Receive Input (analog level)	9	ECHO	Echo Detected (digital level)

**N PACKAGE
(TOP VIEW)**

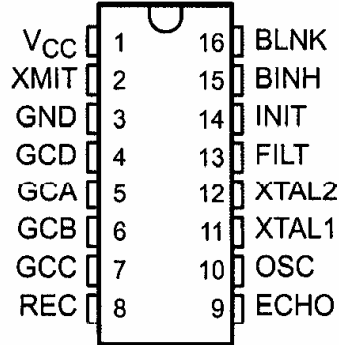

**SOIC PACKAGE
(Top View)**

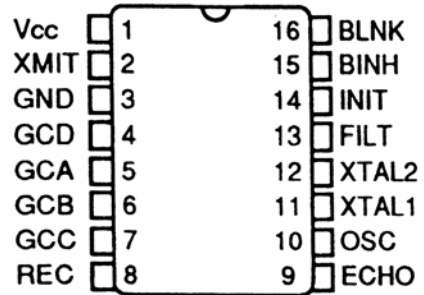

GAIN CONTROL OUTPUT TABLE

STEP NUMBER	GCD	GCC	GCB	GCA	TIME (ms) FROM INITIATE*
0	L	L	L	L	2.38 ms
1	L	L	L	H	5.12 ms
2	L	L	H	L	7.87 ms
3	L	L	H	H	10.61 ms
4	L	H	L	L	13.35 ms
5	L	H	L	H	16.09 ms
6	L	H	H	L	18.84 ms
7	L	H	H	H	21.58 ms
8	H	L	L	L	27.07 ms
9	H	L	L	H	32.55 ms
10	H	L	H	L	38.04 ms
11	H	L	H	H	INIT↓

*This is the time to the end of the indicated step and assumes a nominal 420 kHz ceramic resonator.

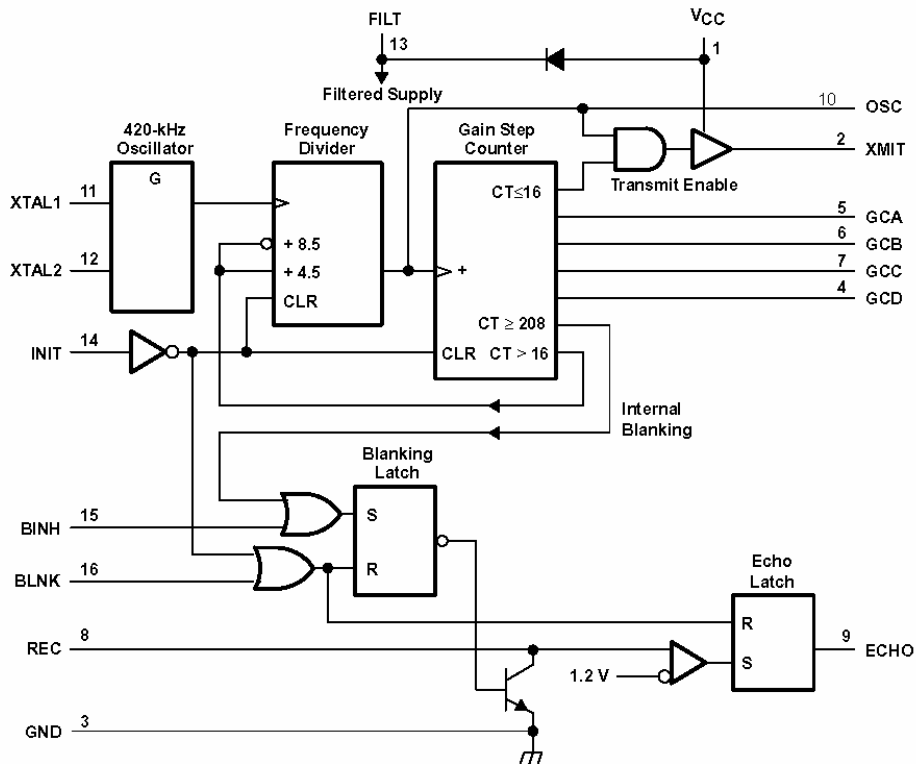

FUNCTIONAL BLOCK DIAGRAM

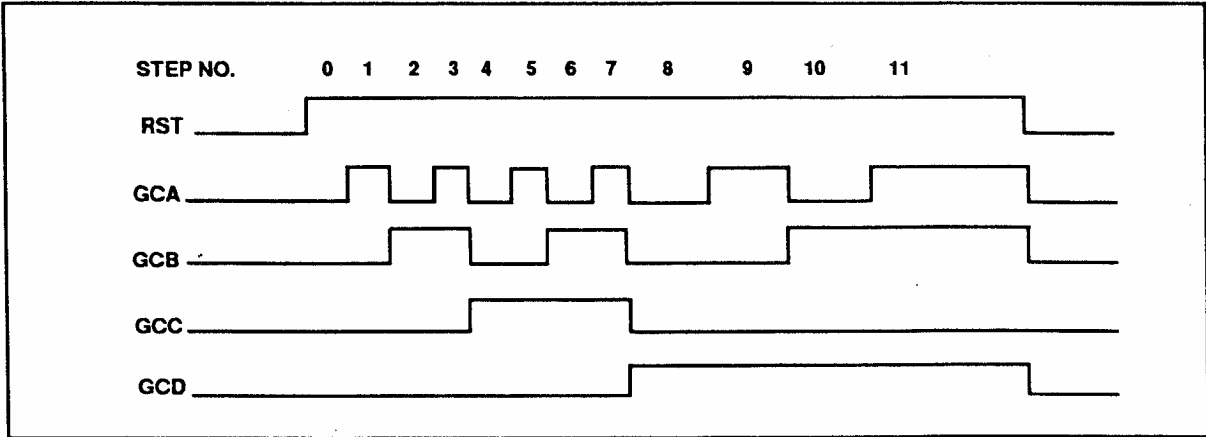

Digital Gain Control Waveforms

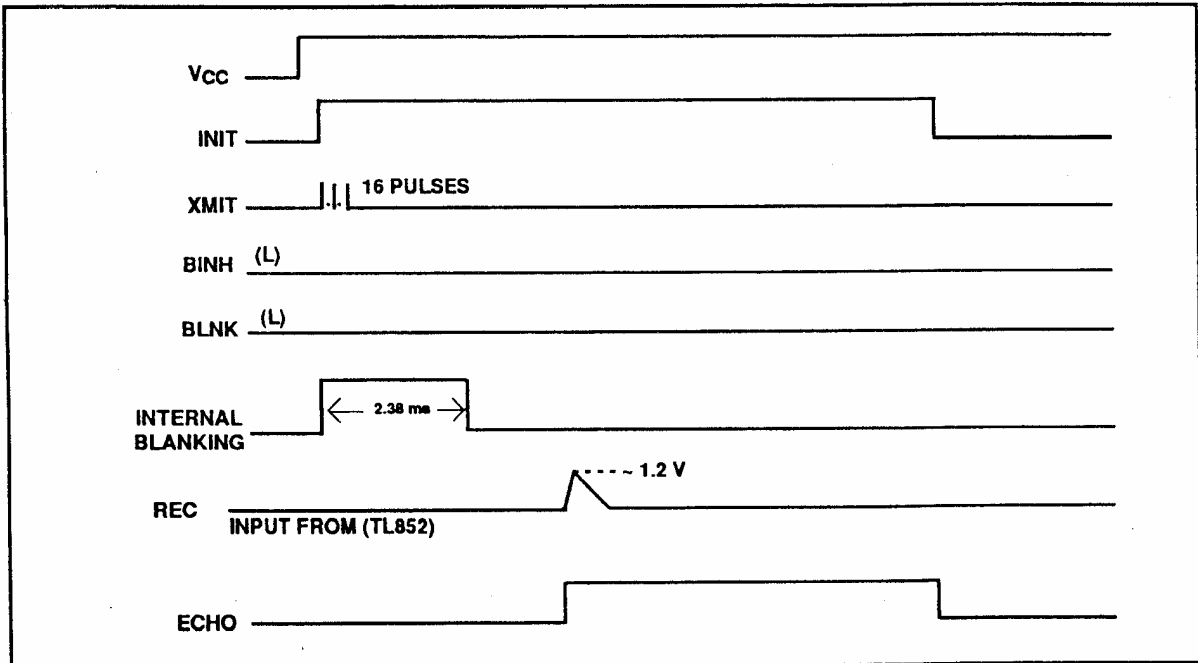

Example of a Single-Echo-Mode Cycle when used with the TL852 Receiver and 420 kHz Ceramic Resonator

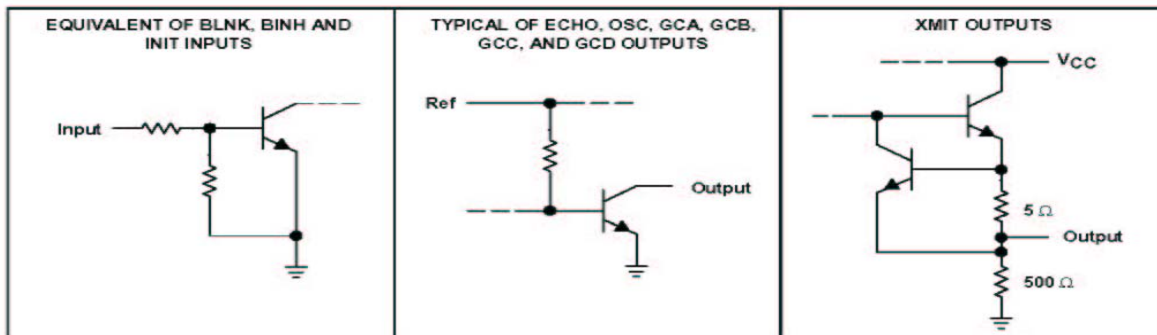

Typical Inputs and Outputs