

## Features

- Low Turn-on Voltage
- Fast Switching
- PN Junction Guard Ring for Transient and ESD Protection
- Designed for Surface Mount Application
- Plastic Material – UL Recognition Flammability Classification 94V-O

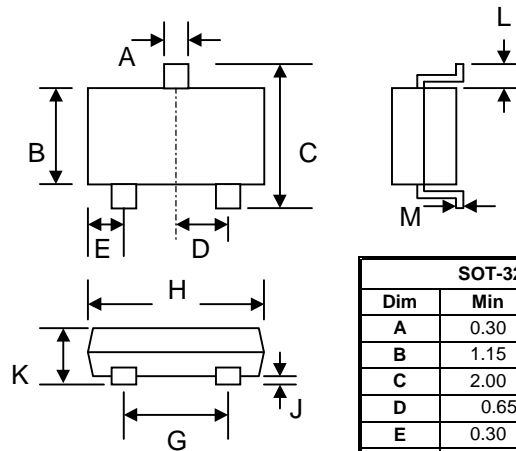

SOT-323		
Dim	Min	Max
A	0.30	0.40
B	1.15	1.35
C	2.00	2.20
D	0.65 Nominal	
E	0.30	0.40
G	1.20	1.40
H	1.80	2.20
J	—	0.10
K	0.90	1.10
L	0.25	—
M	0.05	0.15
All Dimensions in mm		

## Mechanical Data

- Case: SOT-323, Molded Plastic
- Terminals: Plated Leads Solderable per MIL-STD-202, Method 208
- Polarity: See Diagrams Below
- Weight: 0.006 grams (approx.)
- Mounting Position: Any
- **Lead Free: For RoHS / Lead Free Version, Add “-LF” Suffix to Part Number, See Page 4**

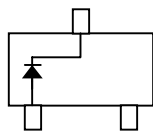

TOP VIEW

BAS40W Marking: S40

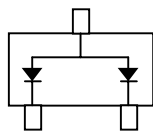

TOP VIEW

BAS40AW Marking: S42

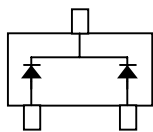

TOP VIEW

BAS40CW Marking: S43

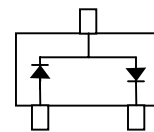

TOP VIEW

BAS40SW Marking: S44

## Maximum Ratings and Electrical Characteristics, Single Diode @<sub>T<sub>A</sub></sub>=25°C unless otherwise specified

Characteristic	Symbol	Value	Unit
Peak Repetitive Reverse Voltage Working Peak Reverse Voltage DC Blocking Voltage	V <sub>RRM</sub> V <sub>RWM</sub> V <sub>R</sub>	40	V
Forward Continuous Current (Note 1)	I <sub>F</sub>	200	mA
Forward Surge Current (Note 1)	I <sub>FSM</sub>	600	mA
Power Dissipation (Note 1)	P <sub>d</sub>	200	mW
Typical Thermal Resistance, Junction to Ambient Air (Note 1)	R <sub>θJA</sub>	625	°C/W
Operating and Storage Temperature Range	T <sub>j</sub> , T <sub>STG</sub>	-55 to +150	°C

Note: 1. Device on fiberglass substrate.

## Maximum Ratings and Electrical Characteristics, Single Diode @ $T_A=25^\circ\text{C}$ unless otherwise specified

Characteristic	Symbol	Min	Typ	Max	Unit	Test Condition
Reverse Breakdown Voltage	$V_{(BR)R}$	40	—	—	V	@ $I_R = 10\mu\text{A}$
Forward Voltage	$V_F$	—	—	380 500 1000	mV	@ $I_F = 1.0\text{mA}$ , $t_p < 300\mu\text{s}$ @ $I_F = 10\text{mA}$ , $t_p < 300\mu\text{s}$ @ $I_F = 40\text{mA}$ , $t_p < 300\mu\text{s}$
Reverse Leakage Current	$I_R$	—	20	200	nA	@ $V_R = 30\text{V}$ , $t_p < 300\mu\text{s}$
Junction Capacitance	$C_j$	—	4.0	5.0	pF	$V_R = 0\text{V}$ , $f = 1.0\text{MHz}$
Reverse Recovery Time	$t_{rr}$	—	—	5.0	nS	$I_F = 10\text{mA}$ through $I_R = 10\text{mA}$ to $I_R = 1.0\text{mA}$ , $R_L = 100\Omega$

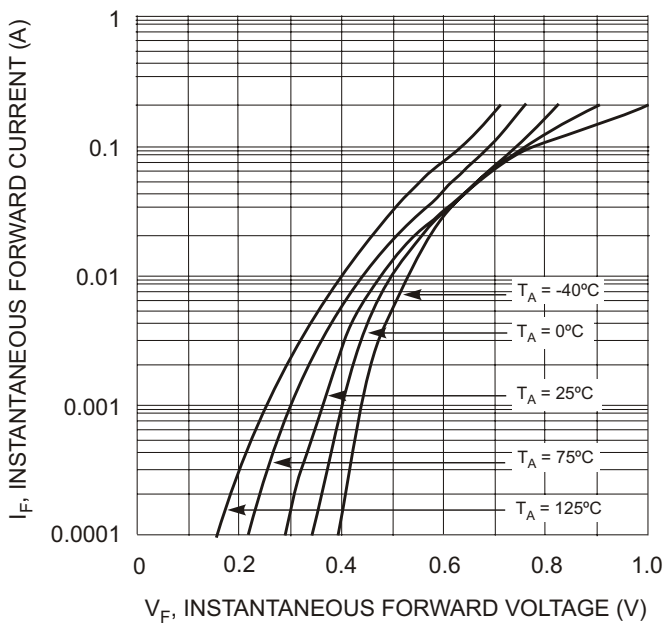

Fig. 1 Typical Forward Voltage

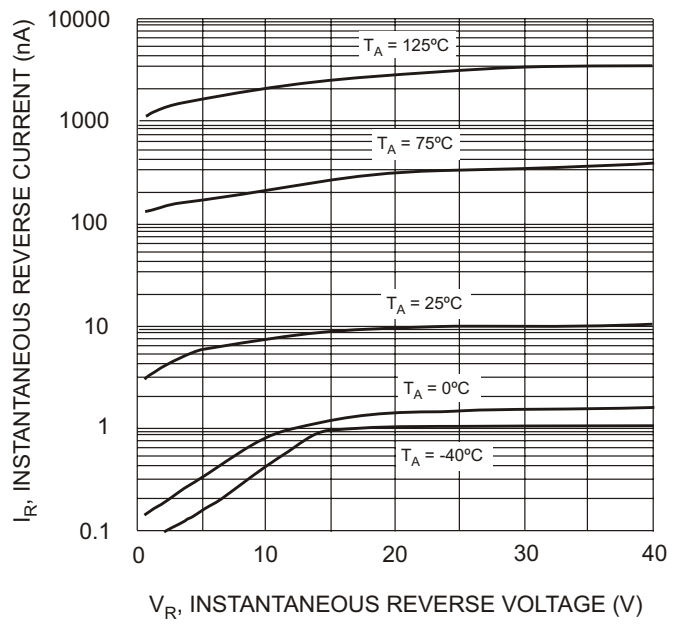

Fig. 2 Typical Reverse Characteristics

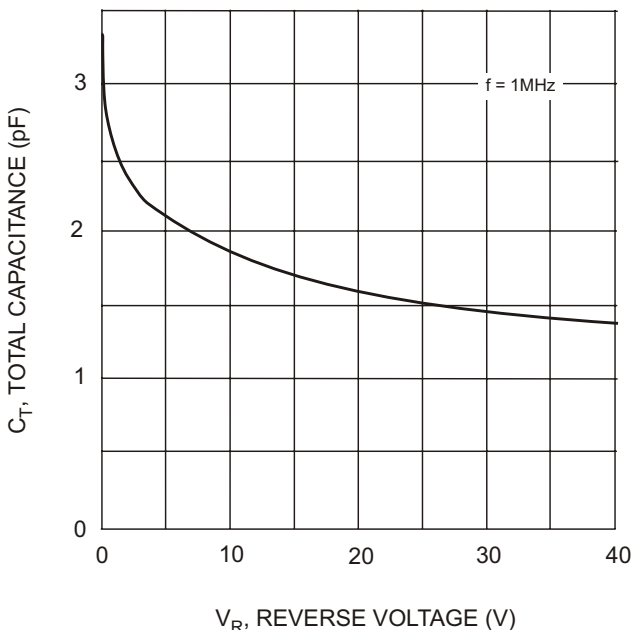

Fig. 3 Typical Capacitance

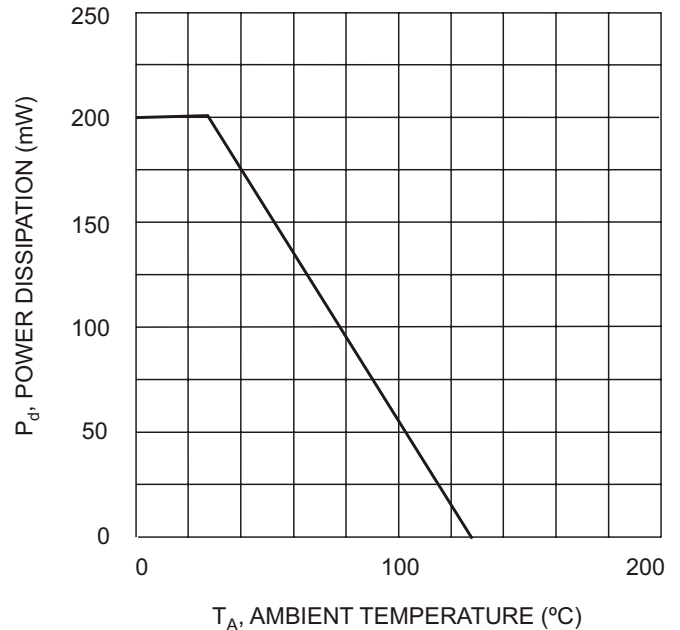
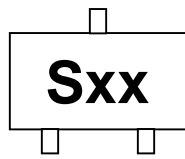

Fig. 4 Power Derating Curve, Total Package

## MARKING INFORMATION



Sxx = Device Code  
 xx = 40 (BAS40W)  
     42 (BAS40AW)  
     43 (BAS40CW)  
     44 (BAS40SW)

## RECOMMENDED FOOTPRINT

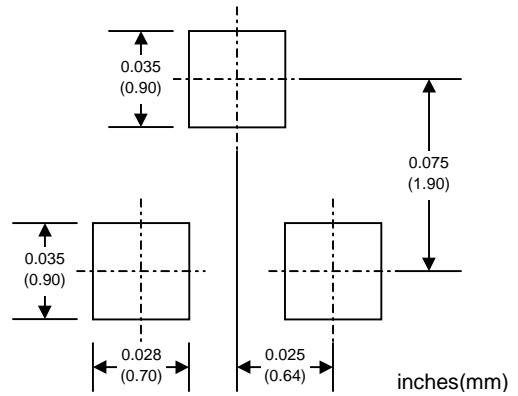

## PACKAGING INFORMATION

### TAPE & REEL

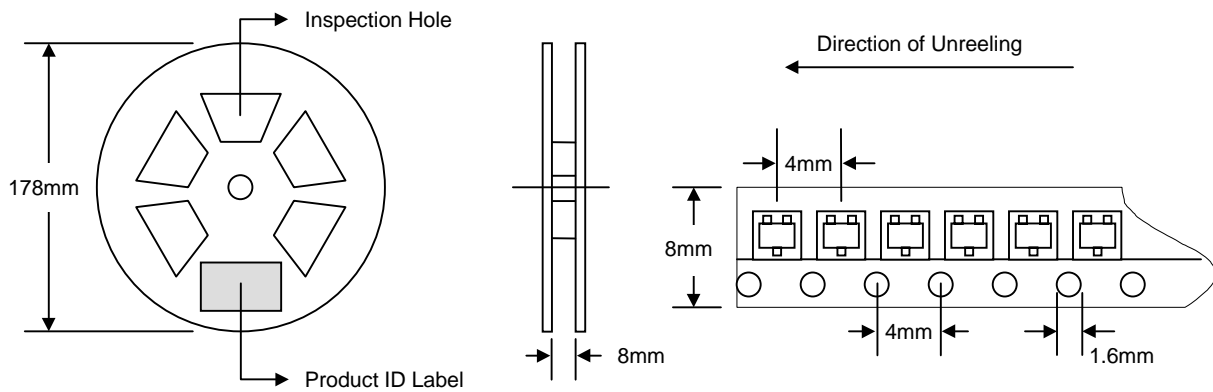

Reel Diameter (mm)	Quantity (PCS)	Inner Box Size L x W x H (mm)	Quantity (PCS)	Carton Size L x W x H (mm)	Quantity (PCS)	Approx. Gross Weight (KG)
178	3,000	187 x 187 x 65	15,000	390 x 240 x 420	150,000	10.0

**Note:** 1. Anti-static plastic reel, white, water clear or blue color. Inspection hole might be varied in different alignment.  
 2. Components are packed in accordance with EIA standard 481-1 and 481-2.

## ORDERING INFORMATION

Product No.	Package Type	Shipping Quantity
BAS40W-T1	SOT-323	3000/Tape & Reel
BAS40AW-T1	SOT-323	3000/Tape & Reel
BAS40CW-T1	SOT-323	3000/Tape & Reel
BAS40SW-T1	SOT-323	3000/Tape & Reel

1. Shipping quantity given is for minimum packing quantity only. For minimum order quantity, please consult the Sales Department.
2. **To order RoHS / Lead Free version (with Lead Free finish), add "-LF" suffix to part number above. For example, BAS40W-T1-LF.**

Won-Top Electronics Co., Ltd (WTE) has checked all information carefully and believes it to be correct and accurate. However, WTE cannot assume any responsibility for inaccuracies. Furthermore, this information does not give the purchaser of semiconductor devices any license under patent rights to manufacturer. WTE reserves the right to change any or all information herein without further notice.

**WARNING:** DO NOT USE IN LIFE SUPPORT EQUIPMENT. WTE power semiconductor products are not authorized for use as critical components in life support devices or systems without the express written approval.

**Won-Top Electronics Co., Ltd.**

No. 44 Yu Kang North 3rd Road, Chine Chen Dist., Kaohsiung, Taiwan

**Phone:** 886-7-822-5408 or 886-7-822-5410

**Fax:** 886-7-822-5417

**Email:** sales@wontop.com

**Internet:** <http://www.wontop.com>

*We power your everyday.*