

SPECIFICATIONS

Switch Function	DP3T
Electrical Ratings	200mA @ 30VDC
Electrical Life	10,000 cycles typical
Contact Resistance	< 50 mΩ initial
Actuation Force	250 +/- 100gF
Actuator Travel	2.0 mm per position 4.0 mm total
Dielectric Strength	1000Vrms min
Insulation Resistance	> 100MΩ min
Operating Temperature	-40°C to 85°C
Storage Temperature	-40°C to 85°C



MATERIALS ←RoHS COMPLIANT

Actuator	Acetal
Housing	Steel
Base	Phenolic
Contacts	Phosphor Bronze, Silver Plated
Terminals	Brass, Silver Plated

ORDERING INFORMATION

1. Series:	MS2305	L6
MS2305		
2. Actuator Length:		
L2 = 2mm		
L4 = 4mm		

DIMENSIONS

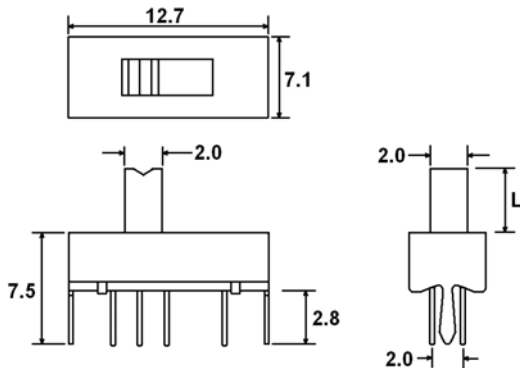

SCHEMATIC & PC LAYOUT

